

General Product Guide 2018

For refrigeration, air conditioning and heat pumps

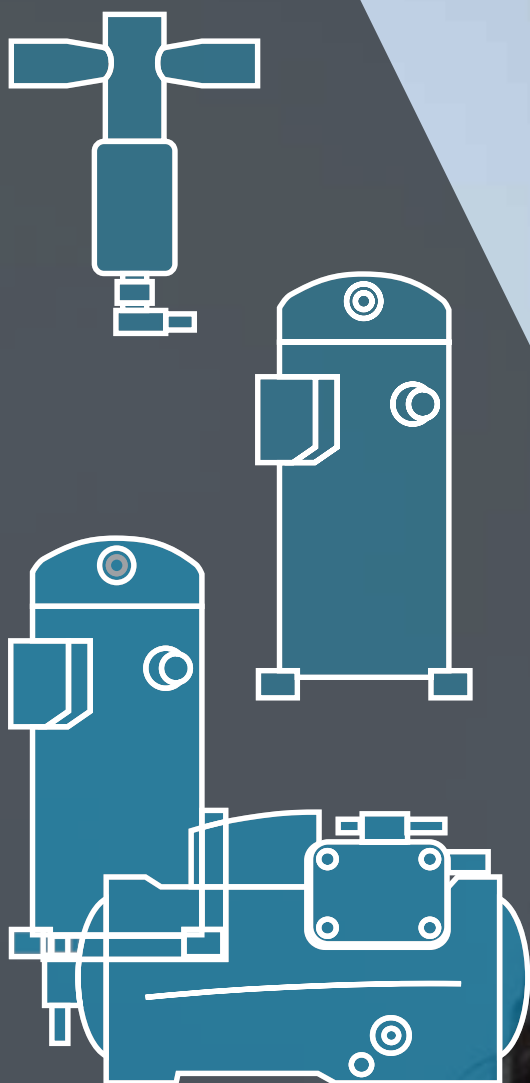

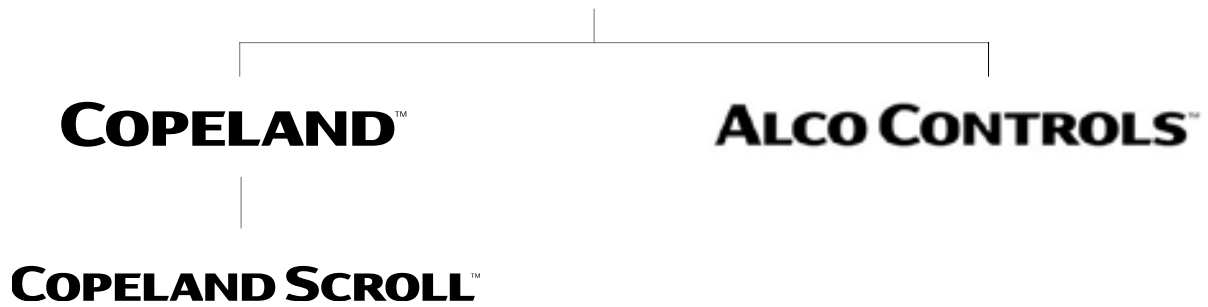

Note

The components listed in this catalogue are not released for use with caustic, poisonous or flammable substances. Emerson Climate Technologies GmbH cannot be held responsible for any damage caused by using these substances.

General Information

Technical data provided herein is collected with scrutiny. However, errors and misprinting remain reserved. The technical data is presented for informational purposes only and they are not to be construed as warranties or guarantees, express or implied, regarding the products or services described or their use or applicability.

Technical data may be updated; should you require confirmation with respect to a specific value, please contact Emerson Climate Technologies GmbH and clearly state the information you require.

Emerson Climate Technologies GmbH and/or its affiliates (collectively "Emerson") shall not be liable for errors in the stated capacities, dimensions, etc., as well as typographic errors. Products, specifications, designs and technical data contained in this document are subject to modification by us without prior notice. Illustrations are not binding.

Emerson does not assume responsibility for the selection, use or maintenance of any product. Responsibility for proper selection, use and maintenance of any product remains solely with the purchaser and end-user.

The information given herein is based on data and tests which Emerson Climate Technologies GmbH believes to be reliable. Such information is intended for use by individuals having the appropriate technical knowledge and skills, at their own discretion and risk. Our products are designed and adapted for stationary application. When using our products in mobile applications, our products might fail. The suitability for such mobile applications has to be assured by the plant manufacturer; for this purpose appropriate tests might be necessary.

Scroll Compressors

- Comfort

• ZR Copeland Scroll™ Compressor Range for R407C and R134a	10
• ZP Copeland Scroll Compressor Range for R410A	14
• ZP Copeland Scroll Air Conditioning Compressor Range, Optimized for Seasonal Performance	18
• ZPD & ZRD Copeland Scroll Digital™ Compressor Ranges for R410A and R407C	20
• XPV & ZPV Copeland Scroll Variable Speed Compressor Ranges for R410A	24
• ZH Copeland Scroll Fixed Speed Compressor Range for R410A and R407C	26
• XHV & ZHW Copeland Scroll Variable Speed Compressor Ranges for R410A	30
• ZH Copeland Scroll For Heat Recovery and High Condensing Applications for R134a	32
• ZRH & ZRHV Copeland Scroll Horizontal Compressor Ranges	34

- Refrigeration

• ZS*KA Copeland Scroll Small Compressor Range for Medium Temperature Applications	40
• ZB Copeland Scroll Compressor Ranges for Medium Temperature Refrigeration	44
• ZF Copeland Scroll Compressor Ranges for Low Temperature Refrigeration	50
• ZFD & ZBD Copeland Scroll Digital Compressor Ranges for Medium and Low Temperature Refrigeration	58
• Emerson Coresense™ Diagnostics for Refrigeration Scrolls	64
• ZO & ZOD Copeland Scroll Compressor Ranges for R744-Subcritical Refrigeration	66
• Sound Shell for Copeland Scroll Compressors	68

Semi-Hermetic Reciprocating Compressors

- K and L Reciprocating Compressor Range	74
- Discus™ Reciprocating Compressor Range	80
- Discus Digital (3Cylinder) Reciprocating Compressor	86
- Copeland™ Stream with CoreSense Diagnostics, Semi-Hermetic Reciprocating Compressors	92
- Copeland Stream Digital with CoreSense Diagnostics for Continuous Capacity Modulation	98
- Copeland Stream Compressors with CoreSense Diagnostics for R744-Transcritical Applications	104
- Copeland Stream Compressors with CoreSense Diagnostics for R744-Subcritical Applications	108
- Service Compressors for 4 and 6 Cylinder S-Series and Discus Reciprocating Compressors	110

Refrigeration Units

- Copeland EazyCool™ Outdoor Refrigeration Units with Scroll Compressors	114
- Copeland EazyCool ZX Outdoor Refrigeration Units with Scroll Compressors	120
- Copeland Outdoor Refrigeration Units for R744-Transcritical Applications	128
- Copeland Scroll Indoor Refrigeration Units for Refrigeration	130
- Copeland Scroll Digital Receiver Unit HLR	144
- Semi-Hermetic Refrigeration Units K/L	150
- Refrigeration Units with Semi-Hermetic Discus Compressors	154
- Refrigeration Units with Semi-Hermetic Stream Compressors and CoreSense Diagnostics	160
- Compressor Motor Codes Table	166

Controls

- Electrical Control Valves	172
- Electronic Controllers and Sensors	184
- Thermo™- Expansion Valves	206
- Solenoid Valves	228
- Mechanical Pressure Regulators	236
- Pressure Controls and Thermostats	242
- System Protectors and Moisture Indicators	264
- Oil Management Components	284
- Suction Accumulators, Ball Valves and Oil Test Kit	296
- Appendix	300
- Alco Keyword Register	306



Pioneering Technologies for Best-in-Class Products

Emerson is a global technology and engineering company providing innovative solutions for customers in industrial, commercial, and residential markets. Emerson Commercial and Residential Solutions, one of Emerson's business platforms, provides advanced solutions for heating, ventilation, air conditioning and refrigeration, while ensuring human comfort and health, protecting food quality and safety, advancing energy efficiency, and creating sustainable infrastructure.

For more than 80 years we have been introducing innovative technology to the market, from the first semi-hermetic and hermetic compressors in the 1940s and 1950s, over the high efficiency Discus, air conditioning and heating scroll compressors in the 1980s and 1990s, to the new Stream semi-hermetic compressors, the digital scroll compressor and the variable speed scroll with drive technology of today.

Based on this, we have developed an unequalled range of solutions for the refrigeration and air conditioning markets. In recent years, we have become a major solutions provider to the heat pump industry. Our range of Copeland™ brand compressors is engineered for higher efficiency, lower sound levels, superior durability and unsurpassed reliability. They allow the integration of new and environmentally-friendly refrigerants into your systems, while seamlessly improving efficiency and performance levels. Alco Controls™ is the leading provider of precision mechanical controls for the refrigeration and air conditioning markets, and together with the range of Emerson electronic controls we continue to pioneer the control of refrigerant flow with innovative design, keeping system performance optimization central to our product development.

More than 1,250 employees develop and deliver Emerson's high-class technology and manufacture our products in four European plants: Belgium, Northern Ireland and the Czech Republic (two plants). R&D centers in Welkenraedt (Belgium) and Mikulov (Czech Republic) enable new developments not only to meet our customers' requirements, but also to redefine the limits of technology.

With sales offices in Germany, France, Spain, Italy, the United Kingdom, Scandinavia, Benelux, Poland, as well as in Eastern Europe and Russia, Emerson supports its European customers in a lean and efficient manner, supporting the industry with advanced technology, technical support and training services.



Our 2018 product catalogue gives a comprehensive overview of Emerson, Copeland brand and Alco Controls products. Take a look and discover our broad product ranges including these innovations:

- Next generation of 20 and 25hp ZP*KZE and 30 and 40 hp ZP*KPE R410A compact scrolls with optimized seasonal performance, for efficient and reliable large chillers
- New commercial variable speed models with their matched inverter drive for superior performance when designing reversible chillers, heat pumps, precision cooling systems or rooftops
- New variable speed scrolls and their matched drives for residential applications
- The extended range of 4-cylinder Stream compressors for R744 transcritical and subcritical applications
- The CS3 series of safety pressure switches with fixed switch point settings for CO₂ applications.
- The EXD-SH1/2 superheat controller controller, specifically designed for Emerson EX and CX electrical control valves in high-pressure CO₂ / high MOPD applications.

More in-depth technical data is available through our user-friendly Copeland and Alco selection software tools accessible via our web page www.emersonclimate.eu. For individual consultancy and service please contact your European sales office.



Copeland Scroll™ Compressors

With the launch of scroll technology in the mid 1980s, Emerson revolutionized the market setting new standards in the air conditioning industry. Since then, Copeland Scroll has become the reference not only in air conditioning but in refrigeration and heating applications too. Thousands of customers trust our proprietary technology: today, over 100 million Copeland Scrolls are installed worldwide, more than any other scroll compressor brand. Copeland Scroll compressors range from 1.5 to 60 hp and are designed to work with all the main refrigerants, including CO₂. With compressors built in both vertical and horizontal versions and capable of digital modulation, Emerson has expanded the capability of scroll technology to new heights.

Additional innovations such as Enhanced Vapor Injection, the new Variable Speed scroll with drive technology for heat pump compressors or the design of the Emerson sound shell give manufacturers,

installers and end users the right tools to reduce the carbon footprint of their installations, optimize system design, efficiency, sound and reliability, while ensuring long equipment lifetime and minimizing capital and operating costs.

Applications for scroll compressors continue to grow thanks to innovation and adaptation. Industry as a whole has embraced its responsibility to put the environment first in its list of priorities, and this has led to strategic imperatives such as the need to introduce larger capacity scrolls with improved seasonal performance, modulated systems and product designed for use with “green” refrigerants such as CO₂. Emerson is staying abreast of these challenges by successfully further developing its technologies in each of these areas.





Comfort Applications

Comfort Applications

For decades, Emerson has driven advancement in the air conditioning and heat pump industry, leading the field with engineering products and systems that maximize the comfort of office and living spaces – while minimizing costs and inefficiencies.

Copeland Scroll™ compressors are designed to deliver the highest performance in residential and commercial applications. Thanks to the widest selection of scroll compressors optimized for air conditioning and heating, it has never been easier to match all desired applications with the highest efficiency and reliability. The capacity of our single scrolls ranges from 1.5 to 60hp and they can reach an overall capacity of 180 hp per circuit when combined in even and uneven tandems and trios. Whether your need is a cooling optimized, heating optimized or reversible unit, you will find the most advanced technology within our range.

One of the most important recent innovations for comfort applications has been the introduction of Variable Speed technology. It was first introduced with the ZHW compressors (featuring Enhanced Vapor Injection), as a solution for residential heat pump applications. Now we also offer the XHV range for cost-competitive heating systems. In addition to the ZHW and XHV ranges for residential applications, a wide range of models for reversible and low temperature commercial applications are available, from 18 to 96 cm³: XPV and ZPV Variable Speed scroll compressors allow system manufacturers and building owners to achieve superior performance when designing reversible chillers, heat pumps, precision cooling systems or rooftops.

Emerson is introducing the next generation of 20 and 25hp ZP*KZE and 30 and 40 hp ZP*KPE compact scrolls for R410A with advanced monitoring features and optimized seasonal performance.

ZR Copeland Scroll™ Compressor Range for R407C and R134a

ZR Copeland Scroll compressors, for R407C and R134a, for comfort and process/precision cooling applications.

Applied in the air conditioning and comfort industry for water chillers, rooftops and close control unit applications, scroll compressors are now the most used compression technology replacing reciprocating and screw compressors due to its undeniable superiority. Several, fully Copeland™ qualified, multiple compressor assemblies (tandem and trio) are available to allow the use of Copeland Scroll compressors into large capacity systems (ex. up to 500kW air cooled chillers) able to deliver optimal comfort, low operating cost with higher seasonal efficiency (ESEER).

The range of products goes from the ZR18 (1.5hp) to the ZR380 (30hp)



ZR Scroll Compressor

ZR Scroll Compressor Line-up R407C

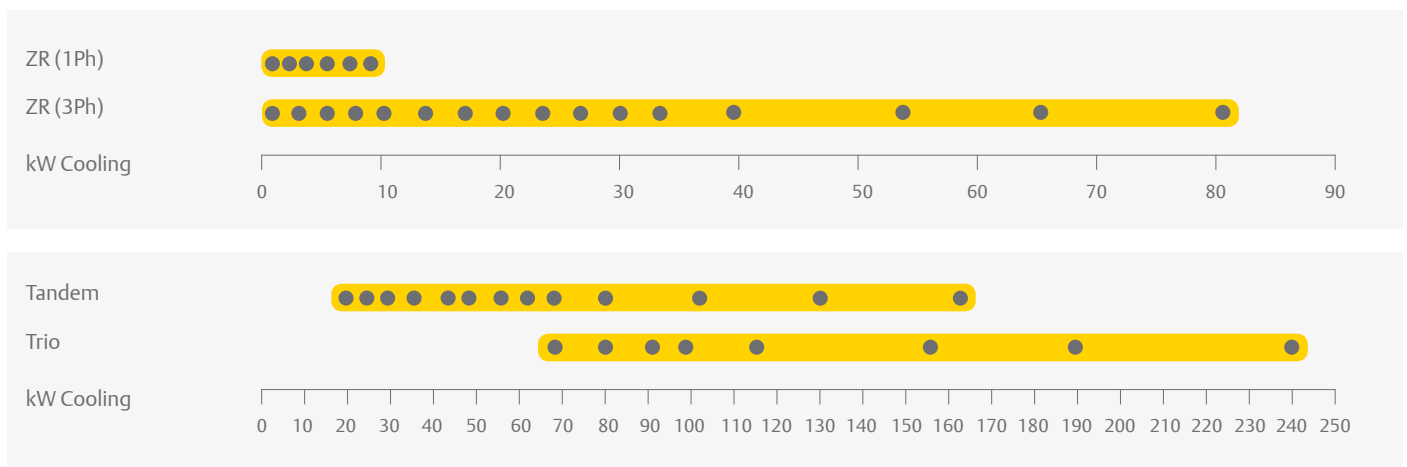

Conditions EN12900: Evaporating 5°C, Condensing 50°C, Superheat 10K, Subcooling 0K

Features and Benefits

- Copeland Scroll axial and radial compliance for superior reliability and efficiency
- Wide scroll line-up for R407C and R134a
- Low TEWI (Total Equivalent Warming Impact)
- Low sound and vibration level
- Low oil circulation rate
- Copeland qualified tandem and trio configurations for superior seasonal efficiency (ESEER)

Maximum Allowable Pressure (PS)

- ZR18 to ZR81:
Low side PS 20 bar(g) / High Side PS 29.5 bar(g)
- ZR94 to ZR380:
Low side PS 20 bar(g) / High Side PS 32 bar(g)

Operating Envelope R407C

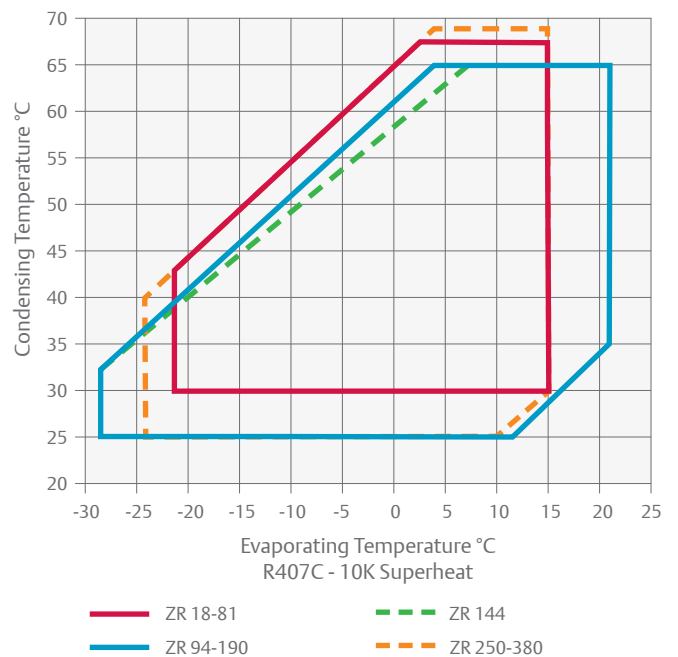

Operating Envelope R134a

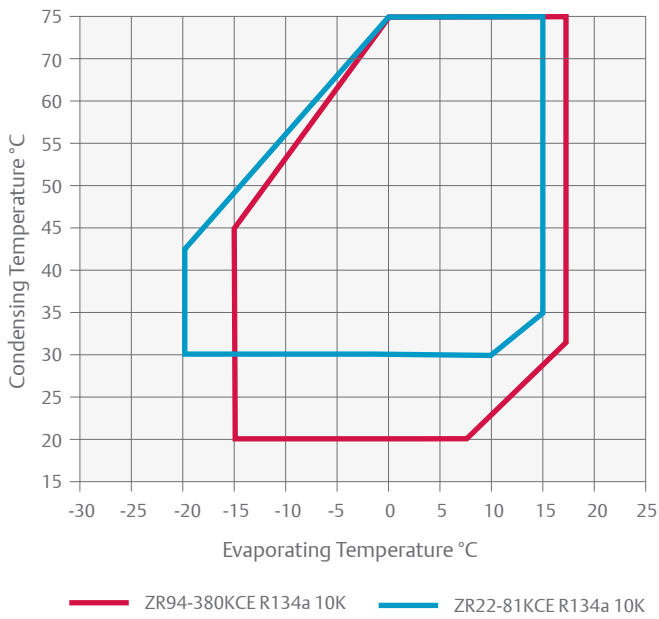

Technical Overview

Models	Nominal hp	R407C Capacity (kW)	COP	Displacement (m ³ /h)	Stub Suction (inch)	Stub Discharge (inch)	Oil Quantity (l)	Length/Width/Height (mm)	Net Weight (kg)	Motor Version/Code		Maximum Operating Current (A)		Locked Rotor Current (A)		Sound Pressure @1 m - dB(A) ***
										1 Ph*	3 Ph**	1 Ph*	3 Ph**	1 Ph*	3 Ph**	
ZR18K5E	1.5	3.7	3.0	4.4	3/4	1/2	0.74	242/242/383	20	PFJ		10		35		54
ZR22K3E	2.0	4.5	2.9	5.3	3/4	1/2	1.00	242/242/363	22	PFJ	TFD	11	4	47	24	54
ZR28K3E	2.5	5.9	2.9	6.8	3/4	1/2	1.00	242/242/363	25	PFJ	TFD	15	5	61	32	54
ZR34K3E	2.8	7.0	3.0	8.0	3/4	1/2	1.10	242/242/386	26	PFJ	TFD	17	6	76	40	57
ZR40K3E	3.5	8.2	3.0	9.4	3/4	1/2	1.10	242/242/400	27	PFJ	TFD	23	7	100	v 46	57
ZR48K3E	4.0	10.1	3.1	11.4	7/8	1/2	1.36v	242/242/417	31	PFJ	TFD	23	10	114	50	57
ZR61KCE	5.0	12.5	3.1	14.4	7/8	1/2	1.66	241/247/438	43	PFJ	TFD	30	11	150	65	60
ZR61KSE	5.0	12.8	3.2	14.4	7/8	1/2	1.42	242/242/430	30	PFZ	TFM		11		59	61
ZR72KCE	6.0	14.8	3.2	17.1	7/8	1/2	1.77	242/242/438	39		TFD		13		74	61
ZR81KCE	6.8	16.7	3.2	18.7	7/8	3/4	1.77	242/242/443	39		TFD		15		101	61
ZR94KCE	8.0	20.6	3.3	22.1	1 1/8	7/8	2.65	264/285/476	57		TFD		16		t95	63
ZR108KCE	9.0	23.0	3.4	24.9	1 3/8	7/8	3.38	264/285/533	60		TFD		17		111	63
ZR125KCE	10.0	27.0	3.4	29.1	1 3/8	7/8	3.38	264/285/533	61		TFD		19		118	63
ZR144KCE	12.0	30.9	3.4	33.2	1 3/8	7/8	3.38	264/285/533	61		TFD		22		118	64
ZR160KCE	13.0	33.4	3.2	36.4	1 3/8	7/8	3.38	264/285/552	65		TFD		28		140	67
ZR190KCE	15.0	39.3	3.2	43.3	1 3/8	7/8	3.38	264/285/552	66		TFD		34		174	69
ZR250KCE	20.0	52.2	3.2	56.6	1 5/8	1 3/8	4.70	432/376/717	140		TWD		41		225	72
ZR310KCE	25.0	65.0	3.2	71.4	1 5/8	1 3/8	6.80	448/392/715	160		TWD		52		272	74
ZR380KCE	30.0	81.7	3.4	87.4	1 5/8	1 3/8	6.30	447/427/715	177		TWD		62		310	76

Conditions EN12900 : Evaporating 5°C, Condensing 50°C, Superheat 10K, Subcooling 0K

* 1 Ph: 230V/ 50Hz

** 3 Ph: 380-420V/ 50Hz

*** @ 1m: sound pressure level at 1m distance from the compressor, free field condition

Capacity Data

Condensing Temperature +40°C															
R134a	Cooling Capacity (kW)							R134a	Power Input (kW)						
	Evaporating Temperature (°C)								Evaporating Temperature (°C)						
Model	-15	-10	-5	0	+5	+10	+15	Model	-15	-10	-5	0	+5	+10	+15
ZR22K3E	1.4	1.8	2.3	2.9	3.6	4.4	5.3	ZR22K3E	0.9	0.9	0.9	0.9	0.9	0.8	0.8
ZR28K3E	1.8	2.3	3.0	3.8	4.7	5.7	6.9	ZR28K3E	1.1	1.2	1.1	1.1	1.1	1.1	1.1
ZR34K3E	2.2	2.9	3.6	4.5	5.5	6.7	8.1	ZR34K3E	1.4	1.4	1.4	1.3	1.3	1.3	1.3
ZR40K3E	2.5	3.3	4.2	5.2	6.4	7.8	9.3	ZR40K3E	1.6	1.5	1.5	1.5	1.5	1.5	1.5
ZR48K3E	3.1	4.0	5.1	6.3	7.8	9.5	11.5	ZR48K3E	1.8	1.8	1.8	1.8	1.8	1.8	1.8
ZR61KCE	4.0	5.2	6.5	8.1	9.9	12.1	14.6	ZR61KCE	2.1	2.1	2.2	2.2	2.2	2.2	2.3
ZR72KCE	4.8	6.2	7.8	9.7	11.9	14.5	17.4	ZR72KCE	2.6	2.6	2.6	2.6	2.6	2.6	2.7
ZR81KCE	5.5	7.0	8.8	10.8	13.2	16.0	19.2	ZR81KCE	2.8	2.9	2.9	2.9	2.9	3.0	3.0
ZR94KCE	5.3	7.5	10.5	13.0	15.9	19.2	23.0	ZR94KCE	3.4	3.4	3.4	3.4	3.4	3.4	3.5
ZR108KCE	7.3	9.3	11.7	14.3	17.5	21.3	25.7	ZR108KCE	3.7	3.8	3.8	3.8	3.8	3.9	3.9
ZR125KCE	8.3	10.7	13.5	16.7	20.5	24.9	30.1	ZR125KCE	4.3	4.4	4.4	4.4	4.4	4.5	4.5
ZR144KCE	10.4	13.3	16.5	20.0	23.7	27.8	32.4	ZR144KCE	4.7	4.9	4.9	5.0	5.0	5.2	5.5
ZR160KCE	10.1	13.3	16.9	21.0	25.7	31.2	37.5	ZR160KCE	5.5	5.5	5.5	5.6	5.7	5.8	5.9
ZR190KCE	12.3	16.0	20.2	25.0	30.7	37.2	44.7	ZR190KCE	6.8	6.9	6.9	7.0	7.0	7.1	7.3
ZR250KCE	16.1	20.5	25.6	31.8	39.0	47.4	57.2	ZR250KCE	8.6	8.7	8.9	9.0	9.1	9.2	9.4
ZR310KCE	20.0	25.6	32.1	39.7	48.6	59.0	71.1	ZR310KCE	10.6	10.8	10.9	10.0	11.2	11.5	11.7
ZR380KCE	25.5	32.2	40.1	49.4	60.3	73.0	87.8	ZR380KCE	12.6	12.9	13.1	13.4	13.6	14.0	14.4

Conditions: Suction Superheat 10K / Subcooling 0K

Condensing Temperature +40°C															
R407C	Cooling Capacity (kW)							R407C	Power Input (kW)						
	Evaporating Temperature (°C)								Evaporating Temperature (°C)						
Model	-15	-10	-5	0	+5	+10	+15	Model	-15	-10	-5	0	+5	+10	+15
ZR18K5E	1.8	2.3	2.8	3.5	4.2	5.1	6.1	ZR18K5E	1.0	1.0	1.0	1.0	1.0	1.0	1.0
ZR22K3E	2.1	2.7	3.4	4.2	5.2	6.3	7.5	ZR22K3E	1.2	1.2	1.2	1.2	1.2	1.2	1.1
ZR28K3E	2.7	3.5	4.4	5.5	6.7	8.1	9.6	ZR28K3E	1.6	1.6	1.6	1.5	1.5	1.5	1.5
ZR34K3E	3.2	4.1	5.2	6.5	7.9	9.6	11.5	ZR34K3E	1.8	1.8	1.8	1.8	1.8	1.8	1.7
ZR40K3E	3.8	4.9	6.1	7.6	9.4	11.3	13.5	ZR40K3E	2.2	2.2	2.2	2.1	2.1	2.1	2.0
ZR48K3E	4.8	6.1	7.6	9.4	11.5	13.8	16.6	ZR48K3E	2.6	2.6	2.6	2.6	2.6	2.5	2.5
ZR61KSE	6.5	8.1	9.9	11.9	14.4	17.2	20.6	ZR61KsE	3.0	3.0	3.1	3.2	3.2	3.1	2.9
ZR72KCE	7.0	9.0	11.3	13.9	16.9	20.3	24.2	ZR72KCE	3.6	3.7	3.7	3.7	3.7	3.7	3.8
ZR81KCE	7.8	10.1	12.7	15.6	19.1	23.0	27.7	ZR81KCE	4.1	4.1	4.1	4.1	4.2	4.2	4.3
ZR94KCE	9.8	12.6	15.8	19.3	23.3	27.9	33.1	ZR94KCE	4.9	5.0	5.0	5.0	5.0	4.9	4.9
ZR108KCE	11.3	14.2	17.6	21.5	26.2	31.5	37.6	ZR108KCE	5.4	5.4	5.5	5.5	5.5	5.6	5.7
ZR125KCE	13.1	16.6	20.5	25.2	30.5	36.7	43.7	ZR125KCE	6.3	6.3	6.4	6.4	6.4	6.5	6.6
ZR144KCE	14.5	18.7	23.4	28.9	35.0	42.0	50.1	ZR144KCE	7.1	7.1	7.2	7.2	7.3	7.3	7.4
ZR160KCE	14.9	19.5	24.9	31.3	38.7	47.3	57.1	ZR160KCE	8.0	8.1	8.2	8.2	8.3	8.4	8.5
ZR190KCE	18.5	23.8	29.8	36.7	44.7	53.8	64.2	ZR190KCE	9.7	9.7	9.8	9.8	9.9	10.1	10.4
ZR250KCE	25.7	32.2	39.9	48.9	59.3	71.3	85.0	ZR250KCE	12.5	12.6	12.7	12.9	13.0	13.0	13.0
ZR310KCE	31.2	39.7	49.7	61.4	75.0	90.7	108.5	ZR310KCE	15.6	15.7	15.9	16.1	16.3	16.6	17.0
ZR380KCE	38.1	49.1	61.7	76.2	93.1	113.0	136.5	ZR380KCE	18.6	18.8	19.0	19.2	19.4	19.8	20.3

Conditions: Suction Superheat 10K / Subcooling 0K

Tandem Model Overview

Model	Nominal hp	Cooling Capacity R407C (kW)	Even Tandem	Uneven Tandem
Tandem ZRT - Tandem Uneven ZRU				
ZRT 96 K3E	2 x 4	20	•	
ZRT 122 KSE	2 x 5	25	•	
ZRT 144 KCE	2 x 6	30	•	
ZRT 162 KCE	2 x 6.5	33	•	
ZRT 188 KCE	2 x 8	41	•	
ZRT 216 KCE	2 x 9	46	•	
ZRT 250 KCE	2 x 10	52	•	
ZRT 288 KCE	2 x 12	59	•	
ZRU 315 KCE*	10 + 15	66		•
ZRT 320 KCE	2 x 13	67	•	
ZRU 350 KCE*	13 + 15	73		•
ZRT 380 KCE	2 x 15	78	•	
ZRU 440 KCE*	15 + 20	92		•
ZRT 500 KCE*	2 x 20	104	•	
ZRU 500 KCE*	15 + 25	104		•
ZRU 560 KCE*	20 + 25	117		•
ZRT 620 KCE*	2 x 25	130	•	
ZRU 690 KCE*	25 + 30	147		•
ZRT 760 KCE*	2 x 30	163	•	

Conditions EN 12900: Evaporating 5°C, Condensing 50°C, Superheat 10K, Subcooling 0K

* Tandem Assemblies by System Manufacturers. Emerson Can Provide Full Technical Support.

ZP Copeland Scroll™ Compressor Range for R410A

ZP Copeland Scroll compressors, for R410A, for comfort and process precision cooling applications. Emerson has been the pioneer in launching the first complete line-up of R410A commercial scroll compressors.

ZP Copeland Scroll compressors are perfectly suitable for air-cooled chiller systems up to 900kW (1100 kW if water-cooled) featuring high comfort and superior seasonal efficiency (ESEER). Whether used in stand-alone, tandem or trio configurations, the broad ZP Copeland Scroll line-up meets today's market requirements with unmatched flexibility, efficiency and proven reliability.

ZP104, ZP122 and ZP143KCE compressors for light commercial systems have a reduced footprint and weight for more compact systems. Their high efficiency helps to reduce operating costs.



ZP Scroll Compressor

ZP Scroll Compressor Line-up

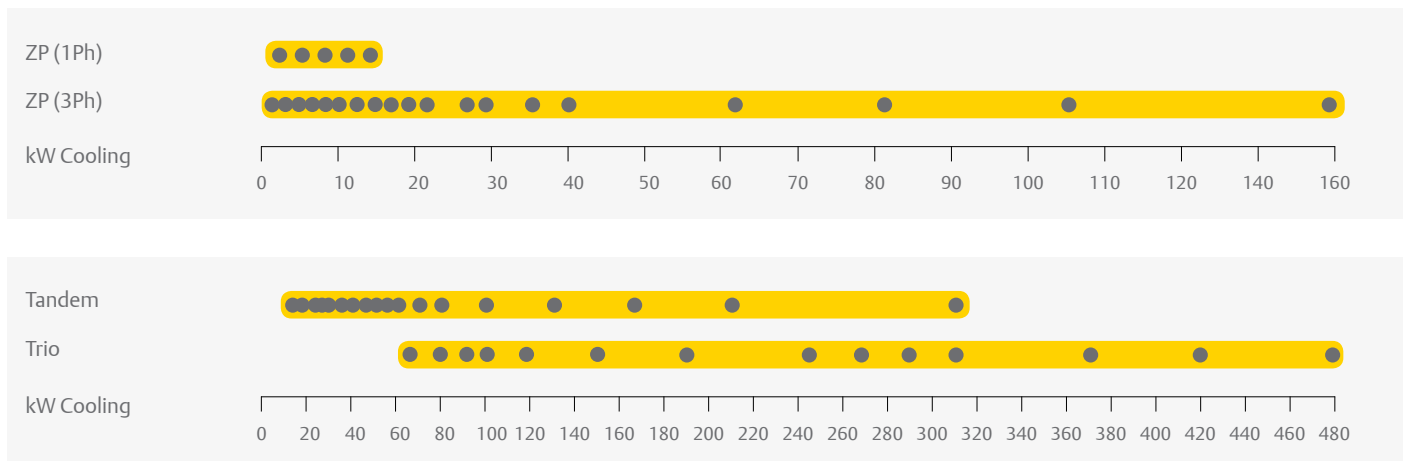

Conditions EN12900: Evaporating 5°C, Condensing 50°C, Superheat 10K, Subcooling 0K

Features and Benefits

- Copeland qualified tandem and trio (now also uneven) configurations for superior seasonal efficiency (ESEER and EN14825: SEER and SCOP)
- Copeland Scroll axial and radial compliance for superior reliability and efficiency
- Extended 5K operating envelope suitable for heat pump applications
- Low TEWI (Total equivalent warming impact)
- Wide scroll line-up for R410A
- Low sound and vibration level
- Low oil circulation rate

Maximum Allowable Pressure (PS)

- ZP24 to ZP91:
Low side PS 28 bar(g) / High side PS 43 bar(g)
- ZP104 to ZP725:
Low side PS 29.5 bar(g) / High side PS 45 bar(g)

Operating Envelope R410A

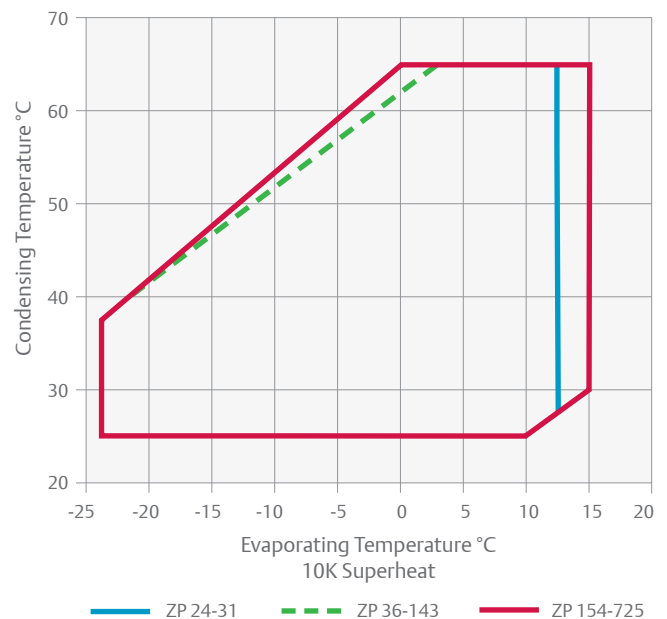

Technical Overview

Models	Nominal hp	Capacity (kW)	COP	Displacement (m ³ /h)	Stub Suction (inch)	Stub Discharge (inch)	Oil Quantity (l)	Length/width/height (mm)	Net Weight (kg)	Motor Version/Code		Maximum Operating Current (A)		Locked Rotor Current (A)		Sound Pressure @1 m - dB(A) ***
										1 Ph*	3 Ph**	1 Ph*	3 Ph**	1 Ph*	3 Ph**	
ZP24K5E	1.9	5.1	2.8	3.9	3/4	1/2	0.74	242/242/387	22	PFJ	TFD	13	5	60	28	55
ZP29K5E	2.2	6.1	2.9	4.8	3/4	1/2	0.74	242/242/387	23	PFJ	TFD	16	6	67	38	55
ZP31K5E	3.0	6.5	2.8	5.0	3/4	1/2	0.74	242/242/388	23	PFJ	TFD	17	6	67	38	55
ZP36K5E	2.6	7.9	3.0	6.0	7/8	1/2	1.25	242/242/418	30	PFJ	TFD	22	7	98	46	57
ZP42K5E	3.4	9.0	2.9	6.9	7/8	1/2	1.25	242/242/418	31	PFJ	TFD	26	8	128	43	57
ZP54K5E	4.6	11.6	3.0	8.9	7/8	1/2	1.24	242/242/418	34	PFJ	TFD	31	10	115	51	59
ZP61K5E	5.0	13.3	3.0	10.0	7/8	1/2	1.24	246/246/443	35		TFD		12		64	60
ZP72KCE	6.0	15.3	3.0	11.7	7/8	1/2	1.77	246/246/443	40		TFD		15		75	64
ZP83KCE	6.5	17.7	3.1	13.4	7/8	1/2	1.77	246/246/443	40		TFD		15		101	61
ZP91KCE	7.5	19.3	3.1	14.7	7/8	3/4	1.77	246/248/446	41		TFD		16		101	61
ZP104KCE	9.0	22.7	3.2	16.8	1 1/8	7/8	2.51	264/284/476	48		TFD		18		128	63
ZP122KCE	10.0	26.5	3.2	19.5	1 1/8	7/8	2.51	293/258/559	49		TFD		22		139	63
ZP143KCE	12.0	31.6	3.2	23.1	1 3/8	7/8	2.75	297/262/559	49		TFD		25		145	64
ZP154KCE	13.0	33.5	3.2	24.8	1 3/8	7/8	3.38	329/298/552	65		TFD		31		140	65
ZP182KCE	15.0	39.6	3.2	29.1	1 3/8	7/8	3.38	264/284/552	66		TFD		34		174	66
ZP385KCE	30.0	82.4	3.2	60.8	1 5/8	1 3/8	6.30	448/392/715	178		TWD		65		310	74
ZP485KCE	40.0	105.0	3.2	77.3	1 5/8	1 3/8	6.30	391/447/746	190		TWD		82		408	78
ZP725KCE	60.0	160.0	3.2	115	2 1/8	1 3/8	6.30	459/483/863	250		FED		124		567	78

Conditions EN12900 : Evaporating 5°C, Condensing 50°C, Superheat 10K, Subcooling 0K

* 1 Ph: 230V/ 50Hz

** 3 Ph: 380-420V/ 50Hz

*** @ 1m: sound pressure level at 1m distance from the compressor, free field condition

Preliminary Data

Capacity Data

Condensing Temperature +40°C															
R410A	Cooling Capacity (kW)							R410A	Power Input (kW)						
	Evaporating Temperature (°C)								Evaporating Temperature (°C)						
Model	-15	-10	-5	0	+5	+10	+15	Model	-15	-10	-5	0	+5	+10	+15
ZP24K5E	2.2	3.0	3.9	4.9	5.9	7.1		ZP24K5E	1.5	1.5	1.4	1.4	1.4	1.3	
ZP29K5E	2.9	3.9	4.9	6.0	7.3	8.6		ZP29K5E	1.8	1.8	1.7	1.7	1.7	1.6	
ZP31K5E	3.2	4.1	5.2	6.3	7.6	9.1		ZP31K5E	1.9	1.9	1.9	1.8	1.8	1.8	
ZP36K5E	4.1	5.1	6.3	7.7	9.2	11.0		ZP36K5E	2.2	2.1	2.1	2.1	2.1	2.1	
ZP42K5E	4.4	5.7	7.1	8.7	10.5	12.5		ZP42K5E	2.4	2.4	2.4	2.4	2.3	2.3	
ZP54K5E	6.0	7.5	9.3	11.3	13.5	16.0		ZP54K5E	3.1	3.1	3.0	3.0	2.9	2.9	
ZP61K5E	6.9	8.6	10.6	12.9	15.5	18.4	21.4	ZP61K5E	3.5	3.5	3.4	3.4	3.4	3.4	3.4
ZP72KCE	8.2	10.1	12.3	14.8	17.7	20.9		ZP72KCE	4.0	4.0	4.0	4.0	4.1	4.1	
ZP83KCE	9.4	11.6	14.2	17.1	20.4	24.2		ZP83KCE	4.5	4.5	4.5	4.6	4.6	4.7	
ZP91KCE	10.2	12.6	15.4	18.6	22.2	26.3	31.0	ZP91KCE	4.9	4.9	4.9	5.0	5.0	5.0	5.3
ZP104KCE	12.0	14.9	18.1	21.9	26.1	31.0	36.5	ZP104KCE	5.7	5.7	5.7	5.7	5.8	5.8	5.9
ZP122KCE	14.1	17.4	21.2	25.5	30.4	36.1	42.4	ZP122KCE	6.6	6.6	6.7	6.7	6.7	6.8	6.9
ZP143KCE	15.9	20.3	25.2	30.5	36.1	41.9	47.8	ZP143KCE	7.5	7.7	7.8	7.9	8.1	8.4	8.8
ZP154KCE	18.2	22.3	27.1	32.6	38.9	46.1	54.3	ZP154KCE	8.1	8.2	8.2	8.3	8.3	8.5	8.8
ZP182KCE	21.4	26.3	32.0	38.4	45.6	53.9	63.3	ZP182KCE	9.5	9.7	9.9	10.0	10.1	10.1	10.0
ZP385KCE	43.7	53.9	65.8	79.5	95.2	113.0	133.5	ZP385KCE	20.3	20.4	20.5	20.7	20.9	21.3	21.7
ZP485KCE	57.5	70.0	84.7	101.6	121.0	143.0	168.0	ZP485KCE	24.9	25.3	25.8	26.3	27.0	27.8	28.8
ZP725KCE	88.0	107.0	129.0	154.0	182.0	215.0	252.0	ZP725KCE	39.0	39.6	40.0	40.0	40.7	41.3	41.1

Conditions: Suction Superheat 10K / Subcooling 0K

Preliminary Data

Tandem Model Overview

Model	Nominal hp	Cooling Capacity (kW)	Even Tandem	Uneven Tandem
Tandem ZPT - Tandem Uneven ZPU				
ZPT 72 K5E*	2 x 3	16	•	
ZPT 84 K5E*	2 x 3.5	18	•	
ZPT 108 K5E*	2 x 4	23	•	
ZPT 122 K5E*	2 x 5	26	•	
ZPT 144 KCE*	2 x 6	31	•	
ZPT 166 KCE*	2 x 6.5	35	•	
ZPT 182 KCE*	2 x 8	39	•	
ZPT 208 KCE*	2 x 9	45	•	
ZPT 244 KCE*	2 x 10	53	•	
ZPT 286KCE	2 x 12	63	•	
ZPT 308KCE*	2 x 13	67	•	
ZPU 336 KCE*	13 + 15	73		•
ZPT 364 KCE*	2 x 15	79	•	
ZPU 417 KCE*	15 + 20	90		•
ZPT 470 KCE*	2 x 20	101	•	
ZPU 477 KCE*	15 + 25	103		•
ZPU 530 KCE*	20 + 25	114		•
ZPT 590 KCE*	2 x 25	127	•	
ZPU 680 KCE*	25 + 30	146		•
ZPT 770 KCE*	2 x 30	165	•	
ZPU 870 KCE*	30 + 40	187		•
ZPT 970 KCE*	2 x 40	209	•	
ZPU 111 MCE*	30 + 60	240		•
ZPU 121 MCE*	40 + 60	262		•
ZPT 145 MCE*	60 + 60	317	•	

System using ZP235 or ZP295 (20 or 25 hp) shall use the new ZP232KZE and ZP292KZE (refer to next chapter)

Conditions EN 12900: Evaporating 5°C, Condensing 50°C, Superheat 10K, Subcooling 0K

* Tandem assemblies by system manufacturers. Emerson can provide full technical support.

ZP Copeland™ Scroll Air Conditioning Compressor Range, Optimized for Seasonal Performance

The new ZP*KZE and ZP*KPE scroll compressors for large chillers feature advanced monitoring capabilities and improved part-load cooling efficiency, thanks to VVR technology. This will help OEMs meet the minimum seasonal performance level required by the Ecodesign Directive.

The CoreSense Communications module they are equipped with ensures enhanced reliability, by providing real time compressor data to the system controller to provide temperature protection.

They are designed for reversible chillers, rooftop or air handling units with a cooling capacity between 30 and 400 kW.



ZP*KZE Scroll Compressor

ZP*KZE & ZP*KPE Compressor Line-up

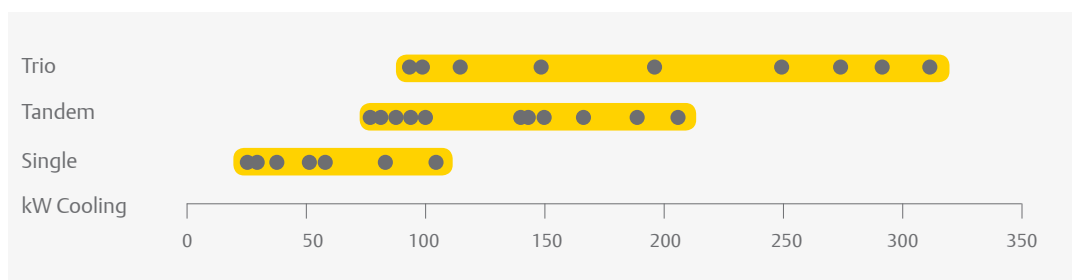

Multiple Copeland Scroll Nominal Cooling kW @(5/50) EN12900 - 1 Circuit

Features and Benefits

- High seasonal performance (SEER)
5% improved SEER versus previous generation
- Flexibility & reduced complexity
Wide range of even and uneven tandem and trio assemblies for a full system line-up with a reduced number of compressor models in stock.
- Enhanced reliability through electronics

The CoreSense Communications module provides realtime compressor data via RS485 Modbus that is used by the system controller to provide temperature protection. This ensures greater reliability for demanding applications.

Operating Envelope R410A

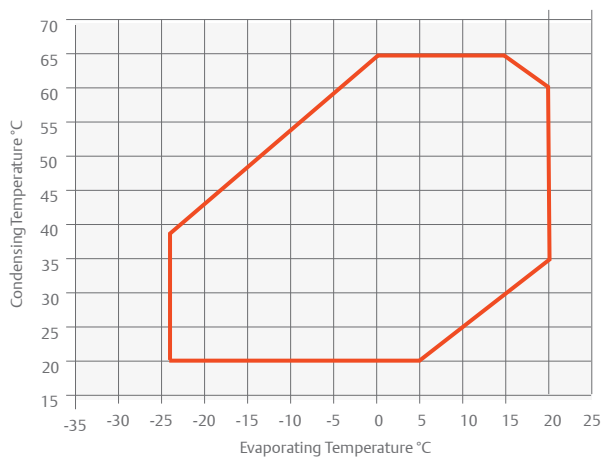

Technical Overview

Models	Nominal hp	Capacity (kW)	COP	Displacement (m ³ /h)	Stub Suction (inch)	Stub Discharge (inch)	Oil Quantity (l)	Length/Width/Height (mm)	Net Weight (kg)	Motor Version/Code		Maximum Operating Current (A)		Locked Rotor Current (A)		Sound Pressure @1 m - dB(A) ***
										1 Ph*	3 Ph**	1 Ph*	3 Ph**	1 Ph*	3 Ph**	
ZP137KPE	12.0	29.0	3.2	22.1	1 3/8	7/8	3.3	264/285/552	65		TFD		25.0		118	65
ZP154KPE	13.0	33.0	3.1	24.9	1 3/8	7/8	3.3	264/285/552	65		TFD		31.0		140	65
ZP182KPE	15.0	39.0	3.1	29.1	1 3/8	7/8	3.3	326/295/552	66		TFD		34.0		174	66
ZP232KZE	20.0	50.6	3.3	36.6	1 5/8	1 1/8	4.4	344/292/661	90		TED		38.8		241	72
ZP292KZE	25.0	63.4	3.3	45.7	1 5/8	1 1/8	4.4	344/292/661	90		TED		48.6		287	73
ZP385KPE	30.0	82.9	3.2	60.8	1 5/8	1 3/8	6.3	447/427/724	177		TWD		65.4		310	74
ZP485KPE	40.0	105.0	3.2	77.3	1 5/8	1 3/8	6.3	368/345/756	190		TWD		82.6		408	78

Conditions EN12900 : Evaporating 5°C, Condensing 50°C, Superheat 10K, Subcooling 0K

** 3 Ph: 380-420V/ 50Hz

*** @ 1m: sound pressure level at 1m distance from the compressor, free field condition

Preliminary Data

Capacity Data

Condensing Temperature +40°C															
R410A	Cooling Capacity (kW)							R410A	Power Input (kW)						
	Evaporating Temperature (°C)								Evaporating Temperature (°C)						
Model	-15	-10	-5	0	+5	+10	+15	Model	-15	-10	-5	0	+5	+10	+15
ZP137KPE	15.4	19.2	23.4	28.1	33.6	39.9	47.1	ZP137KPE	7.4	7.4	7.4	7.4	7.4	7.4	7.5
ZP154KPE	17.6	21.8	26.7	32.2	38.5	45.6	53.6	ZP154KPE	8.7	8.6	8.6	8.4	8.4	8.4	8.5
ZP182KPE	21.0	26.1	31.7	38.1	45.3	53.4	62.6	ZP182KPE	10.2	10.1	10.1	10.0	10.0	9.9	9.8
ZP232KZE	27.2	33.5	40.6	48.8	58.1	68.6	89.5	ZP232KZE	12.1	12.2	12.2	12.3	12.3	12.3	12.4
ZP292KZE	34.6	42.4	51.3	61.3	72.5	85.0	98.8	ZP292KZE	15.6	15.6	15.7	15.7	15.7	15.7	15.7
ZP385KPE	45.5	55.6	67.3	80.8	96.3	113.8	133.7	ZP385KPE	20.5	20.5	20.5	20.6	20.8	21.1	21.5
ZP485KPE	58.5	71.1	85.6	102.3	121.3	142.9	167.4	ZP485KPE	25.8	25.8	25.9	26.1	26.4	26.7	27.2

Condition: Suction Superheat 10K / Subcooling 0K

Preliminary Data

Tandem Model Overview

Model	Nominal hp	Cooling Capacity (kW)	Even Tandem	Uneven Tandem
Tandem ZPT - Tandem Uneven ZPU				
ZPT 274 K	2 x 12	58	•	
ZPT 308 K	2 x 13	67	•	
ZPU 336 K	13 + 15	72		•
ZPT 364 K	2 x 15	77	•	
ZPU 414 K	15 + 20	89		•
ZPT 464 K	2 x 20	101	•	
ZPU 474 K	15 + 25	102		•
ZPU 524 K	20 + 25	114		•
ZPT 584 K	2 x 25	125	•	
ZPU 677 K	25 + 30	146		•
ZPU 717 K	20 + 40	155		•
ZPT 770 K	2 x 30	165	•	
ZPU 870 K	30 + 40	187		•
ZPT 970 K	2 x 40	209	•	

Conditions EN 12900: Evaporating 5°C, Condensing 50°C, Superheat 10K, Subcooling 0K

* Tandem assemblies by system manufacturers. Emerson can provide full technical support.

ZPD & ZRD Copeland Scroll Digital™ Compressor Ranges for R410A and R407C

Stepless capacity modulation in air conditioning applications: flexible solution for R407C and R410A.

In many cooling and heating systems, the load and the operating conditions vary over a wide range thus requiring the use of capacity modulation. Digital Scroll assures stepless modulation down to 10% of the nominal capacity, enabling precise temperature control, superior comfort and energy saving.

Digital Scroll compressors are the preferred choice for process cooling, refrigeration racks, refrigeration units, VRF, rooftop and air handling unit systems.

ZPD & ZRD Copeland Scroll Digital Compressor



ZPD & ZRD Digital Scroll Compressor Line-up R410A

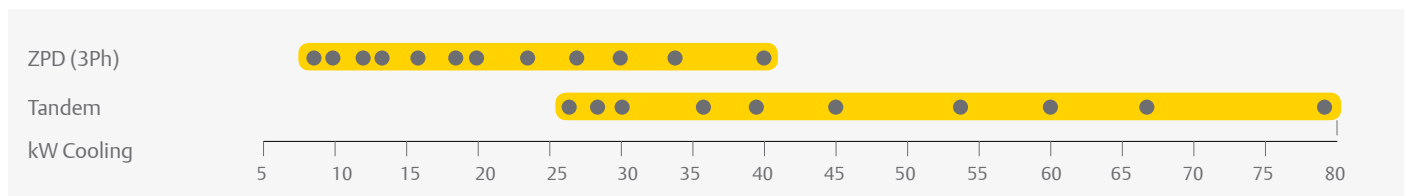

ZPD & ZRD Digital Scroll Compressor Line-up R407C

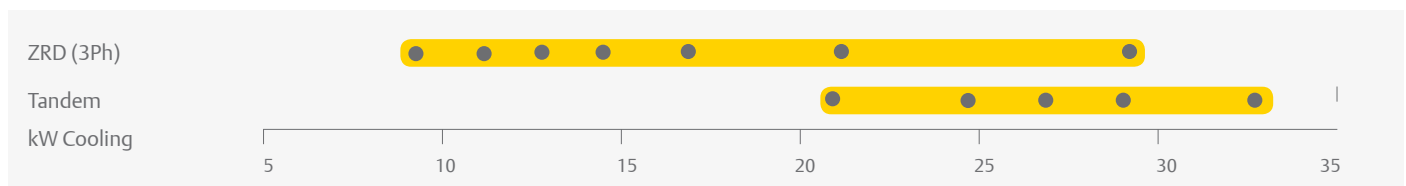

Conditions EN12900: Evaporating 5°C, Condensing 50°C, Superheat 10K, Subcooling 0K

Features and Benefits

- Wide modulation range from 10% to 100% for immediate load adjustment, close temperature comfort, optimal comfort
- No complex electronics, a quasi-drop-in solution for fast time to market, no EMI/EMC problems, easy installation and maintenance
- No impact on system mechanical balance: no vibration and resonance phenomenon, no frame / piping redesign necessary

Maximum Allowable Pressure (PS)

- Digital ZRD42 to ZRD81:
Low Side PS 20 bar(g) / High Side PS 29.5 bar(g)
- Digital ZRD94 to ZRD125:
Low Side PS 20 bar(g) / High Side PS 32 bar(g)
- Digital ZPD34 to ZPD91:
Low Side PS 28 bar(g) / High Side PS 43 bar(g)
- Digital ZPD103 to ZPD182:
Low Side PS 29.5 bar(g) / High Side PS 45 bar(g)

Operating Envelope R410A/R407C

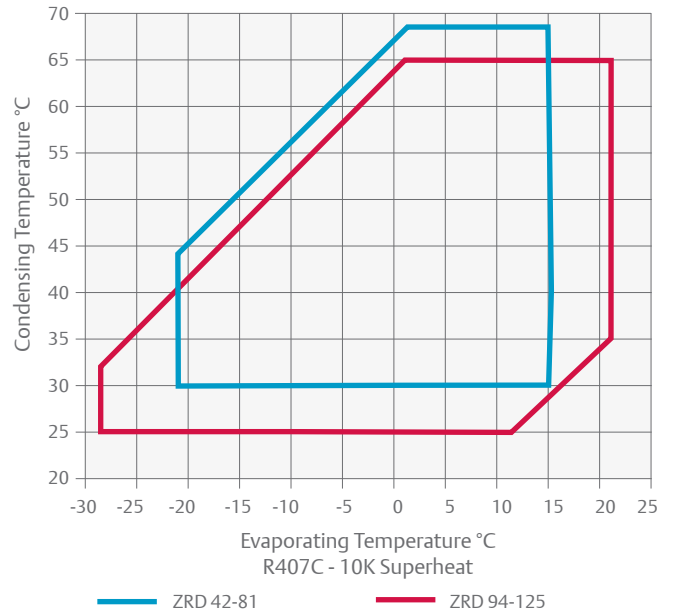
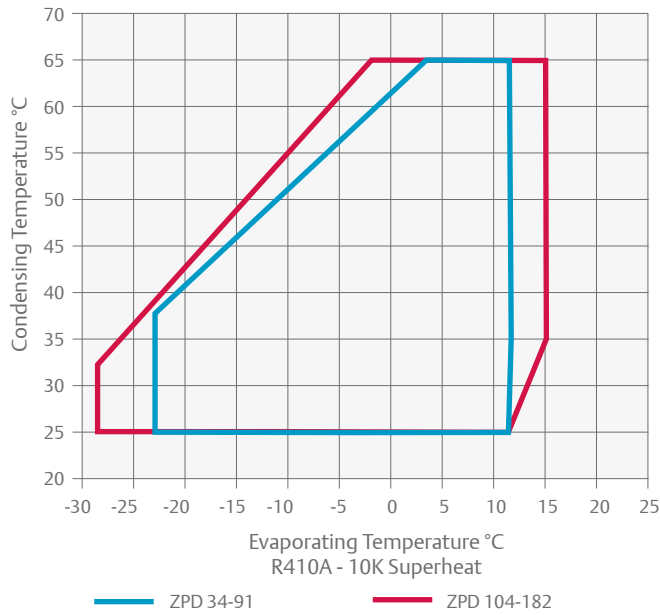

Technical Overview

Models	Nominal hp	Capacity (kW)	COP	Displacement (m ³ /h)	Stub Suction (inch)	Stub Discharge (inch)	Oil Quantity (l)	Length/Width/Height (mm)	Net Weight (kg)	Motor Version/Code	Maximum Operating Current (A)	Locked Rotor Current (A)	Sound Pressure @1 m - dB(A) **
										3 Ph*	3 Ph*	3 Ph*	
ZPD34KSE	3.0	7.3	2.8	5.7	7/8	1/2	1.24	243/243/448	31	TFM	12	64	66
ZPD42KSE	3.5	9.1	3.0	6.9	7/8	1/2	1.24	243/243/464	31	TFM	8	52	66
ZPD54KSE	4.5	11.5	3.0	8.9	7/8	1/2	1.24	236/236/479	35	TFM	10	62	67
ZPD61KCE	5.0	13.2	2.9	10.1	7/8	1/2	1.89	241/246/484	41	TFD	12	64	63
ZPD72KCE	5.0	15.2	2.9	11.6	7/8	1/2	1.89	241/246/484	40	TFD	15	75	67
ZPD83KCE	6.0	17.7	3.0	13.4	7/8	1/2	1.77	246/253/481	40	TFD	16	101	64
ZPD91KCE	7.5	19.2	3.1	14.7	7/8	3/4	1.80	246/253/481	40	TFD	16	101	69
ZPD104KCE	9.0	22.7	3.1	16.7	1 1/8	7/8	3.25	270/262/605	61	TFD	18	128	63
ZPD122KCE	10.0	26.3	3.1	19.7	1 1/8	7/8	3.25	270/262/605	62	TFD	21	139	63
ZPD137KCE	12.0	29.5	3.1	22.1	1 3/8	7/8	3.25	293/285/533	62	TFD	25	118	63
ZPD154KCE	13.0	33.1	3.1	24.8	1 3/8	7/8	3.25	314/285/552	65	TFD	27	140	66
ZPD182KCE	15.0	39.0	3.1	29.0	1 3/8	7/8	3.25	314/285/552	67	TFD	34	173	68

Conditions EN12900 R410A: Evaporating 5°C, Condensing 50°C, Superheat 10K, Subcooling 0K

* 3 Ph: 380-420V/ 50Hz

** @ 1m: sound pressure level at 1m distance from the compressor, free field condition

Models	Nominal hp	Capacity (kW)	COP	Displacement (m ³ /h)	Stub Suction (inch)	Stub Discharge (inch)	Oil Quantity (l)	Length/Width/Height (mm)	Net weight (kg)	Motor Version/Code	Maximum Operating Current (A)	Locked Rotor Current (A)	Sound Pressure @1 m - dB(A) **
										3 Ph*	3 Ph*	3 Ph*	
ZRD42KCE	3.5	8.9	2.9	9.9	3/4	1/2	1.24	241/241/462	31	TFD	7	46	60
ZRD48KCE	4.0	10.5	3.0	11.4	7/8	1/2	1.36	241/241/465	32	TFD	10	48	64
ZRD61KCE	5.0	12.5	3.0	14.3	7/8	1/2	1.89	241/246/481	38	TFD	9.6	64	65
ZRD72KCE	6.0	14.3	2.9	17.0	7/8	3/4	1.89	241/246/481	40	TFD	13	74	63
ZRD81KCE	6.0	17.0	3.1	18.7	7/8	3/4	1.89	241/246/481	41	TFD	15	100	67
ZRD94KCE	7.5	21.0	3.3	22.1	1 1/8	7/8	2.51	293/285/476	58	TFD	16	95	64
ZRD125KCE	10.0	27.7	3.3	28.8	1 3/8	7/8	3.25	293/285/533	61	TFD	20	118	64

Conditions EN12900 R410A: Evaporating 5°C, Condensing 50°C, Superheat 10K, Subcooling 0K

* 3 Ph: 380-420V/50Hz

** @1m: sound pressure level at 1m distance from the compressor, free field condition

Capacity Data

Condensing Temperature +40°C															
R410A	Cooling Capacity (kW)							R410A	Power Input (kW)						
	Evaporating Temperature (°C)								Evaporating Temperature (°C)						
Model	-15	-10	-5	0	+5	+10	+15	Model	-15	-10	-5	0	+5	+10	+15
ZPD34KSE	3.9	5.0	6.2	7.6	9.2	11.0		ZPD34KSE	2.1	2.1	2.1	2.0	2.0	2.0	
ZPD42KSE	4.8	5.9	7.3	8.8	10.6	12.6		ZPD42KSE	2.3	2.3	2.4	2.4	2.4	2.3	
ZPD54KSE	6.5	7.9	9.5	11.4	13.5	16.0		ZPD54KSE	3.1	3.1	3.1	3.0	3.0	3.0	
ZPD61KCE	6.9	8.6	10.5	12.7	15.3	18.2		ZPD61KCE	3.3	3.4	3.5	3.5	3.6	3.6	
ZPD72KCE	8.2	10.1	12.3	14.8	17.6	20.9		ZPD72KCE	3.9	4.0	4.1	4.1	4.2	4.2	
ZPD83KCE	9.7	11.9	14.4	17.2	20.5	24.1		ZPD83KCE	4.5	4.6	4.7	4.7	4.8	4.9	
ZPD91KCE	10.1	12.6	15.3	18.5	22.1	26.2	30.9	ZPD91KCE	4.9	5.0	5.0	5.0	5.1	5.0	5.0
ZPD104KCE	12.3	15.1	18.3	21.9	26.1	30.8	36.2	ZPD104KCE	5.6	5.7	5.7	5.9	6.0	6.1	6.2
ZPD122KCE	14.2	17.5	21.2	25.4	30.3	35.8	42.0	ZPD122KCE	6.4	6.5	6.6	6.7	6.8	6.9	7.0
ZPD137KCE	15.5	19.4	23.7	28.7	34.2	40.3	47.2	ZPD137KCE	7.5	7.5	7.5	7.4	7.4	7.5	7.6
ZPD154KCE	17.8	22.0	26.6	31.9	38.0	45.0	53.0	ZPD154KCE	8.2	8.3	8.4	8.5	8.6	8.7	8.9
ZPD182KCE	22.3	26.8	32.0	37.9	44.6	52.5	61.6	ZPD182KCE	9.8	9.9	10.0	10.1	10.2	10.4	10.5

Conditions: Suction Superheat 10K / Subcooling 0K

Condensing Temperature +40°C															
R407C	Cooling Capacity (kW)							R407C	Power Input (kW)						
	Evaporating Temperature (°C)								Evaporating Temperature (°C)						
Model	-15	-10	-5	0	+5	+10	+15	Model	-15	-10	-5	0	+5	+10	+15
ZRD42KCE	4.3	5.4	6.7	8.3	10.1	12.2	14.6	ZRD42KCE	2.0	2.1	2.1	2.2	2.2	2.3	2.3
ZRD48KCE	4.9	6.4	8.0	10.0	12.3	15.0	18.1	ZRD48KCE	2.5	2.6	2.6	2.7	2.7	2.8	2.9
ZRD61KCE	6.1	7.7	9.5	11.7	14.2	17.3	21.0	ZRD61KCE	3.0	3.1	3.2	3.4	3.4	3.4	3.3
ZRD72KCE	3.5	6.0	8.9	12.3	16.2	20.6	25.6	ZRD72KCE	3.5	3.6	3.7	3.8	4.0	4.1	4.3
ZRD81KCE	8.0	10.2	12.8	15.8	19.2	23.2	27.7	ZRD81KCE	4.3	4.4	4.4	4.5	4.6	4.7	4.8
ZRD94KCE	10.0	12.7	16.0	19.8	24.1	28.9	34.5	ZRD94KCE	5.0	5.1	5.1	5.1	5.1	5.2	5.3
ZRD125KCE	13.2	16.9	21.3	26.3	31.7	37.6	43.7	ZRD125KCE	6.5	6.6	6.6	6.7	6.8	6.9	7.1

Conditions: Suction Superheat 10K / Subcooling 0K



XPV & ZPV Copeland Scroll™ Variable Speed Compressor Ranges for R410A With Inverter Drive

Copeland Scroll™ XPV and ZPV Variable Speed compressors are designed to deliver maximum cooling and heating efficiency when you need it most. Equipped with the latest variable speed technology, they allow system manufacturers and building owners to achieve superior performance when designing reversible chillers, heat pumps, precision cooling systems or rooftops.

In addition to Copeland market-proven robustness, the new XPV and ZPV ranges with their qualified inverter drive meet and exceed the level of reliability expected for these applications.

Copeland Scroll™
ZPV066
variable speed
compressor and
drive



XPV and ZPV Variable Speed Scroll Compressor Line-up

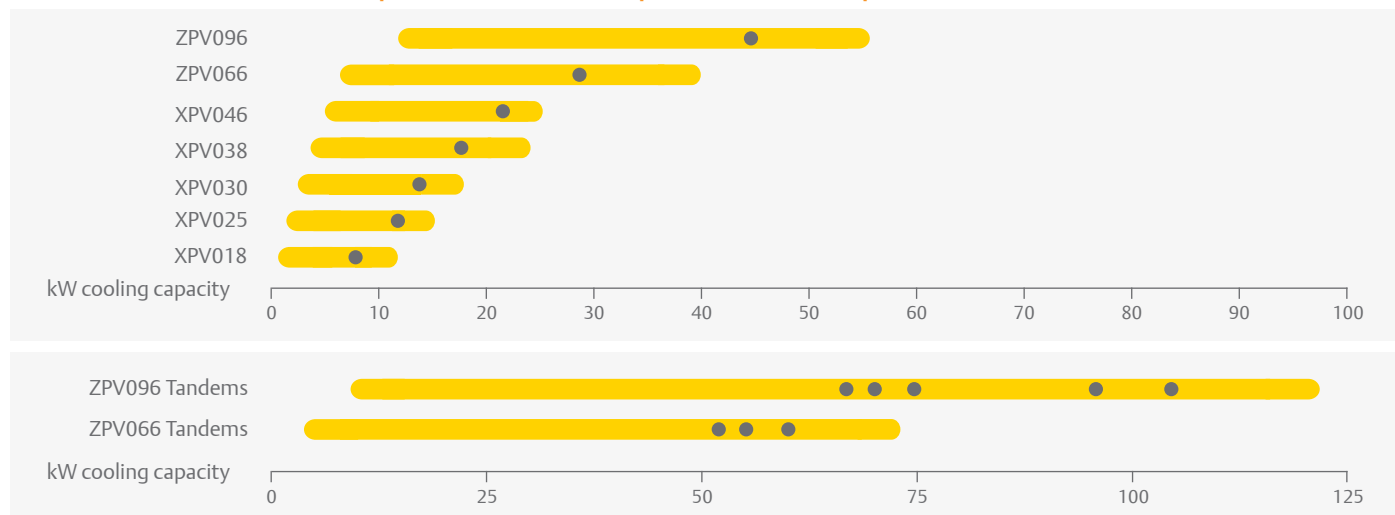

Features and Benefits

- Highest part load efficiency in its class enabling significant energy savings and standards compliance
- Wide speed range for enhanced part load efficiency and dehumidification: 900 - 7,200 RPM (15-120Hz)
- Capability to be tandemized with fixed speed compressors for maximum flexibility in system design
- Both compressor and drive are Copeland™ approved for reduced design time, cost and speed to market
- BPM motor technology for highest efficiency
- Sound reduction technology for reversible chiller transition and defrost

Maximum Allowable Pressure (PS)

- XPV018-046
Low Side PS 29.5 bar(g) / High Side PS 45 bar(g)
- ZPV066 - 096
Low Side PS 29.5 bar(g) / High Side PS 45 bar(g)

ZPV Operating Envelope R410A

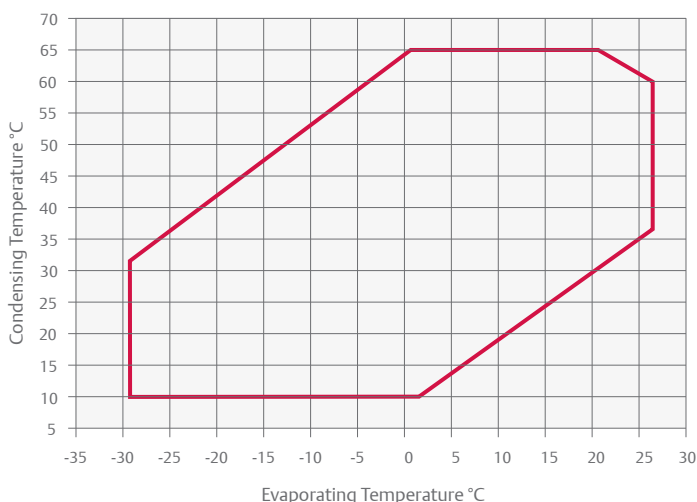

XPV Operating Envelope R410A

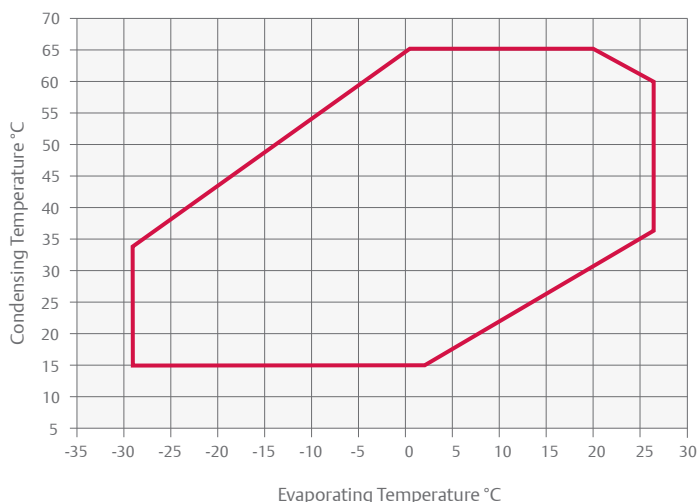

Technical Overview

Compressor										
R410A	Cooling Capacity (kW)		EER*	Displacement (cm ³)	Stub Suction (inch)	Stub Discharge (inch)	Oil Quantity (l)	Length/Width/Height (mm)	Net weight (kg)	Sound Pressure @1 m - dB(A) **
	Min	Max								
XPV0182E	2.0	10.4	3.1	18.0	3/4	1/2	0.7	194/216/335	16	n.a.
XPV0252E	2.7	14.5	3.1	25.0	3/4	1/2	0.7	194/216/335	16	n.a.
XPV0302E	3.3	17.4	3.1	30.0	3/4	1/2	0.7	194/216/335	18	n.a.
XPV0382E	4.3	22.5	3.2	38.0	3/4	1/2	1.2	194/216/335	21	n.a.
XPV0462E	6.4	24.0	3.2	46.0	3/4	1/2	1.2	219/198/388	22	n.a.
ZPV0662E	8.3	39.0	3.0	63.0	1 1/8	7/8	2.5	273/262/559	40	73
ZPV0962E	12.9	53.3	3.1	96.0	1 1/8	7/8	2.5	273/262/559	44	75

Conditions EN12900: Evaporating 5°C, Condensing 50°C, Superheat 10K, Subcooling 0K
*@ Nominal speed (90hz)

** @ 1m: sound pressure level at 1m distance from the compressor, free field condition

Preliminary Data

Inverter Drive														
Model	Matched Compressor **	Capacity (kW)		Amps (A)	Cooling	Frequency (Hz)		Net Weight (kg)	1ph 230V	3Ph 400V	3Ph 230V	3Ph 575V	Comm.	Depth/Width/Height (mm) *
		Nominal	Nominal			Min	Max							
ED3015A	XPV018	3.8	15	Horizontal / Flatplate	15	120	3.6	√					Modbus RTU and Analog board for 0-10V	205/240/143.5
ED3020A	XPV025	5.0	20		15	120		√						180.5/205/255
ED3018B	XPV025 / XPV030	5.0	18		15	120			√					180.5/205/255
ED3022B	XPV038 / XPV046	8.0	22	Fan / Horizontal / Vertical / Flatplate	15	120			√				154/233/316	
EVC1150	ZPV066	15.0		Fan Cooled	17	120	7.4		√	√	√		202/143/391	
EVC1185	ZPV096	18.5			20	120	14.0		√	√	√		227/210/391	

Conditions: Suction Superheat 5K, Subcooling 4K

*Standard voltage air-cooled version including fins

** Matching with XPV Ongoing

Capacity Data

Condensing Temperature +50°C															
R410A		Cooling Capacity (kW)							R410A		Power Input (kW)				
		Evaporating Temperature (°C)									Evaporating Temperature (°C)				
Model		-15	-10	-5	0	+5	+10	+15	Model		-15	-10	+5	+10	+15
XPV0182E	Max	5.8	7.0	8.4	10.1	12.0	14.1	16.5	XPV0182E	Max	3.6	3.7	3.7	3.7	3.7
	Min	1.5	1.6	1.7	1.7	2.0	2.4	2.9		Min	1.0	1.0	0.8	0.8	0.8
XPV0252E	Max	7.2	8.8	10.8	13.2	15.8	18.8	22.2	XPV0252E	Max	4.8	4.9	5.2	5.2	5.2
	Min	2.2	2.4	2.4	2.4	2.9	3.4	4.1		Min	1.4	1.4	1.1	1.1	1.0
XPV0302E	Max	8.9	10.7	12.9	15.6	18.8	22.5	26.7	XPV0302E	Max	5.5	5.6	5.9	6.0	6.0
	Min	2.2	2.5	1.5	1.9	2.3	2.7	3.7		Min	1.8	1.6	1.0	1.0	1.0
XPV0382E	Max	11.3	13.6	16.4	19.8	23.8	28.5	33.8	XPV0382E	Max	7.0	7.1	7.5	7.5	7.6
	Min	2.8	3.2	1.9	2.4	2.9	3.4	4.6		Min	2.2	2.0	1.2	1.2	1.3
XPV0462E	Max	13.6	16.4	19.8	23.9	28.8	34.4	40.8	XPV0462E	Max	8.1	8.3	8.7	8.7	8.7
	Min	3.6	4.5	2.2	2.8	3.3	4.0	5.1		Min	2.7	2.6	1.4	1.4	1.4
ZPV0662E	Max	19.1	23.3	28.2	34.0	40.6	48.2	56.8	ZPV0662E	Max	13.2	13.5	14.3	14.5	14.7
	Min	6.2	4.9	6.0	7.1	8.3	9.8	11.5		Min	4.2	3.0	2.9	2.8	2.8
ZPV0962E	Max	28.0	34.3	41.7	50.4	60.4	71.8	84.6	ZPV0962E	Max	18.2	18.7	20.0	20.4	20.8
	Min	9.1	7.5	9.0	10.8	12.8	15.2	18.0		Min	5.7	4.1	4.1	4.1	4.0

Condition: Suction Superheat 5K, Subcooling 4K

Preliminary Data

ZH Copeland Scroll™ Fixed Speed Compressor Range for R410A and R407C

ZH Copeland Scroll Compressor Range

The ZH compressor range is optimized for reversible and heat pump applications. In addition to the existing R407C range, a complete new range optimized for R410A has been developed. Both ranges are based on three platform sizes and cover a capacity of 4kW to 38kW.

ZH heating compressors have been optimized for reversible heating systems, they deliver higher capacity and efficiency at low evaporating (heat source) temperatures and are therefore better adapted to heating requirements than standard air conditioning compressors. Due to their larger operating map they also require less additional heating (electrical or gas) to cover the full heating demand on the coldest days and therefore further improve the system seasonal efficiency.

ZH Scroll Compressors With Enhanced Vapor Injection

ZH heating compressors with Enhanced Vapor Injection have been further optimized to ensure best-in-class performances in dedicated heating applications. This technology allows replacement of traditional boilers in new building and retrofit applications, without the need of substituting existing heating elements in the building.

ZH Copeland Scroll heating compressors with Enhanced Vapor Injection have an additional port to inject vapor within the compression process. This improves system performances by increasing the heating capacity for a given compressor displacement. Additional benefits are the reduction of the gas



ZH Scroll Compressor

discharge temperature and the extension of the operating envelope which enable the production of high temperature water at all working conditions.

ZHI heating compressors reach the same high standards of durability and reliability as other Copeland Scroll compressors. This includes the ability to handle relatively large amounts of liquid, which is known to damage or cause compressor failures. Fewer moving parts, robust running gear and low vibration due to balanced compression mechanism make the ZH range of Copeland Scroll compressors the most reliable solution available in the heat pump market.

ZH Nomenclature Guidelines

ZH**K4E

Qualified for R407C/R134a
without enhanced vapor injection - ** capacity in Btu/h

ZH**KVE

Qualified for R407C only
enhanced vapor injection - ** capacity in kW

ZH**K1P

Qualified for R410A only
without enhanced vapor injection - ** capacity in kW

ZHI**K1P

Qualified for R410A only
enhanced vapor injection - ** capacity in kW

Enhanced Vapor Injection: System Design

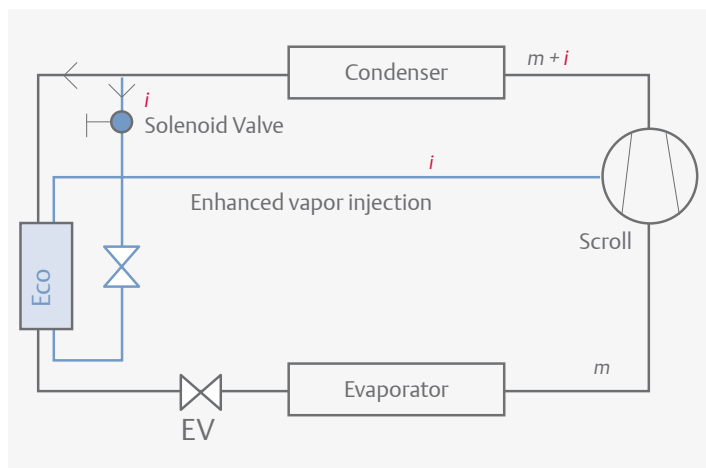

Enhanced Vapor Injection: Enthalpy Diagram

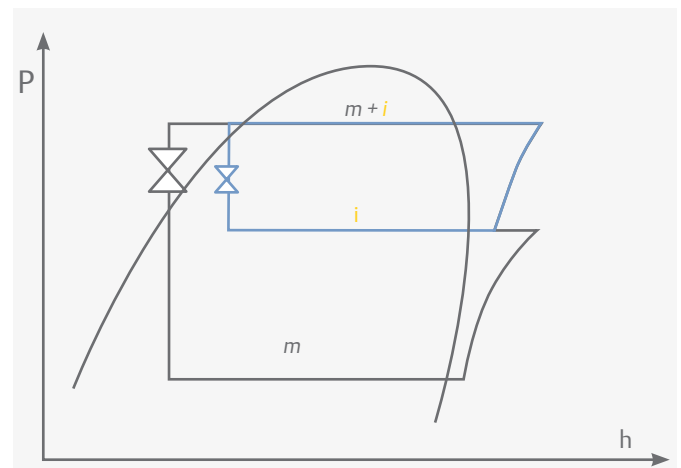

ZH* K4E / ZH* KVE Scroll Compressor Line-up R407C

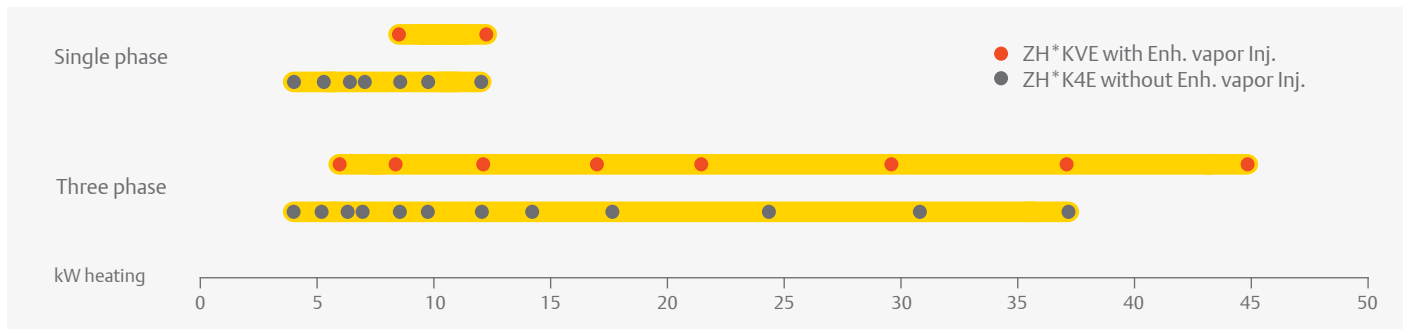

Conditions: Evaporating -7°C, Condensing 50°C, 4K Subcooling, 5K Superheat

ZH* P / ZHI* P Scroll Compressor Line-up R410A

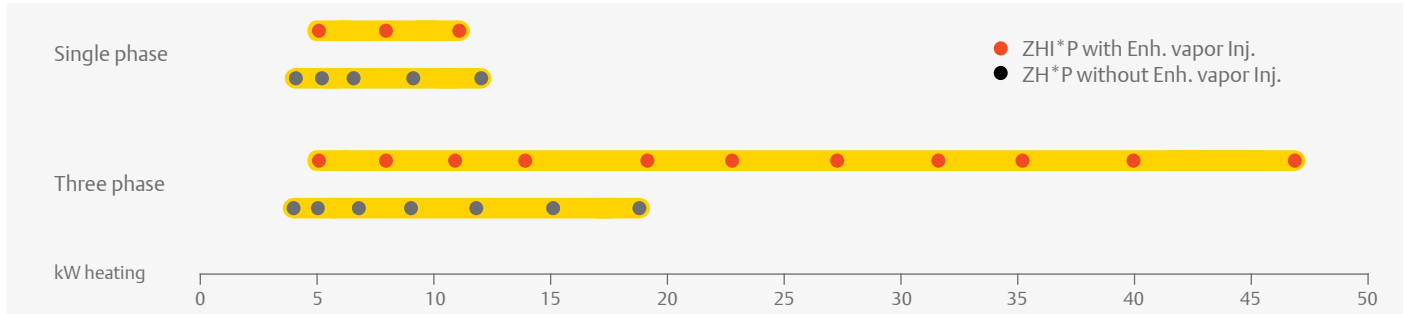

Conditions: Evaporating -7°C, Condensing 50°C, 4K Subcooling, 5K Superheat

Features and Benefits

- Copeland Scroll axial and radial compliance for high reliability
- High efficiency and increased heating capacity
- High water temperature for all applications
- Low sound and low vibration level
- Tandem combination for superior seasonal efficiency
- Enhanced Vapor Injection technology for best seasonal efficiency

Maximum Allowable Pressure (PS)

- ZH(I)04K1P to ZH(I)23K1P:
Low Side PS 28 bar(g) / High Side PS 45 bar(g)
- ZHI27K1P to ZHI46K1P:
Low Side PS 29.5 bar(g) / High Side PS 53 bar(g)
- ZH12K4E to ZH45K4E:
Low Side PS 20 bar(g) / High Side PS 32 bar(g)
- ZH56K4E to ZH11M4E:
Low Side PS 22.6 bar(g) / High Side PS 32 bar(g)
- ZH09KVE to ZH18KVE:
Low Side PS 20 bar(g) / High Side PS 32 bar(g)
- ZH24KVE to ZH48KVE:
Low Side PS 22.6 bar(g) / High Side PS 32 bar(g)

Operating Envelope R410A Heating

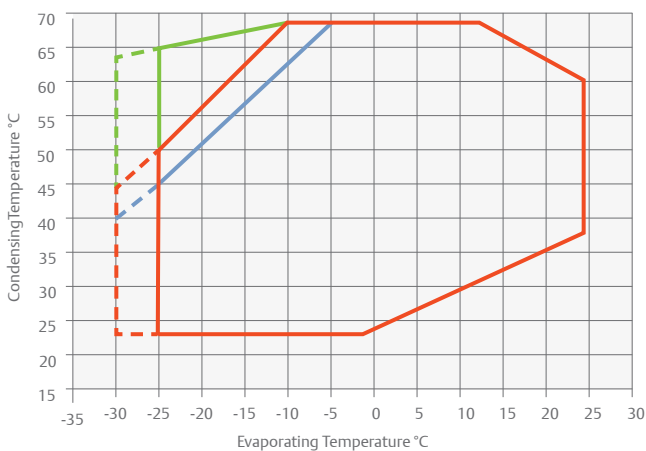

- ZH*P without Enh. Vapor Inj.
- - - ZH*P 2000 Hours Max.
- ZHI*P with Enh. Vapor Inj.
- - - ZHI*P 2000 Hours Max.
- Wet Injection

Operating Envelope R407C Heating

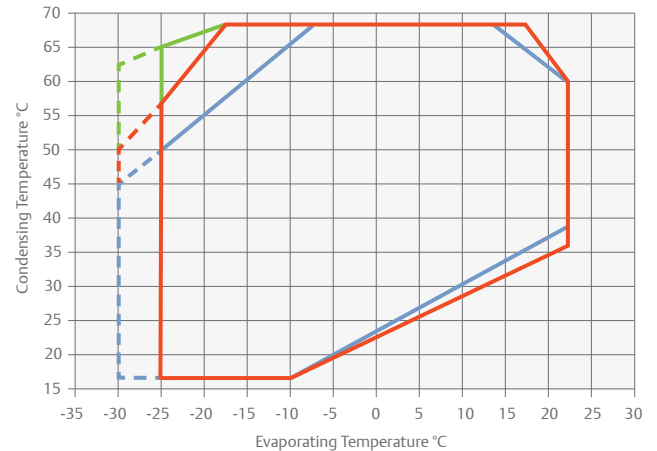

- ZH*P without Enh. vapor Inj.
- - - ZH*P 2000 hours max.
- ZHI*P with Enh. vapor Inj.
- - - ZHI*P 2000 hours max.
- Wet injection

Refer to Emerson's select selection software for individual model operating envelopes and other refrigerants.

Technical Overview

R410A	Nominal hp	Capacity (kW)	COP	Displacement (m ³ /h)	Stub Suction (inch)	Stub Discharge (inch)	Oil Quantity (l)	Length/Width/Height (mm)	Net Weight (kg)	Motor Version/Code		Maximum Operating Current (A)		Locked Rotor Current (A)		Sound Pressure @1 m - dB(A) ***
										1 Ph*	3 Ph**	1 Ph*	3 Ph**	1 Ph*	3 Ph**	
ZH04 K1P	1.8	4.2	2.8	3.4	3/4	1/2	0.7	229/198/388	22	PFZ	TFM	9	5	50	28	62
ZH05 K1P	2.0	5.0	2.8	4.0	3/4	1/2	0.7	229/198/388	22	PFZ	TFM	13	5	60	28	62
ZH06 K1P	2.7	6.6	2.9	5.1	7/8	1/2	1.2	242/242/418	31	PFZ	TFM	17	6	83	44	62
ZH09 K1P	3.5	9.0	3.1	6.9	7/8	1/2	1.2	242/242/418	33	PFZ	TFM	23	7	108	52	62
ZH12 K1P	4.5	11.4	3.0	8.9	7/8	1/2	1.2	242/242/418	35	PFZ	TFM	28	10	130	62	65
ZH15 K1P	5.0	15.1	3.1	11.7	7/8	1/2	1.9	245/249/442	39		TFM		13		75	67
ZH19 K1P	6.5	18.7	3.2	14.8	7/8	3/4	1.9	239/244/443	39		TFM		17			67
ZHI05 K1P	1.9	5.2	3.0	3.4	3/4	1/2	0.7	229/198/388	22	PFZ	TFM	14	4	60	28	63
ZHI08 K1P	2.8	8.2	3.1	5.1	7/8	1/2	1.2	242/242/418	31	PFZ	TFM	19	6	108	43	63
ZHI11 K1P	3.6	10.8	3.2	6.9	7/8	1/2	1.2	242/242/418	31	PFZ	TFM	25	9	130	52	65
ZHI14 K1P	4.6	13.9	3.3	8.9	7/8	1/2	1.2	242/242/418	34		TFM		11		70	65
ZHI18 K1P	5.0	17.9	3.4	11.7	7/8	1/2	1.9	249/245/443	41		TFM		15			67
ZHI23 K1P	6.5	22.8	3.4	14.8	7/8	3/4	1.9	239/244/443	41		TFM		19			67
ZHI27 K1P	9.0	27.0	3.3	16.8	1 3/8	7/8	3.3	280/280/533	63		TFD		21.0		118	77
ZHI32 K1P	10.0	31.7	3.2	19.8	1 3/8	7/8	3.3	280/280/533	63		TFD		26.0		140	75
ZHI35 K1P	12.0	35.6	3.2	22.1	1 3/8	7/8	3.3	280/284/568	63		TFD		32.5		174	76
ZHI40 K1P	13.0	39.7	3.3	24.9	1 3/8	7/8	3.3	284/280/568	64		TFD		33.0		174	76
ZHI46 K1P	15.0	46.6	3.3	29.1	1 3/8	7/8	3.4	284/280/568	64		TWD		37.4		168	78

Conditions: Evaporating -7°C, Condensing 50°C, Superheat 5K, Subcooling 4K

* 1 Ph: 230V/ 50Hz

** 3 Ph: 380-420V/ 50Hz

*** @ 1m: sound pressure level at 1m distance from the compressor, free field condition

R407C	Nominal hp	Capacity (kW)	COP	Displacement (m ³ /h)	Stub Suction (inch)	Stub Discharge (inch)	Oil Quantity (l)	Length/Width/Height (mm)	Net Weight (kg)	Motor Version/Code		Maximum Operating Current (A)		Locked Rotor Current (A)		Sound Pressure @1 m - dB(A) ***
										1 Ph*	3 Ph**	1 Ph*	3 Ph**	1 Ph*	3 Ph**	
ZH12K4E	1.7	3.7	3.0	4.7	3/4	1/2	0.7	229/198/388	21	PFZ		10		44		53
ZH15K4E	2.0	4.6	3	5.8	3/4	1/2	1.3	243/242/364	23	PFJ	TFD	11.6	4.3	61	26	60
ZH21K4E	3.0	6.5	3.1	8.0	3/4	1/2	1.5	243/242/387	27	PFJ	TFD	16	5	76	32	59
ZH26K4E	3.5	8.2	3.1	10.0	3/4	1/2	3.1	243/242/400	28	PFJ	TFD	20	7	97	46	63
ZH30K4E	4.0	9.5	3.1	11.7	7/8	1/2	1.9	247/241/438	38	PFJ	TFD	25	8	108	52	62
ZH38K4E	5.0	11.7	3.2	14.4	7/8	1/2	1.9	247/241/438	38	PFZ	TFD	31	10	150	64	63
ZH45K4E	6.0	14.0	3.2	17.1	7/8	1/2	1.9	250/246/438	36		TFD		12		74	64
ZH56K4E	7.5	17.4	3.1	20.9	1 3/8	7/8	4.0	357/321/497	93		TWD		17		99	69
ZH75K4E	10.0	24.2	3.2	28.8	1 3/8	7/8	4.0	357/321/497	93		TWD		21		127	70
ZH92K4E	13.0	30.7	3.3	35.6	1 3/8	7/8	4.1	356/320/505	95		TWD		25		167	72
ZH11M4E	15.0	37.0	3.3	42.8	1 5/8	7/8	4.1	357/321/579	112		TWD		32		198	72
ZH06KVE	2.5	6.2	3.3	5.8	3/4	1/2	1.3	243/243/364	27.5		TFM		4.4		26	62
ZH09KVE	3.0	8.2	3.3	8.0	3/4	1/2	1.5	243/243/386	30	PFZ	TFD	21	7	97	40	62
ZH13KVE	4.0	11.8	3.4	11.7	7/8	1/2	1.9	244/241/438	38	PFZ	TFD	30	10	160	64	65
ZH18KVE	6.0	16.7	3.4	17.1	7/8	1/2	1.9	244/241/438	41		TFD		14		101	67
ZH24KVE	7.5	21.3	3.3	20.9	1 3/8	7/8	4.0	368/321/525	93		TWD		18		99	73
ZH33KVE	10.0	29.5	3.4	29.0	1 3/8	7/8	4.0	368/321/525	93		TWD		24		127	73
ZH40KVE	13.0	37.0	3.4	35.5	1 3/8	7/8	4.1	368/321/532	103		TWD		30		167	73
ZH48KVE	15.0	44.7	3.4	42.8	1 5/8	7/8	4.1	368/323/579	112		TWD		36		198	76

Conditions: Evaporating -7°C, Condensing 50°C, Superheat 5K, Subcooling 4K

* 1 Ph: 230V/ 50Hz

** 3 Ph: 380-420V/ 50Hz

*** @ 1m: sound pressure level at 1m distance from the compressor, free field condition

Capacity Data

Condensing Temperature +50°C															
R410A	Heating Capacity (kW)							R410A	Power Input (kW)						
	Evaporating Temperature (°C)								Evaporating Temperature (°C)						
Model	-30	-15	-10	-5	0	+5	+15	Model	-30	-15	-10	-5	0	+5	+15
ZH04 K1P	n.a.	3.3	3.9	4.5	5.2	6.0	7.6	ZH04 K1P	n.a.	1.4	1.5	1.5	1.5	1.5	1.5
ZH09 K1P	n.a.	7.1	8.2	9.5	10.9	12.5	16.4	ZH09 K1P	n.a.	2.8	2.9	3.0	3.0	3.0	3.0
ZH12 K1P	n.a.	9.2	10.5	12.1	13.9	15.9	21.0	ZH12 K1P	n.a.	3.7	3.7	3.8	3.8	3.8	3.8
ZH15 K1P	n.a.	12.0	13.8	15.9	18.4	21.1	27.7	ZH15 K1P	n.a.	4.7	4.9	5.0	5.1	5.2	5.2
ZH19 K1P	n.a.	15.2	17.5	20.2	23.2	26.7	35.1	ZH19 K1P	n.a.	6.0	6.2	6.3	6.4	6.5	6.5

Models With Enhanced Vapor Injection															
Model	-30	-15	-10	-5	0	+5	+15	Model	-30	-15	-10	-5	0	+5	+15
ZHI05 K1P	2.6	4.2	4.8	5.4	6.1	6.9	8.6	ZHI05 K1P	1.7	1.7	1.7	1.8	1.8	1.8	1.7
ZHI08 K1P	5.0	6.7	7.6	8.4	9.4	10.5	13.1	ZHI08 K1P	2.5	2.6	2.6	2.6	2.6	2.6	2.4
ZHI11 K1P	6.4	9.0	10.1	11.3	12.6	14.0	17.2	ZHI11 K1P	3.2	3.3	3.3	3.3	3.3	3.3	3.1
ZHI14 K1P	8.5	11.6	13.0	14.5	16.2	18.1	22.3	ZHI14 K1P	3.9	4.1	4.2	4.2	4.2	4.2	4.0
ZHI18 K1P	10.8	14.9	16.7	18.7	20.9	23.2	28.7	ZHI18 K1P	5.1	5.3	5.4	5.4	5.4	5.3	5.2
ZHI23 K1P	13.8	19.0	21.3	23.9	26.6	29.7	36.7	ZHI23 K1P	6.6	6.8	6.9	6.9	6.9	6.8	6.6
ZHI27 K1P	14.2	22.1	25.1	28.4	31.8	35.5	43.8	ZHI27 K1P	7.9	8.2	8.2	8.1	8.1	7.9	7.5
ZHI32 K1P	16.4	26.1	29.5	33.2	37.1	41.4	51.1	ZHI32 K1P	8.7	9.7	9.8	9.8	9.7	9.6	9.4
ZHI35 K1P	19.5	29.2	33.1	37.3	41.9	46.7	57.4	ZHI35 K1P	11.0	10.8	10.9	11.0	11.1	11.2	11.1
ZHI40 K1P	21.7	32.5	36.9	41.7	47.0	52.7	65.6	ZHI40 K1P	12.0	12.0	12.1	12.1	12.2	12.2	12.3
ZHI46 K1P	26.1	38.7	43.5	48.7	54.3	60.4	74.0	ZHI46 K1P	13.2	14.0	14.1	14.1	14.1	14.1	14.0

Conditions: Suction Superheat 5K / Subcooling 4K

Condensing Temperature +50°C															
R407C	Heating Capacity (kW)							R407C	Power Input (kW)						
	Evaporating Temperature (°C)								Evaporating Temperature (°C)						
Model	-30	-15	-10	-5	0	+5	+15	Model	-30	-15	-10	-5	0	+5	+15
ZH12K4E	n.a.	2.8	3.3	3.9	4.6	5.4	7.5	ZH12K4E	n.a.	1.2	1.2	1.3	1.3	1.3	1.4
ZH15K4E	n.a.	3.6	4.3	5.0	5.8	6.8	9.2	ZH15K4E	n.a.	1.5	1.5	1.6	1.6	1.6	1.9
ZH21K4E	n.a.	5.1	5.9	6.9	8.1	9.6	13.2	ZH21K4E	n.a.	2.0	2.1	2.1	2.2	2.3	2.4
ZH26K4E	n.a.	6.3	7.4	8.7	10.3	12.1	16.5	ZH26K4E	n.a.	2.5	2.6	2.7	2.7	2.8	3.0
ZH30K4E	n.a.	7.3	8.6	10.1	11.9	14.0	19.2	ZH30K4E	n.a.	2.9	3.0	3.1	3.2	3.3	3.4
ZH38K4E	n.a.	9.0	10.6	12.5	14.6	17.2	23.4	ZH38K4E	n.a.	3.5	3.6	3.8	3.9	4.0	4.2
ZH45K4E	n.a.	10.8	12.7	14.9	17.4	20.3	27.2	ZH45K4E	n.a.	4.2	4.3	4.5	4.6	4.7	5.1
ZH56K4E	n.a.	13.4	15.8	18.6	21.8	25.5	34.1	ZH56K4E	n.a.	5.3	5.5	5.7	6.0	6.2	6.8
ZH75K4E	n.a.	18.5	21.9	25.8	30.3	35.5	47.6	ZH75K4E	n.a.	7.0	7.4	7.7	8.0	8.2	8.5
ZH92K4E	n.a.	23.4	27.8	32.8	38.5	45.1	60.3	ZH92K4E	n.a.	8.5	9.0	9.5	10.0	10.4	11.2
ZH11M4E	n.a.	28.4	33.6	39.5	46.3	54.3	72.7	ZH11M4E	n.a.	10.3	10.9	11.5	11.9	12.5	13.4

Models With Enhanced Vapor Injection															
Model	-30	-15	-10	-5	0	+5	+15	Model	-30	-15	-10	-5	0	+5	+15
ZH06KVE	3.3	4.9	5.7	6.5	7.4	8.4	10.8	ZH06KVE	1.7	1.8	1.9	1.9	2.0	2.0	2.1
ZH09KVE	4.1	6.6	7.6	8.7	9.9	11.2	14.3	ZH09KVE	2.1	2.4	2.4	2.5	2.6	2.6	2.6
ZH13KVE	5.7	9.5	10.9	12.5	14.3	16.2	20.7	ZH13KVE	3.0	3.4	3.5	3.5	3.6	3.6	3.7
ZH18KVE	8.0	13.5	15.4	17.6	20.0	22.6	28.7	ZH18KVE	4.2	4.8	4.9	5.0	5.1	5.1	5.2
ZH24KVE	9.7	17.0	19.6	22.5	25.5	28.9	36.7	ZH24KVE	5.2	6.2	6.4	6.6	6.7	6.8	7.0
ZH33KVE	14.3	23.7	27.2	31.1	35.3	40.0	50.7	ZH33KVE	7.0	8.2	8.5	8.8	9.1	9.3	9.6
ZH40KVE	18.1	29.6	34.1	39.1	44.7	50.9	65.5	ZH40KVE	8.9	10.2	10.6	11.0	11.3	11.7	12.4
ZH48KVE	21.1	35.6	41.1	47.2	54.1	61.8	80.4	ZH48KVE	10.0	12.2	12.7	13.2	13.5	14.0	15.1

Conditions: Suction Superheat 5K / Subcooling 4K

XHV & ZHW Copeland Scroll™ Variable Speed Compressor Ranges for R410A With Inverter Drive

XHV and ZHW Variable Speed scroll compressors for R410A, for outstanding performance for cooling and heating applications.

The new Emerson solution for variable speed applications with capacity modulated compressors. XHV and ZHW compressors deliver outstanding performances, both in new building and retrofit applications. Variable Speed Copeland Scroll compressors feature a state-of-the-art brushless permanent magnet motor matched with a highly efficient drive and vapor injection technology (ZHW only). In addition to Copeland market-proven robustness, XHV and ZHW compressors with the qualified inverter drive meet and exceed the level of reliability expected for these demanding applications.



ZHW Copeland Scroll Variable Speed Compressor and Drive

XHV & ZHW Variable Speed Scroll Compressor Line-Up

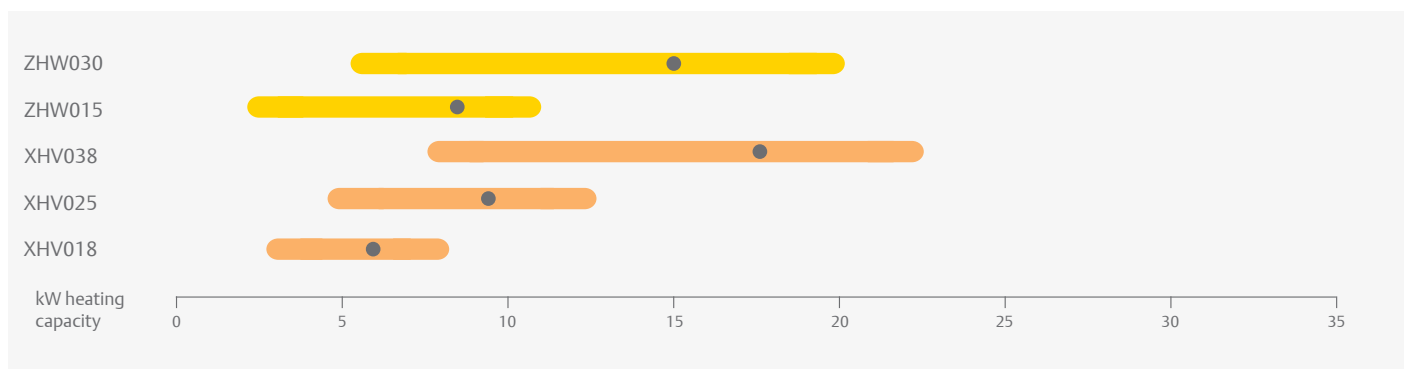

Conditions: Cooling kW evaporating 5°C, Condensing 50°C, superheat 10K, Subcooling 0K
 Heating kW evaporating -7°C, Condensing 50°C, 4K Subcooling, 5K Superheat

Features and Benefits

- Highest efficiency throughout the operating envelope and speed range
- Envelope and speed management information for the system controller (real-time communication via Modbus RS485)
- Enhanced Vapor Injection technology for best seasonal efficiency (ZHW)
- High water temperature for all applications
- Compliance with electromagnetic-compatibility (EMC) and electromagnetic-interference (EMI) requirements for residential applications
- VDE certification for ZHW compressor matched with Emerson inverter drive
- Wide speed range 15-120Hz
- Mutually optimized and qualified scroll and drive

Operating Envelope R410A

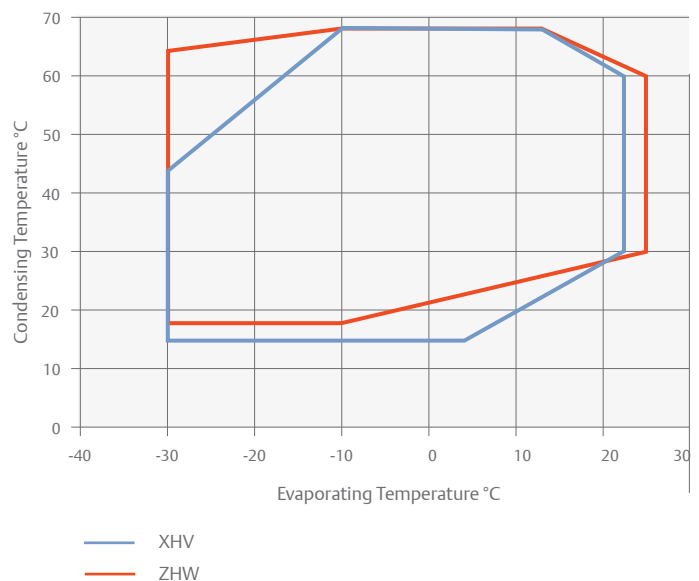

Maximum Allowable Pressure (PS)

- ZHW:
Low side PS 28 bar(g) / High side PS 45 bar(g)
- XHV:
Low side PS 28 bar(g) / High side PS 45 bar(g)

Technical Overview

Compressor										
R410A	Heating Capacity (kW)		COP*	Displacement (cm ³)	Stub Suction (inch)	Stub Discharge (inch)	Oil Quantity (l)	Length/Width/Height (mm)	Net Weight (kg)	Sound Pressure @1 m - dB(A)**
	Min	Max								
ZHW0152P	2.7	10.4	2.9	15.0	3/4	1/2	1.7	229/198/394	21	68
ZHW0302P	5.5	19.8	3.2	30.0	3/4	1/2	1.7	229/198/394	22	68
XHV0181P	2.9	8.2	2.9	18.0	3/4	1/2	0.7	218/198/334	14	n.a.
XHV0251P	3.9	12.4	2.9	25.0	3/4	1/2	0.7	218/198/334	15	n.a.
XHV0381P	5.5	22.9	3.1	38.0	3/4	1/2	1.2	218/198/414	21	n.a.

Conditions: Heating kW (-7/50)

*@ Nominal Speed (90Hz)

** @ 1m: sound pressure level at 1m distance from the compressor, free field condition

Preliminary Data

Inverter Drive											
Model	Matched Compressor	Power Input (kW)	Amps (A)	Cooling	Frequency (Hz)		Net Weight (kg)	1Ph 230V	3Ph 400V	Comm.	Length/Width/Height (mm)*
		Nominal	Nominal		Min	Max					
EV2033M	ZHW015	3.3		Air / Liquid	15	120	3.6	√	n.a.	Modbus	228/260/156
EV2037M	ZHW015	3.7			15	120	3.6	√	n.a.		228/260/119
EV2055M	ZHW015-30	5.5			15	120	3.6	√	√		
EV2080M	ZHW030	8.0			15	120	5.1	√	√		228/260/156
ED3011A	XHV018	2.6	11		15	120	2.8	√	n.a.		205/240/143.5
ED3015A	XHV018-25	3.8	15		15	120	3.6	√	n.a.		205/240/143.5
ED3020A	XHV025-38	5.0	20		15	120	3.6	√	n.a.		205/250/180.5
ED3013B	XHV018-25	3.8	13		15	120	3.6	n.a.	√		205/250/183.5
ED3018B	XHV025-38	5.0	18		15	120	3.6	n.a.	√		205/250/183.5
ED3022B	XHV038	8.0	22		15	120	5.1	n.a.	√		n.a.

Conditions: Suction Superheat 5K, Subcooling 4K

*Air Cooled Version Including Fins

Preliminary Data

Capacity Data

Condensing Temperature +50°C																	
R410A		Heating Capacity (kW)							R410A		Power Input (kW)						
		Evaporating Temperature (°C)									Evaporating Temperature (°C)						
Model		-30	-15	-10	-5	0	+5	+15	Model		-30	-15	-10	-5	0	+5	+15
ZHW0152P	Max	6.0	8.6	9.7	11.0	12.0	12.0	12.4	ZHW0152P	Max	3.1	3.3	3.3	3.4	3.2	2.9	2.4
	Min	2.0	2.6	2.8	2.9	3.1	3.1	3.8		Min	1.3	1.1	1.1	1.0	0.9	0.9	0.9
ZHW0302P	Max	11.3	16.3	18.5	20.8	22.6	22.6	23.7	ZHW0302P	Max	5.7	6.0	6.1	6.1	5.7	5.4	4.4
	Min	4.2	5.2	5.8	5.9	6.6	6.6	8.1		Min	2.4	2.0	2.0	1.9	1.7	1.7	1.7

Condition: Suction Superheat 10K, Subcooling 4K

Condensing Temperature +50°C																	
R410A		Heating Capacity (kW)							R410A		Power Input (kW)						
		Evaporating Temperature (°C)									Evaporating Temperature (°C)						
Model		-20	-15	-10	-5	0	+5	+15	Model		-20	-15	-10	-5	0	+5	+15
XHV0181P	Max	5.6	6.3	7.3	8.3	9.5	10.9	11.7	XHV0181P	Max	2.7	2.7	2.7	2.8	2.8	2.9	2.8
	Min	1.9	2.0	2.3	1.2	1.3	1.3	1.7		Min	1.2	1.1	0.9	0.5	0.4	0.4	0.5
XHV0251P	Max	9.3	10.5	12.0	13.8	15.8	18.1	19.6	XHV0251P	Max	4.3	4.4	4.4	4.5	4.6	4.6	4.6
	Min	3.0	3.3	3.8	1.9	2.1	2.2	2.9		Min	1.8	1.6	1.5	0.7	0.7	0.7	0.7
XHV0381P	Max	16.0	17.9	20.4	23.3	26.8	30.8	34.0	XHV0381P	Max	6.8	7.0	7.1	7.3	7.4	7.5	7.5
	Min	4.6	5.5	6.5	2.8	3.3	3.7	4.9		Min	2.5	2.4	2.4	1.1	1.1	1.1	1.1

Condition: Suction Superheat 5K, Subcooling 4K

Preliminary Data

ZH Copeland Scroll™ for Heat Recovery and High Condensing Applications for R134a

ZH*KCE R134a Copeland Scroll compressors were developed for the recovery and reuse of available heat. For example, the heat generated by processes or machining cooling equipment can be recovered and not wasted. This contributes to reducing the total energy cost of installations. On a water-cooled chiller, heat recovery on the condensing water loop can be used to produce high temperature water for sanitary or premise heating. With a typical evaporating temperature between 20°C and 40°C and condensing up to 85°C, ZH*KCE scrolls offer many opportunities of heat recovery.

The range of products goes from the ZH40KCE (7.5hp) to the ZH150 (30hp) which can be tandemized.



ZH*KCE Scroll Compressor for Heat Recovery

ZH*KCE Scroll Compressor Line-Up R134a

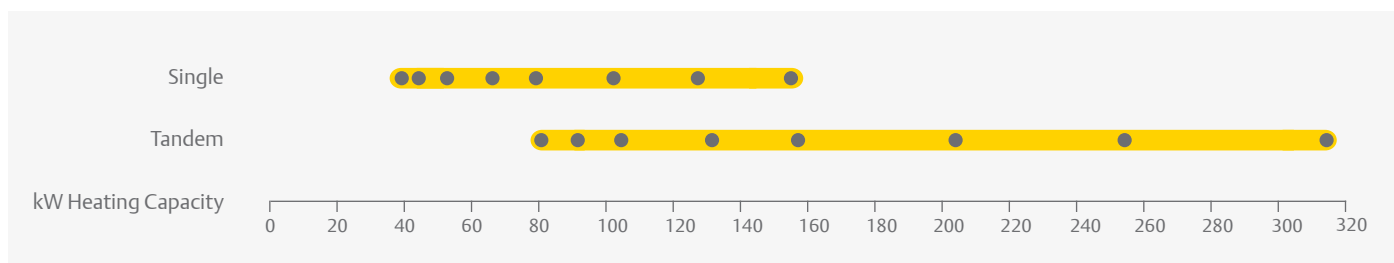

Conditions: Evaporating 40°C, Condensing 85°C, Superheat 10K, Subcooling 5K

Features and Benefits

- Copeland Scroll axial and radial compliance for superior reliability and efficiency
- Wide scroll line-up R134a with 8 models and tandem
- Low sound and vibration level
- Low oil circulation rate
- Copeland qualified tandem

Typical Applications

- Heat recovery on the dry cooler water circuit of a water-cooled chiller to produce sanitary water or other heating
- Re-inject energy to district heating network and avoid wasting it
- Process industry where the water returning from the machinery comes back between 20 and 40°C
- Food industry where one areas needs cooling and another heating at the same time
- Air-to-water heat pump, even during the warm season
- Exhaust air heat recovery system
- Heat recovery on Fluegas

Operating Envelope R134a

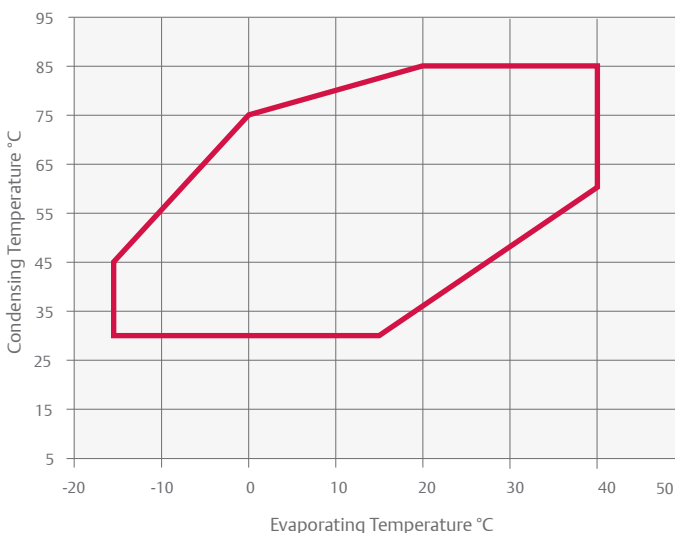

Maximum Allowable Pressure (PS)

Low side PS 20 bar(g) / High side PS 32 bar(g)

Technical Overview

Models	Nominal hp	Heating Capacity (kW)	COP	Displacement (m ³ /h)	Stub Suction (inch)	Stub Discharge (inch)	Oil Quantity (l)	Length/Width/Height (mm)	Net Weight (kg)	Motor Version / Code	Maximum Operating Current (A)	Locked Rotor Current (A)	Sound Pressure @1 m - dB(A) **
										3 Ph*	3 Ph*	3 Ph*	
ZH40KCE	7.5	39.0	4.3	22.1	1 ¹ / ₈	7/8	2.7	264 / 285 / 476	57	TFD	19.2	95	63
ZH45KCE	9.0	44.0	4.6	24.9	1 ³ / ₈	7/8	3.4	264 / 285 / 533	60	TFD	21.1	111	63
ZH50KCE	10.0	50.9	4.5	29.1	1 ³ / ₈	7/8	3.4	264 / 285 / 533	61	TFD	23.6	118	63
ZH64KCE	13.0	63.7	4.3	36.4	1 ³ / ₈	7/8	3.4	264 / 285 / 552	65	TFD	27.1	140	68
ZH75KCE	15.0	76.0	4.2	43.4	1 ³ / ₈	7/8	3.4	264 / 285 / 552	66	TFD	35.3	174	71
ZH100KCE	20.0	96.1	4.0	56.6	1 ⁵ / ₈	1 ³ / ₈	4.7	432 / 376 / 694	140	TWD	42.7	225	72
ZH125KCE	25.0	120.0	4.1	71.4	1 ⁵ / ₈	1 ³ / ₈	6.8	447 / 392 / 717	160	TWD	53.4	272	74
ZH150KCE	30.0	148.8	4.2	87.5	1 ⁵ / ₈	1 ³ / ₈	6.3	447 / 427 / 717	177	TWD	67.6	310	76

Conditions Evaporating 40°C - Condensing 85°C - Superheat 5K - Subcooling 4K

* 3 Ph: 380-420V/ 50Hz

** @ 1m: sound pressure level at 1m distance from the compressor, free field condition

Capacity Data

Condensing Temperature +80°C															
R134a	Heating Capacity (kW)							R134a	Power Input (kW)						
	Evaporating Temperature (°C)								Evaporating Temperature (°C)						
Models	+10	+15	+20	+25	+30	+35	+40	Models	+10	+15	+20	+25	+30	+35	+40
ZH40KCE	16.9	19.7	22.9	26.5	30.7	35.6	41.1	ZH40KCE	8.3	8.3	8.2	8.1	8.1	8.1	8.1
ZH45KCE	20.2	23.2	26.5	30.5	35.0	40.3	46.5	ZH45KCE	8.7	8.7	8.7	8.7	8.7	8.7	8.7
ZH50KCE	23.1	26.6	30.6	35.2	40.5	46.7	53.8	ZH50KCE	10.2	10.2	10.2	10.2	10.2	10.2	10.2
ZH64KCE	28.7	33.1	38.1	43.9	50.7	58.4	67.3	ZH64KCE	13.5	13.5	13.4	13.4	13.5	13.5	13.6
ZH75KCE	34.8	39.9	45.8	52.6	60.5	69.7	80.3	ZH75KCE	16.2	16.2	16.2	16.2	16.3	16.4	16.7
ZH100KCE	46.4	52.6	59.9	68.3	77.9	88.9	101.5	ZH100KCE	21.1	21.3	21.4	21.5	21.5	21.5	21.6
ZH125KCE	57.6	65.4	74.4	84.8	96.9	111.0	127.0	ZH125KCE	27.6	26.6	26.6	26.5	26.4	26.3	26.3
ZH150KCE	71.0	80.7	91.9	105.0	120.0	137.0	157.0	ZH150KCE	30.7	31.2	31.5	31.8	32.0	32.3	32.5

Conditions: Suction Superheat 5K / Subcooling 4K

ZRH & ZRHV Copeland Scroll™ Horizontal Compressor Ranges for R407C and R134a, for the specific needs of transport air conditioning

Air conditioning for passenger comfort is a pre-requisite in today's public transport vehicles. At the same time, maximization of passenger space and streamlining of high speed trains increasingly impose limitations on height.

ZRH compressors are based on the unique Copeland Scroll design and provide the same reliability as a standard Copeland Scroll. The addition of an oil pump covers the specific needs of transport air conditioning and of horizontal compressor arrangement in general. The low profile design and modulation capabilities of the ZRH compressor range are the ideal response to these market needs.



Horizontal Scroll Compressor

ZRH Scroll Compressors Line-up R407C and R134a

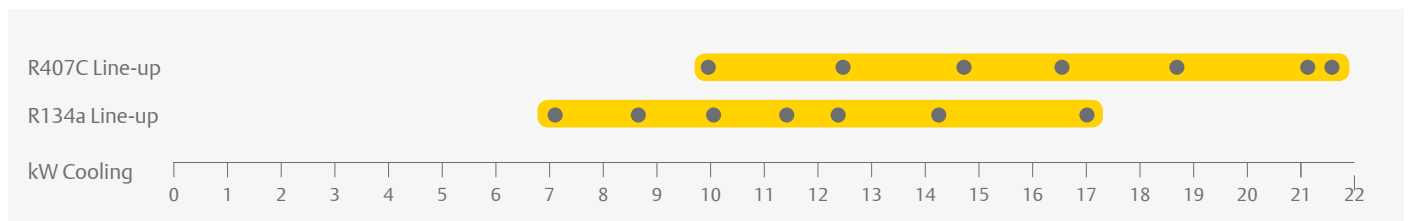

Conditions: EN12900: Evaporating 5°C, Condensing 50°C, Superheat 10K, Subcooling 0K

Features and Benefits

- Compactness and low weight
- Horizontal design with less than 250mm height
- Copeland Scroll compliance for superior reliability and efficiency
- Additional oil-pump
- Reduction of potential risk of refrigerant leakage through the drive shaft sealing
- Capacity modulation from 70% to 150% for Quest models ZRHV

Maximum Allowable Pressure (PS)

Low Side PS 21 bar(g) / High Side PS 28.8 bar(g)

Operating Envelope R407C

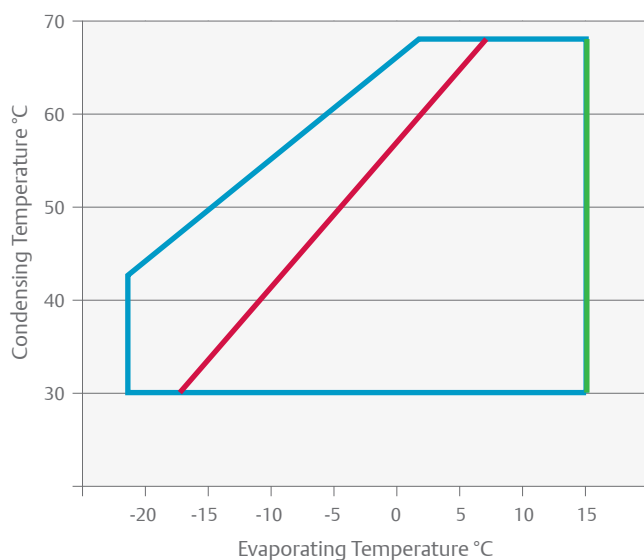

— 10K Suction Superheat — Maximum Evaporating Temperature
— 25°C Suction Gas Return

Operating Envelope R134a

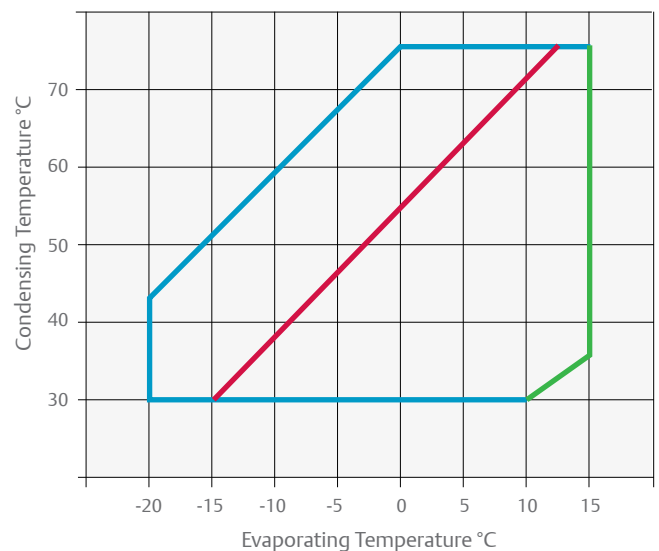

— 10K Suction Superheat — Maximum Evaporating Temperature
— 25°C Suction Gas Return

Technical Overview - Fixed Speed Models

Models	Nominal hp	Capacity (kW)	COP	Displacement (m ³ /h)	Stub Suction (inch)	Stub Discharge (inch)	Oil Quantity (l)	Length/Width/Height (mm)	Net Weight (kg)	Motor Version/Code	Maximum Operating Current (A)	Locked Rotor Current (A)	Sound Pressure @1 m - dB(A) **
										3 Ph *	3 Ph *	3 Ph *	
ZRH49KJE	4.0	10.4	2.9	11.8	7/8	1/2	1.8	487/290/231	52	TFD	9	52	66
ZRH61KJE	5.0	13.2	3.1	14.5	7/8	1/2	1.8	487/290/231	53	TFD	12	64	67
ZRH72KJE	6.0	15.2	3.1	17.1	7/8	1/2	1.8	487/290/231	54	TFD	12	74	68
ZRH78KTE	7.0	16.7	3.0	19.8	1 3/8	7/8	1.6	585/313/250	60	TFD	14	100	74
ZRH87KTE	7.5	18.8	3.0	22.1	1 3/8	7/8	1.6	585/313/250	60	TFD	16	95	74
ZRH100KTE	9.0	21.5	3.1	24.9	1 3/8	7/8	1.6	585/313/250	63	TFD	18	111	74
ZRH116KTE	10.0	25.1	3.1	29.1	1 3/8	7/8	1.6	585/313/250	64	TFD	20	118	74

Conditions: EN12900 R407C - HT: Evaporating +5°C, Condensing +50°C, suction Superheat 10K, Subcooling 0K

*TFD: 3Ph 380-420V/50Hz - 460/60Hz; TF5 200-220V/50Hz, 200-230V/60Hz

** @ 1m: sound pressure level at 1m distance from the compressor, free field condition

Technical Overview - Variable Speed Models

Models	Capacity (kw)		COP	Displacement (m ³ /h)	Stub Suction (inch)	Stub discharge (inch)	Oil Quantity (l)	Length/Width/Height (mm)	Net Weight (kg)	Motor Version/Code	Maximum Operating Current (A)	Locked Rotor Current (A)	Sound pressure @1 m - db(a) **
	Min	Max								3 Ph *	3 Ph *	3 Ph *	
ZRHV72KJE	13.3	22.0	2.8	17.1	7/8	1/2	1.8	487/290/231	53	TFD	15	100	66
ZRHV94KJE	18.6	32.9	2.8	23.9	1 3/8	7/8	1.6	584/305/230	60	TFD	21	140	73

Conditions: EN12900 R407C - HT: Evaporating +5°C, Condensing +50°C, Suction Superheat 10K, Subcooling 0K

*TFD: 3Ph 380-420V/50Hz - 460/60Hz; TF5 200-220V/50Hz, 200-230V/60Hz

** @ 1m: sound pressure level at 1m distance from the compressor, free field condition

Capacity Data - Fixed Speed Models

Condensing Temperature +50°C															
R134a	Cooling Capacity (kW)							R134a	Power Input (kW)						
	Evaporating Temperature (°C)								Evaporating Temperature (°C)						
Model	-15	-10	-5	0	+5	+10	+15	Model	-15	-10	-5	0	+5	+10	+15
ZRH49KJE	2.8	3.7	4.7	5.9	7.3	8.9	10.7	ZRH49KJE	2.0	1.1	2.2	2.3	2.4	2.5	2.6
ZRH61KJE	3.6	4.6	5.9	7.3	8.9	10.9	13.1	ZRH61KJE	2.3	2.5	2.6	2.7	2.8	2.9	3.1
ZRH72KJE	4.3	5.6	7.0	8.6	10.5	12.6	15.0	ZRH72KJE	2.6	2.8	3.0	3.1	3.0	3.4	3.5
ZRH78KTE	4.2	5.5	7.1	9.0	11.3	13.9	17.0	ZRH78KTE	3.5	3.6	3.7	3.8	3.8	3.9	4.0
ZRH87KTE	4.3	5.8	7.6	9.8	13.3	15.2	18.7	ZRH87KTE	3.9	4.0	4.0	4.1	4.1	4.1	4.0
ZRH100KTE	4.8	6.6	8.7	11.2	14.2	17.6	21.7	ZRH100KTE	4.2	4.4	4.4	4.5	4.4	4.5	4.5
ZRH116KTE	6.4	8.4	10.8	13.6	16.9	10.8	25.3	ZRH116KTE	5.5	5.6	5.6	5.6	5.5	5.5	5.5

Conditions: Suction Superheat 10K / Subcooling 0K

Preliminary Data

Condensing Temperature +50°C															
R407C	Cooling Capacity (kW)							R407C	Power Input (kW)						
	Evaporating Temperature (°C)								Evaporating Temperature (°C)						
Model	-15	-10	-5	0	+5	+10	+15	Model	-15	-10	-5	0	+5	+10	+15
ZRH49KJE		5.6	6.9	8.5	10.4	12.6	15.0	ZRH49KJE		3.1	3.3	3.4	3.5	3.6	3.8
ZRH61KJE		7.2	8.8	10.8	13.2	15.9	19.0	ZRH61KJE		3.8	4.0	4.2	4.3	4.5	4.6
ZRH72KJE		8.1	10.1	12.4	15.2	18.4	22.2	ZRH72KJE		4.3	4.5	4.7	4.9	5.0	5.1
ZRH78KTE			10.3	13.4	16.7	20.5		ZRH78KTE			5.4	5.5	5.5	5.5	
ZRH87KTE			15.6	14.8	18.8	23.5		ZRH87KTE			6.1	6.2	6.2	6.2	
ZRH100KTE			13.8	17.4	21.5	26.3		ZRH100KTE			6.7	6.8	6.9	6.9	
ZRH116KTE			16.1	20.2	25.1	30.8		ZRH116KTE			7.9	8.0	8.0	8.1	

Conditions: Suction Superheat 10K / Subcooling 0K

Capacity Data - Variable Speed Models

Condensing Temperature +50°C																		
R134a		Cooling Capacity (kW)						R134a		Power Input (kW)								
		Evaporating Temperature (°C)								Evaporating Temperature (°C)								
Model		-15	-10	-5	0	+5	+10	+15	Model		-15	-10	-5	0	+5	+10	+15	
ZRHV72KJE	Max		8.5	10.6	13.0	15.8	18.9	22.3	ZRH49KJE	Max		4.8	5.1	5.4	5.7	6.0	6.3	
	Min		5.1	6.3	7.8	9.5	11.3	13.4		Min		2.9	3.1	3.2	3.4	3.6	3.8	
ZRHV94KJE	Max			12.4	15.2	18.5	22.2	26.2	ZRH61KJE	Max		0.0	6.0	6.3	6.7	7.0		
	Min			8.9	10.9	13.3	15.9	18.7		Min		0.0	4.3	4.5	4.8	5.0		

Conditions: Suction Superheat 10K / Subcooling 0K

Preliminary Data

Condensing Temperature +50°C																	
R407C		Cooling Capacity (kW)						R407C		Power Input (kW)							
		Evaporating Temperature (°C)								Evaporating Temperature (°C)							
Model		-15	-10	-5	0	+5	+10	+15	Model		-15	-10	-5	0	+5	+10	+15
ZRHV72KJE	Max		11.8	14.8	18.2	22.1	26.5	31.2	ZRH49KJE	Max		6.8	7.2	7.5	7.9	8.4	8.9
	Min		7.1	8.9	10.9	13.3	15.9	18.7		Min		4.1	4.3	4.5	4.8	5.0	5.3
ZRHV94KJE	Max			17.3	21.3	25.9	31.0	36.7	ZRH61KJE	Max			8.4	8.8	9.3	9.8	10.4
	Min			12.4	15.3	18.6	22.2	26.2		Min			6.0	6.3	6.7	7.0	7.5

Conditions: Suction Superheat 10K / Subcooling 0K





Refrigeration Applications

Refrigeration Applications

Emerson offers a wide range of solutions for commercial refrigeration applications. With its long-lasting expertise in semi-hermetic reciprocating compressor technology as well as in scroll technology, we can meet the requirements for most applications - at the small end just like at the large end of commercial refrigeration.

Completed by the various offerings in the segment of refrigeration units, Emerson is able to offer the best solution and performance, whether you are looking for applications in foodservice or processing, supermarkets, hypermarkets, petrol stations or refrigerated warehousing.

Emerson prime focus for its semi-hermetic reciprocating technology is at the large end of commercial refrigeration. Here aspects such as reliability, serviceability and capacity modulation are of importance and they are perfectly provided by Emerson semi-hermetic reciprocating compressors. Innovations like the Discus™ and Stream technologies, digital modulation and CoreSense™ Diagnostics for advanced protection and preventive maintenance keep semi-hermetic at the forefront of compressor technology.

Especially when compact equipment, energy efficiency and reliability are musts, the scroll technology is the preferred choice for refrigeration applications. With developments such as vapor injection and digital modulation, scroll has become the leading technology and is widely recognized in the refrigeration market.

CoreSense™ Diagnostics is now also available as an option for the new scroll Summit series for medium and low temperature applications.

Whatever the chosen technology and product solution, Emerson's range meets the specific refrigeration needs covering the entire spectrum of medium and low temperature applications whether using standard HFCs, low GWP or natural refrigerants.

ZS*KA Copeland Scroll™ Small Compressor Range for Medium Applications

As an extension to the existing ZB*KCE scroll range, the new Copeland Scroll ZS*KA compressor range represents the latest innovation in scroll technology for refrigeration equipment covering a small size displacement range of 4 m³/h to 5 m³/h. As with other existing Copeland Scroll compressors scrolls, ZS*KA scrolls feature a scroll compliance mechanism which makes them particularly robust and reliable under severe conditions including liquid slugging.

ZS*KA models are intended for medium temperature refrigeration type systems, and are ideally suited for applications such as walk-ins, reach-ins, cold rooms, display cases, and milk tank units. They are multi-refrigerant capable and feature low sound and low vibration particularly important in the retail and food service sector and recommended for supermarket, restaurant, convenience store, and milk cooling operations.

The ZS*KA range from 1.3hp to 1.8hp is designed to provide seasonal efficiencies up to 28% higher than the equivalent hermetic reciprocating compressors. These compressors are qualified for today's HFC as well as new low GWP refrigerants and HFO blends.



ZS*KA Copeland Scroll™ Compressor Range for Medium Temperature Refrigeration Applications

ZS*KA Compressor Line-up

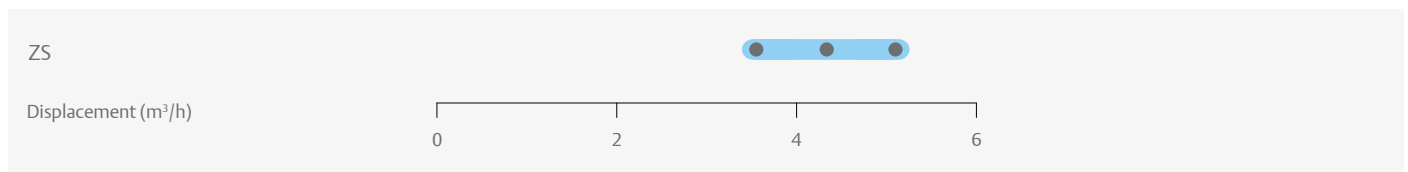

Features and Benefits

- Copeland Scroll axial and radial compliance for superior reliability and efficiency
- High seasonal efficiencies as scrolls are designed at the condition where equipment runs most of the time
- Up to 15% efficiency advantage over hermetic reciprocating compressors at rating conditions, and up to 28% improvement at lower condensing temperatures
- Availability of optional sound shell on all models providing up to 10 dBA additional sound attenuation for silent operation
- Wide operating range from -25°C to 10°C covering a minimum condensing limit of 10°C
- Qualified for R407A/F/C, R448A, R449A, R404A and R134a refrigerants

Maximum Allowable Pressure (PS)

- ZS09 to ZS13KA:
Low Side PS 21.6 bar(g) / High Side PS 31.9 bar(g)

Operating Envelope ZS*KA R134a

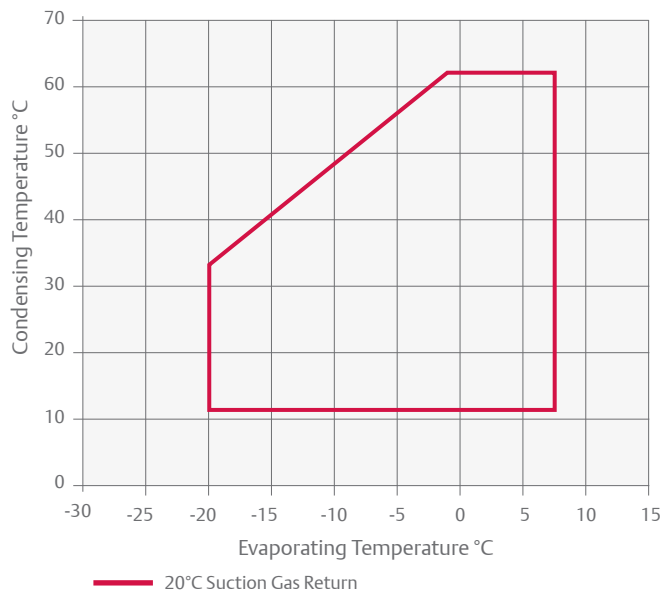

Operating Envelope ZS*KA R448A/R449A

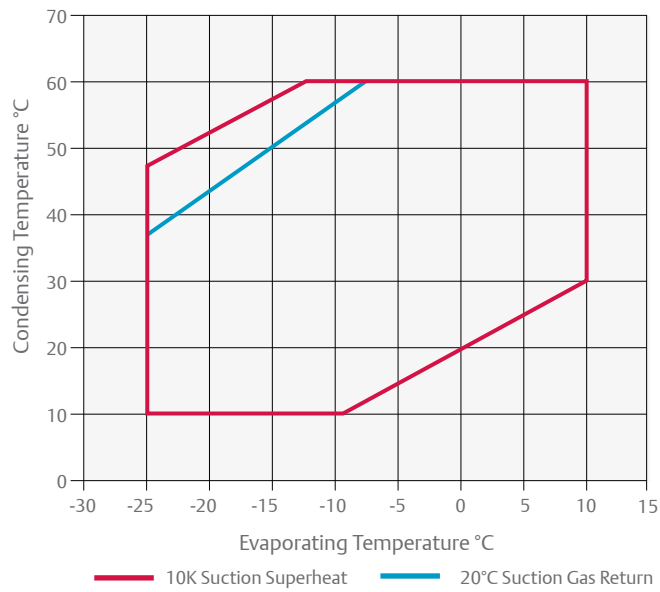

Operating Envelope ZS*KA R404A

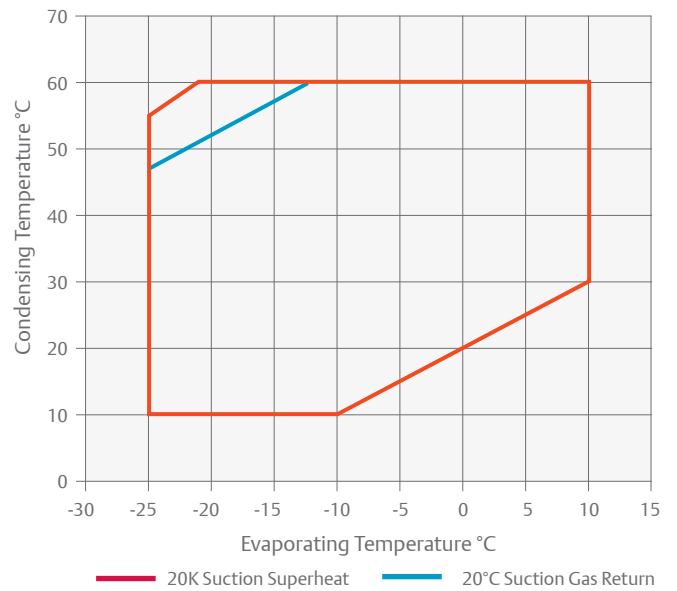

For individual model details please refer to select software

Technical Overview

Models	Nominal hp	Displacement (m ³ /h)	Rotorlock Suction (inch)	Rotorlock Discharge (inch)	Oil Quantity (l)	Length/Width/Height (mm)	Net Weight (kg)	Motor Version/ Code		Maximum Operating Current (A)		Locked Rotor Current (A)		Sound Pressure @ 1 m - dB(A)***
								1 Ph*	3 Ph**	1 Ph*	3 Ph**	1 Ph*	3 Ph**	
Medium Temperature														
ZS09KAE	1.3	3.7	3/4	1/2	0.7	246/246/387	22.2	PFJ	TFD	7.2	3.0	45.0	27.0	58.0
ZS11KAE	1.5	4.4	3/4	1/2	0.7	246/246/387	22.4	PFJ	TFD	8.7	3.3	45.0	27.0	58.0
ZS13KAE	1.8	5.0	3/4	1/2	0.7	246/246/387	21.4	PFJ	TFD	9.9	4.0	54.0	29.0	59.0

* 1Ph: 230V/ 50Hz

** 3 Ph: 380-420V/ 50Hz

*** @ 1m: sound pressure level at 1m distance from the compressor, free field condition

Capacity Data

Condensing Temperature 40°C															
R407A	Cooling Capacity (kW)							R407A	Power Input (kW)						
	Evaporating Temperature (°C)								Evaporating Temperature (°C)						
Model	-35	-30	-25	-20	-15	-10	-5	Model	-35	-30	-25	-20	-15	-10	-5
Medium Temperature															
ZS09KAE				0.9	1.1	1.4	1.7	ZS09KAE				0.5	0.6	0.6	0.6
ZS11KAE				1.1	1.3	1.7	2.0	ZS11KAE				0.6	0.7	0.7	0.7
ZS13KAE				1.2	1.5	1.9	2.3	ZS13KAE				0.7	0.8	0.8	0.8

Conditions: Suction Gas Return 20°C / Subcooling 0K

Condensing Temperature 40°C															
R407F	Cooling Capacity (kW)							R407F	Power Input (kW)						
	Evaporating Temperature (°C)								Evaporating Temperature (°C)						
Model	-35	-30	-25	-20	-15	-10	-5	Model	-35	-30	-25	-20	-15	-10	-5
Medium Temperature															
ZS09KAE			1.2*	1.5	1.9	2.3	2.7	ZS09KAE			0.8*	0.8	0.9	0.9	0.9
ZS11KAE			1.4*	1.8	2.2	2.7	3.3	ZS11KAE			1.0*	1.0	1.1	1.1	1.1
ZS13KAE			1.6*	2.1	2.6	3.1	3.7	ZS13KAE			1.1*	1.2	1.2	1.2	1.3

Conditions: Suction Gas Return 20°C / Subcooling 0K

*Conditions: Suction Superheat 10K, Subcooling 0K

Preliminary Data

Capacity Data

Condensing Temperature 40°C															
R448A/ R449A	Cooling Capacity (kW)							R448A/ R449A	Power Input (kW)						
	Evaporating Temperature (°C)								Evaporating Temperature (°C)						
Model	-35	-30	-25	-20	-15	-10	-5	Model	-35	-30	-25	-20	-15	-10	-5
Medium Temperature															
ZS09KAE			1.0*	1.5	1.9	2.3	2.7	ZS09KAE			0.8*	0.8	0.9	0.9	0.9
ZS11KAE			1.2*	1.8	2.2	2.7	3.3	ZS11KAE			1.0*	1.0	1.1	1.1	1.1
ZS13KAE			1.4*	2.1	2.6	3.1	3.7	ZS13KAE			1.1*	1.2	1.2	1.2	1.3

Conditions: Suction Gas Return 20°C / Subcooling 0K

*Conditions: Suction Superheat 10K, Subcooling 0K

Condensing Temperature 40°C															
R404A	Cooling Capacity (kW)							R404A	Power Input (kW)						
	Evaporating Temperature (°C)								Evaporating Temperature (°C)						
Model	-35	-30	-25	-20	-15	-10	-5	Model	-35	-30	-25	-20	-15	-10	-5
Medium Temperature															
ZS09KAE			1.1*	1.5	1.9	2.3	2.8	ZS09KAE			0.9*	0.9	1.0	1.0	1.0
ZS11KAE			1.3*	1.9	2.3	2.8	3.3	ZS11KAE			1.0*	1.1	1.1	1.2	1.2
ZS13KAE			1.5*	2.1	2.6	3.1	3.8	ZS13KAE			1.2*	1.3	1.3	1.4	1.4

Conditions: Suction Gas Return 20°C / Subcooling 0K

*Conditions: Suction Superheat 10K, Subcooling 0K

Condensing Temperature 40°C															
R134a	Cooling Capacity (kW)							R134a	Power Input (kW)						
	Evaporating Temperature (°C)								Evaporating Temperature (°C)						
Model	-35	-30	-25	-20	-15	-10	-5	Model	-35	-30	-25	-20	-15	-10	-5
Medium Temperature															
ZS09KAE			0.9	1.1	1.4	1.7	2.8	ZS09KAE			0.5	0.6	0.6	0.6	1.0
ZS11KAE			1.1	1.3	1.7	2.0	3.3	ZS11KAE			0.6	0.7	0.7	0.7	1.2
ZS13KAE			1.2	1.5	1.9	2.3	3.8	ZS13KAE			0.7	0.8	0.8	0.8	1.4

Conditions: Suction Gas Return 20°C / Subcooling 0K

ZB Copeland Scroll™ Compressor Ranges for Medium Temperature Refrigeration Using R407A/F/C, R448A/R449A, R404A, R134a, R450A and R513A

Emerson offers ZB compressors with a wide displacement range from 5.9 m³/h to 87.5 m³/h. It includes digital compressor models that offers continuous capacity modulation technology.

Copeland Scroll compressors have 3 times less moving parts than reciprocating compressors and feature a scroll compliance mechanism which makes them particularly robust and reliable under severe conditions including liquid slugging.

They have the advantage of light weight and compactness, making them ideal for the usage in refrigeration units, compact refrigeration systems or special process units.

The Summit Series from 7 to 15 hp is designed to provide seasonal efficiencies 15% higher than traditional semi-hermetic compressors. These compressors are extremely quiet and can be fitted with an external sound shell for an additional 10 dBA sound reduction, which makes them best choice for refrigeration applications in urban and domestic areas.

The ZB range also features ZB220 (30hp), the largest refrigeration scroll available on the market. These compressors are qualified for R407A/F/C, R448A, R449A, R404A and R134a. CoreSense™ Diagnostics is now available as an option for the ZB Scroll Summit series (ZB66K5E, ZB76K5E, ZB95K5E and ZB114K5E) as well as for Summit Digital ZBD*K5E Series.



ZB Compressor for Medium Temperature Refrigeration With and Without Sound Shell

For more details on digital models please refer to page 58 in the catalogue.

ZB and ZBD Compressor Line-up

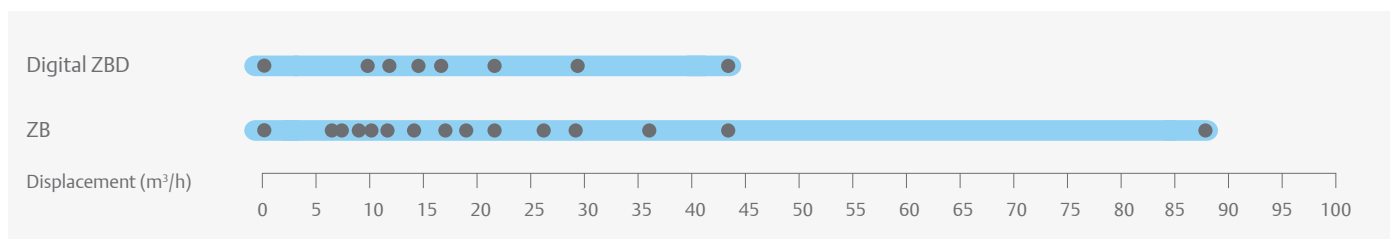

Features and Benefits

- Copeland Scroll axial and radial compliance for superior reliability and efficiency
- Wide operating envelope with 10°C condensing limit and fast pull-down capabilities
- High seasonal efficiencies as scrolls are designed at the condition where equipment runs most of the time
- Light weight and compactness, up to half the weight of equivalent semi-hermetic compressors
- Availability of optional sound shell on all models providing an additional 10 dBA sound attenuation for silent operation
- Includes 12 Digital Scroll compressor models for simple, stepless 10 to 100% capacity modulation
- One model for multiple refrigerants R407A/F/C, R448A/R449A, R404A, R134a, R450A and R513A

Maximum Allowable Pressure (PS)

- ZB15 to ZB45:
Low Side PS 21 bar(g) / High Side PS 32 bar(g)
- ZB50 to ZB220:
Low Side PS 22.6 bar(g) / High Side PS 32 bar(g)
- Digital ZBD:
Low Side PS 21 bar(g) / High Side PS 28.8 bar(g)
- Summit ZBD:
Low Side PS 22.6 bar(g) / High Side PS 32 bar (g)

Operating Envelope R448A/R449A

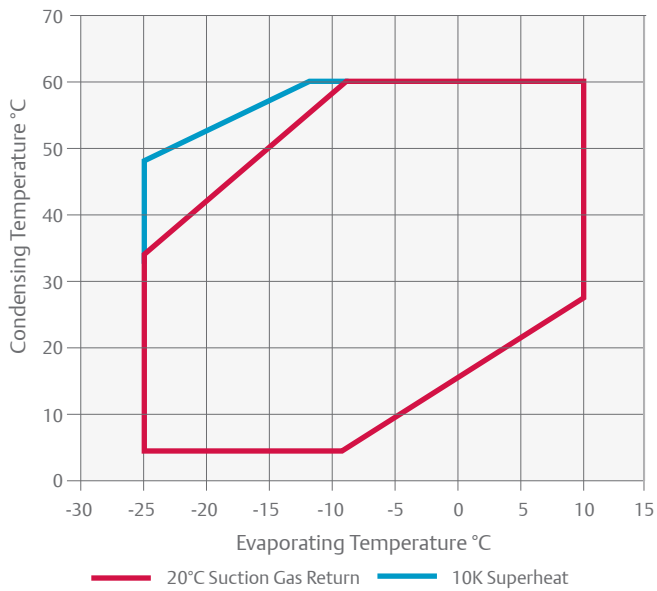

Operating Envelope R407A

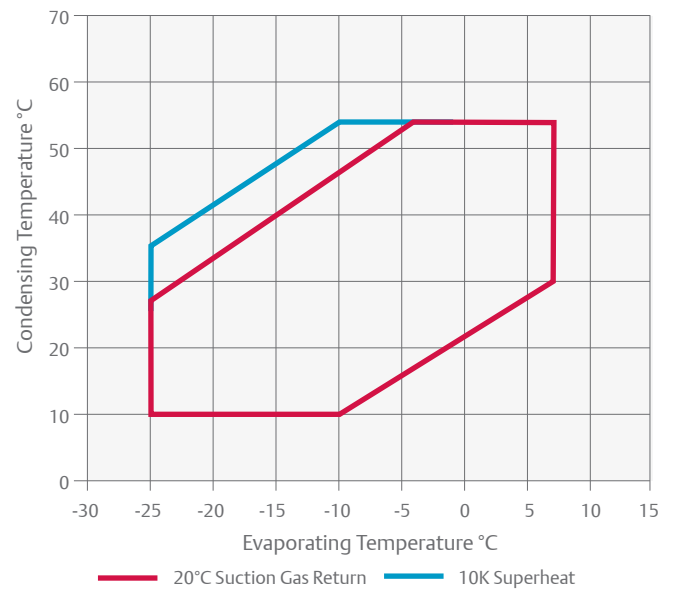

Operating Envelope R134a - for ZBD Digital Models

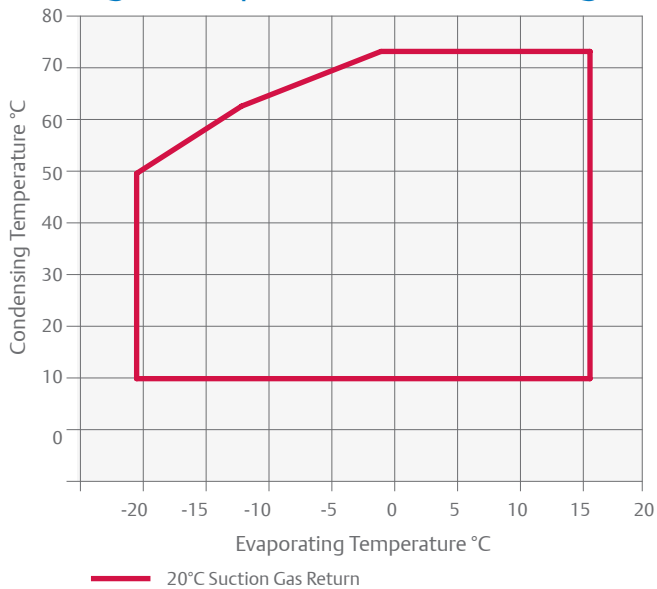

For individual model details please refer to select software.

Technical Overview

Models	Nominal hp	Displacement (m ³ /h)	Rotolock suction (inch)	Rotolock Discharge (inch)	Oil Quantity (l)	Length/Width/Height (mm)	Net Weight (kg)	Motor Version/Code		Maximum Operating Current (A)		Locked Rotor Current (A)		Sound Pressure @ 1 m - dB(A)***
								1 Ph*	3 Ph**	1 Ph*	3 Ph**	1 Ph*	3 Ph**	
ZB15KCE	2.0	5.9	1 1/4	1	1.3	241/241/369	25.4	PFJ	TFD	12.8	4.9	58.0	26.0	55.0
ZB19KCE	2.5	6.8	1 1/4	1	1.5	242/242/369	27.2	PFJ	TFD	12.8	6.5	61.0	32.0	55.0
ZB21KCE	3.0	8.6	1 1/4	1	1.2	243/244/391	29.0	PFJ	TFD	16.4	7.2	82.0	40.0	58.0
ZB26KCE	3.5	10.0	1 1/4	1	1.5	243/244/405	28.0	PFJ	TFD	18.0	8.9	97.0	46.0	60.0
ZB29KCE	4.0	11.4	1 1/4	1	1.5	246/246/423	28.6		TFD		10.0		50.0	58.0
ZB38KCE	5.0	14.4	1 1/4	1	1.9	242/242/438	37.4	PFJ	TFD	32.3	12.8	142.0	65.5	61.0
ZB42KCE	5.5	16.2	1 1/4	1	1.9	251/246/438	43.0	PFJ		35.7		150.0		62.0
ZB45KCE	6.0	17.1	1 1/4	1	1.9	242/242/438	39.5		TFD		13.1		74.0	61.0
ZB48KCE	6.5	18.8	1 1/4	1 1/4	1.8	246/250/442	39.0		TFD		14.0		101.0	62.0
ZB57KCE		21.4	1 1/4	1 1/4	1.9	246/256/442	39.5		TFD		15.9		102.0	68.0
ZB220KCE	30.0	87.5	2 3/4	1 3/4	6.3	448/392/715	176.0		TWM		69.0		310.0	78.0
ZB Summit Models														
ZB66K5E	10.0	25.7	1 3/4	1 1/4	3.4	280/280/534	59.9		TFD		17.5		111.0	66.0
ZB76K5E	12.0	28.8	1 3/4	1 1/4	3.4	280/280/534	61.2		TFD		20.4		118.0	67.0
ZB95K5E	13.0	36.4	1 3/4	1 1/4	3.4	280/280/552	64.9		TFD		28.2		140.0	69.0
ZB114K5E	15.0	43.4	1 3/4	1 1/4	3.4	280/280/552	66.2		TFD		33.5		174.0	72.0

* 1Ph: 230V/ 50Hz

** 3 Ph: 380-420V/ 50Hz

*** @ 1m: sound pressure level at 1m distance from the compressor, free field condition

Capacity Data

Condensing Temperature 40°C															
R407A	Cooling Capacity (kW)							R407A	Power Input (kW)						
	Evaporating Temperature (°C)								Evaporating Temperature (°C)						
Model	-35	-30	-25	-20	-15	-10	-5	Model	-35	-30	-25	-20	-15	-10	-5
ZB15KCE				2.1*	2.8	3.5	4.2	ZB15KCE				1.5*	1.5	1.5	1.5
ZB19KCE				2.6*	3.4	4.2	5.2	ZB19KCE				1.7*	1.8	1.8	1.8
ZB21KCE				3.0*	4.0	5.1	6.3	ZB21KCE				2.0*	2.0	2.0	2.1
ZB26KCE				3.6*	4.7	5.8	7.1	ZB26KCE				2.3*	2.3	2.3	2.4
ZB29KCE				4.2*	5.6	7.0	8.6	ZB29KCE				2.6*	2.6	2.6	2.6
ZB38KCE				5.4*	7.2	8.9	11.0	ZB38KCE				3.2*	3.3	3.3	3.4
ZB42KCE**				6.1*	7.9	9.8	12.0	ZB42KCE**				3.9*	3.9	3.9	3.9
ZB45KCE				6.3*	8.2	10.2	12.4	ZB45KCE				3.9*	4.0	4.0	4.0
ZB48KCE				7.3*	9.5	11.7	14.3	ZB48KCE				4.5*	4.5	4.6	4.5
ZB57KCE				8.4*	11.1	13.8	17.0	ZB57KCE				5.2*	5.2	5.3	5.3
ZB Summit Models															
ZB66K5E				9.2*	12.4	15.6	19.3	ZB66K5E				5.5*	5.5	5.7	5.8
ZB76K5E				10.6*	14.2	18.1	22.4	ZB76K5E				6.5*	6.5	6.7	6.9
ZB95K5E				12.9*	17.7	22.5	27.8	ZB95K5E				8.3*	8.3	8.5	8.7
ZB114K5E				14.8*	20.5	26.3	32.8	ZB114K5E				10.2*	10.2	10.3	10.5

Suction Gas Return 20°C / Subcooling 0K

*Suction Superheat 10K

** Single Phase Only

Preliminary Data

Condensing Temperature 40°C															
R407F	Cooling Capacity (kW)							R407F	Power Input (kW)						
	Evaporating Temperature (°C)								Evaporating Temperature (°C)						
Model	-35	-30	-25	-20	-15	-10	-5	Model	-35	-30	-25	-20	-15	-10	-5
ZB15KCE					2.6*	3.4	4.2	ZB15KCE					1.6*	1.6	1.6
ZB19KCE					3.2*	4.2	5.1	ZB19KCE					1.9*	1.9	1.9
ZB21KCE					3.9*	5.0	6.2	ZB21KCE					2.2*	2.2	2.3
ZB26KCE					4.5*	5.8	7.2	ZB26KCE					2.6*	2.6	2.6
ZB29KCE					5.4*	7.0	8.7	ZB29KCE					2.8*	2.9	2.8
ZB38KCE				5.2*	6.9*	8.9	11.0	ZB38KCE				3.7*	3.7*	3.7	3.7
ZB42KCE**				5.9*	7.8*	10.1	12.5	ZB42KCE**				4.0*	4.0*	4.0	4.0
ZB45KCE				6.0*	8.1*	10.5	13.0	ZB45KCE				4.1*	4.2*	4.3	4.2
ZB48KCE				7.0*	9.3*	12.1	15.0	ZB48KCE				4.7*	4.8*	4.9	4.9
ZB57KCE				7.9*	10.6*	13.7	16.8	ZB57KCE				4.7*	5.0*	5.3	5.5
ZB Summit Models															
ZB66K5E				9.5*	13.0*	16.9	20.9	ZB66K5E				5.8*	5.8*	5.9	6.1
ZB76K5E				10.9*	15.0*	19.6	24.2	ZB76K5E				6.9*	6.8*	7.0	7.2
ZB95K5E				13.3*	18.6*	24.4	30.1	ZB95K5E				8.8*	8.8*	8.9	9.1
ZB114K5E				15.3*	21.5*	28.5	35.4	ZB114K5E				10.7*	10.7*	10.8	11.0

Suction Gas Return 20°C / Subcooling 0K

*Suction Superheat 10K

** Single Phase Only

Preliminary Data

Capacity Data

Condensing Temperature 40°C															
R448A/ R449A	Cooling Capacity (kW)							R448A/ R449A	Power Input (kW)						
	Evaporating Temperature (°C)								Evaporating Temperature (°C)						
Model	-35	-30	-25	-20	-15	-10	-5	Model	-35	-30	-25	-20	-15	-10	-5
ZB15KCE			1.5*	2.2	2.8	3.5	4.3	ZB15KCE			1.6*	1.5	1.5	1.4	1.4
ZB19KCE			1.9*	2.6	3.2	4.0	4.9	ZB19KCE			1.7*	1.7	1.7	1.7	1.7
ZB21KCE			2.5*	3.3	4.2	5.2	6.4	ZB21KCE			2.0*	2.0	2.0	2.0	2.0
ZB26KCE			2.9*	3.9	4.9	6.0	7.4	ZB26KCE			2.3*	2.4	2.4	2.4	2.4
ZB29KCE			3.3*	4.4	5.5	6.8	8.2	ZB29KCE			2.6*	2.6	2.6	2.7	2.7
ZB38KCE			3.9*	5.7	7.2	8.9	10.9	ZB38KCE			3.4*	3.4	3.4	3.4	3.4
ZB42KCE**			4.4*	6.4	8.1	10.1	12.3	ZB42KCE**			3.9*	3.9	3.9	3.9	3.9
ZB45KCE			4.5*	6.6	8.4	10.5	12.8	ZB45KCE			3.9*	3.9	3.9	3.9	3.9
ZB48KCE			5.3*	7.6	9.7	12.1	14.7	ZB48KCE			4.5*	4.5	4.5	4.5	4.5
ZB57KCE			6.0*	8.7	11.0	13.6	16.5	ZB57KCE			4.3*	4.5	4.7	4.9	5.1
ZB220KCE				32.4*	43.1	53.7	65.7	ZB220KCE				20.3*	20.3	20.4	20.6
ZB Summit Models															
ZB66K5E			6.8*	9.4*	12.7	15.8	19.3	ZB66K5E			5.8*	5.8*	5.8	5.8	5.8
ZB76K5E			8.0*	11.1*	14.9	18.6	22.7	ZB76K5E			6.5*	6.6*	6.6	6.6	6.7
ZB95K5E			8.8*	13.2*	18.2	22.8	27.8	ZB95K5E			8.7*	8.6*	8.6	8.6	8.7
ZB114K5E			10.6*	15.6*	21.5	27.3	33.7	ZB114K5E			10.5*	10.3*	10.3	10.3	10.4

Suction Gas Return 20°C / Subcooling 0K

*Suction Superheat 10K, Subcooling 0K

** Single Phase Only

Preliminary Data

Capacity Data

Condensing Temperature 40°C															
R404A	Cooling Capacity (kW)							R404A	Power Input (kW)						
	Evaporating Temperature (°C)								Evaporating Temperature (°C)						
Model	-35	-30	-25	-20	-15	-10	-5	Model	-35	-30	-25	-20	-15	-10	-5
ZB15KCE			1.9	2.4	3.0	3.7	4.5	ZB15KCE			1.7	1.7	1.6	1.6	1.5
ZB19KCE			2.3	2.9	3.5	4.2	5.1	ZB19KCE			1.9	1.9	1.9	1.9	1.9
ZB21KCE			3.0	3.7	4.5	5.5	6.6	ZB21KCE			2.2	2.2	2.2	2.2	2.2
ZB26KCE			3.5	4.3	5.3	6.4	7.6	ZB26KCE			2.6	2.6	2.6	2.6	2.6
ZB29KCE			4.0	4.9	6.0	7.2	8.6	ZB29KCE			2.9	2.9	2.9	2.9	2.9
ZB38KCE			5.1	6.3	7.7	9.3	11.2	ZB38KCE			3.8	3.8	3.8	3.8	3.8
ZB42KCE**			5.7	7.1	8.7	10.6	12.7	ZB42KCE**			4.2	4.2	4.2	4.2	4.2
ZB45KCE			6.0	7.4	9.1	11.0	13.2	ZB45KCE			4.3	4.3	4.3	4.3	4.3
ZB48KCE			6.9	8.6	10.5	12.7	15.2	ZB48KCE			4.9	4.9	4.9	4.9	4.9
ZB57KCE			7.9	9.7	11.9	14.3	17.1	ZB57KCE			4.7	4.9	5.2	5.4	5.5
ZB220KCE			28.5*	39.2	47.7	57.5	68.9	ZB220KCE			21.4*	21.8	22.0	22.2	22.4
ZB Summit Models															
ZB66K5E			9.1	11.4	13.9	16.8	20.1	ZB66K5E			6.2	6.2	6.2	6.3	6.4
ZB76K5E			10.5	13.1	16.2	19.7	23.6	ZB76K5E			7.2	7.2	7.3	7.4	7.5
ZB95K5E			10.7*	16.0	20.1	24.5	29.3	ZB95K5E			9.3*	9.2	9.3	9.3	9.4
ZB114K5E			12.5*	18.7	23.4	28.7	34.7	ZB114K5E			11.3*	11.3	11.3	11.4	11.4

Suction Gas Return 20°C / Subcooling 0K

*Suction Superheat 10K, Subcooling 0K

** Single Phase Only

Condensing Temperature 40°C															
R134a	Cooling Capacity (kW)							R134a	Power Input (kW)						
	Evaporating Temperature (°C)								Evaporating Temperature (°C)						
Model	-35	-30	-25	-20	-15	-10	-5	Model	-35	-30	-25	-20	-15	-10	-5
ZB15KCE				1.4	1.7	2.2	2.7	ZB15KCE				0.9	0.9	0.9	0.9
ZB19KCE				1.6	2.0	2.5	3.1	ZB19KCE				1.1	1.1	1.1	1.1
ZB21KCE				2.0	2.5	3.2	4.0	ZB21KCE				1.3	1.3	1.3	1.3
ZB26KCE				2.3	2.9	3.7	4.6	ZB26KCE				1.5	1.5	1.5	1.5
ZB29KCE				2.5	3.2	4.0	5.0	ZB29KCE				1.7	1.7	1.7	1.7
ZB38KCE				3.2	4.2	5.4	6.7	ZB38KCE				2.1	2.1	2.1	2.2
ZB42KCE**				3.8	4.8	6.0	7.5	ZB42KCE**				2.5	2.5	2.5	2.4
ZB45KCE				4.0	5.1	6.4	8.0	ZB45KCE				2.4	2.4	2.5	2.5
ZB48KCE				4.8	6.0	7.5	9.1	ZB48KCE				2.8	2.8	2.9	2.9
ZB57KCE				5.0	6.4	8.1	10.1	ZB57KCE				3.4	3.4	3.4	3.5
ZB220KCE					27.3	34.1	42.1	ZB220KCE					13.0	13.2	13.5
ZB Summit Models															
ZB66K5E				6.0	7.5	9.5	11.8	ZB66K5E				3.8	3.7	3.8	3.8
ZB76K5E				6.9	8.6	10.8	13.5	ZB76K5E				4.4	4.4	4.4	4.5
ZB95K5E				8.2	10.8	13.8	17.1	ZB95K5E				5.4	5.5	5.5	5.6
ZB114K5E				9.6	12.7	16.3	20.4	ZB114K5E				6.6	6.6	6.7	6.7

Suction Gas Return 20°C / Subcooling 0K

** Single Phase Only

ZF Copeland Scroll™ Compressor Ranges for Low Temperature Refrigeration Using R407A/F, R448A/R449A and R404A

Emerson developed the ZF range to provide the best performance in low temperature. The range has a wide application envelope as it can operate from -40°C evaporating temperature to +7°C. They have been optimized in their design to perfectly fit frozen food application requirements. Thanks to their scroll compliance mechanism, these scroll compressors feature particularly high tolerance to liquid slugging.

The range consists of:

- The ZF*K4E models that operate with liquid injection in order to control discharge temperature and increase the operating envelope.
- The ZF*KVE models that are optimized for vapor injection with use of a sub-cooler. This boosts refrigeration system's cooling capacity and efficiency.
- The Summit ZF* K5E models that operate both with liquid injection or vapor injection.

These compressors are qualified for R407A/F, R448A/R449A, R404A and R134a for certain models. For more details on Digital Scroll models please refer to page 58 in the catalogue.

CoreSense™ Diagnostics is now available as an option for the ZF Scroll Summit series (ZF34K5E-ZF54K5E) as well as for Summit Digital ZFD41K5E.



ZF Compressor for Low Temperature Refrigeration With and Without Sound Shell

ZF and ZFD Compressor Line-Up

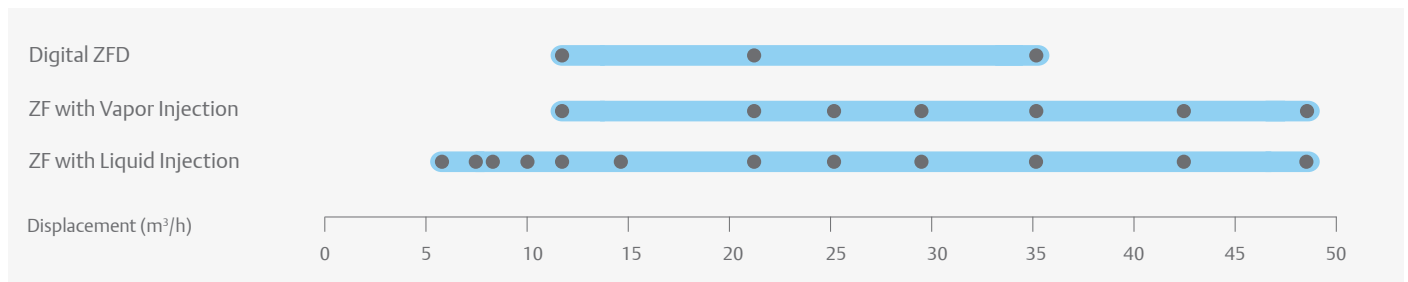

Features and Benefits

- Wide operating envelope with 10°C low condensing temperature to minimize energy consumption
- One model for multiple refrigerants
- Light weight and compactness, up to half the weight of equivalent semi-hermetic compressor
- Optional Sound Shell allowing up to 10 dBA sound attenuation
- ZF models with liquid injection
 - Easy, efficient and reliable injection via Discharge Temperature Control Valve (DTC)
- ZF models with enhanced vapor injection
 - Seasonal efficiencies compared to Emerson's best semi-hermetic compressors
 - Improved system capacity and efficiency by 40% and 25% respectively, making them the most efficient compressors on the market.
 - Possibility to reduce the equipment and component sizes by using smaller compressors

Maximum Allowable Pressure (PS)

- ZF06 to ZF18 (K4E/KVE):
Low Side PS 21 bar(g) / High Side PS 32 bar(g)
- ZF25 to ZF54 (K5E):
Low Side PS 22.6 bar(g) / High Side PS 32 bar(g)
- Digital ZFD:
Low Side PS 22.6 bar(g) / High Side PS 32 bar(g)

Operating Envelope R407A

For Vapor Injection

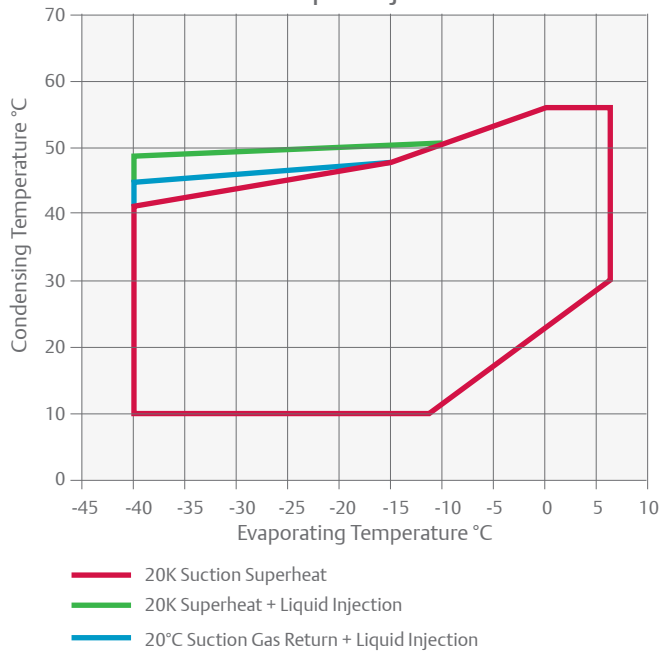

For Liquid Injection

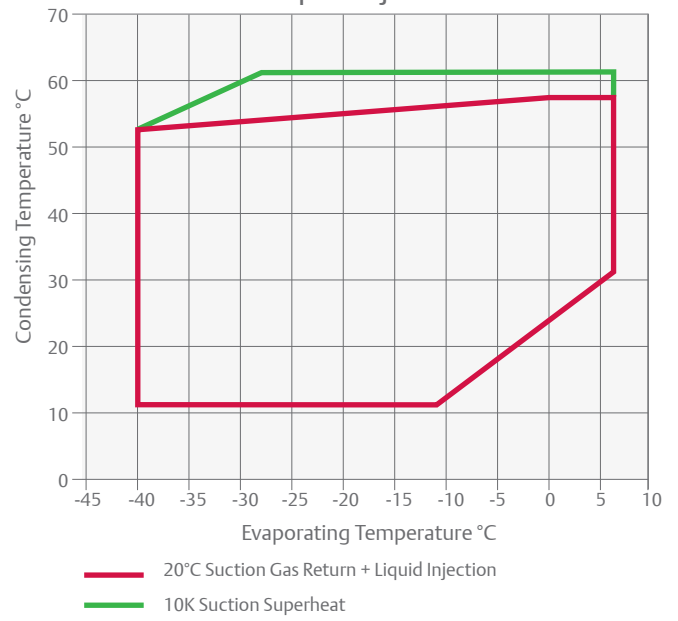

Operating Envelope R407F

For Vapor Injection

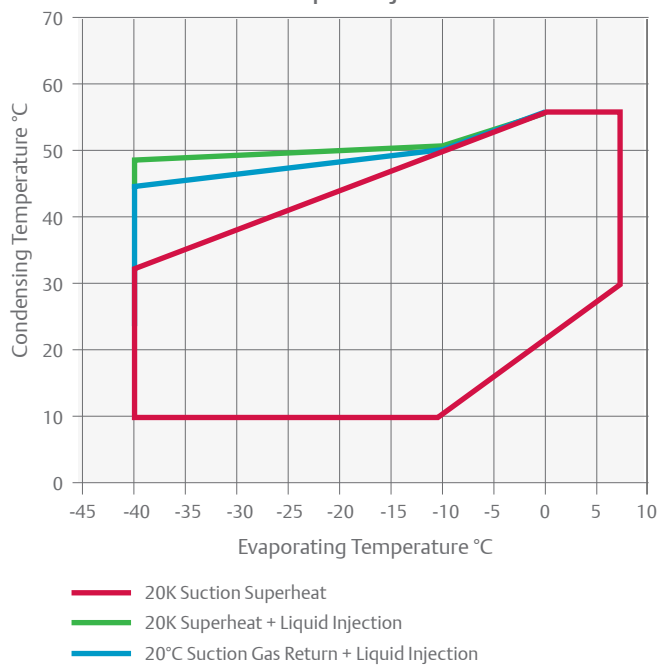

For Liquid Injection

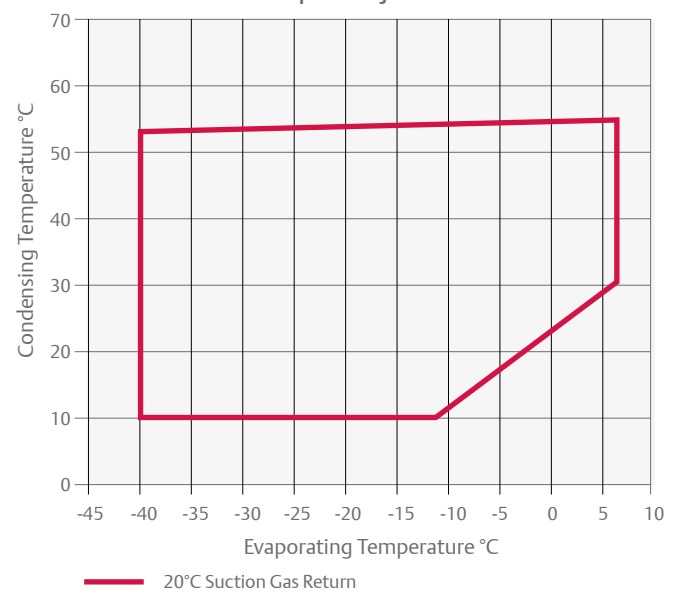

Operating Envelope R448A/R449A

For Liquid Injection

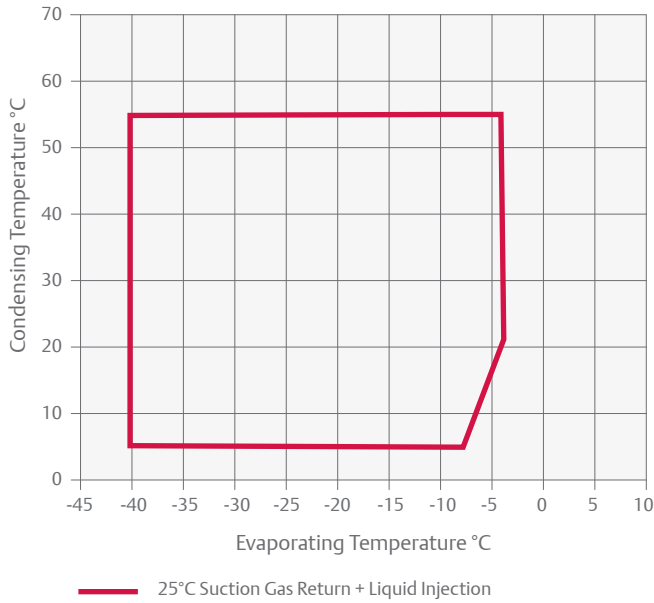

For individual model details please refer to Select Software.

Technical Overview

Models	Nominal hp	Displacement (m ³ /h)	Rotolock Suction (inch)	Rotolock Discharge (inch)	Oil Quantity (l)	Length/Width/Height (mm)	Net Weight (kg)	Motor Version/Code	Maximum Operating Current (A)	Locked Rotor Current (A)	Sound Pressure @ 1 m - db(A)***
								3 Ph**	3 Ph**	3 Ph**	
Models with Liquid Injection											
ZF06K4E	2.0	5.9	1 1/4	1	1.3	243/245/369	25.4	TFD	5.0	26.0	57.0
ZF08K4E	2.5	7.3	1 1/4	1	1.5	243/245/391	27.2	TFD	6.0	32.0	59.0
ZF09K4E	2.8	8.0	1 1/4	1	1.5	243/244/391	27.0	TFD	6.0	40.0	62.0
ZF11K4E	3.5	9.9	1 1/4	1	1.5	243/244/405	28.0	TFD	7.1	46.0	63.0
ZF13K4E	4.0	11.8	1 1/4	1	1.9	246/251/442	38.0	TFD	8.0	51.5	65.0
ZF15K4E	5.0	14.5	1 1/4	1	1.9	246/251/442	39.0	TFD	10.0	64.0	65.0
ZF18K4E	6.0	17.1	1 1/4	1	1.9	246/251/442	41.0	TFD	12.5	74.0	67.0
ZF Summit Models with Liquid Injection											
ZF25K5E	7.5	21.4	1 1/4	1 1/4	1.9	246/257/452	39.5	TFD	16.0	102.0	70.0
ZF34K5E	10.0	29.1	1 3/4	1 1/4	3.4	280/280/534	63.1	TFD	25.0	100.0	68.0
ZF41K5E	13.0	35.3	1 3/4	1 1/4	3.4	280/280/534	63.1	TFD	29.0	118.0	69.0
ZF49K5E	15.0	42.4	1 3/4	1 1/4	3.4	280/280/552	66.2	TFD	30.0	139.0	72.0
ZF54K5E	17.0	48.3	1 3/4	1 1/4	3.4	363/312/552	66.2	TFD	31.0	168.0	78.0
Models with Enhanced Vapor Injection											
ZF13KVE EVI	4.0	11.7	1 1/4	1	1.9	246/251/442	38.0	TFD	9.0	64.0	63.0
ZF18KVE EVI	6.0	17.1	1 1/4	1	1.9	246/251/442	39.5	TFD	13.7	74.0	67.0

** 3 Ph: 380-420V/ 50Hz

*** @ 1m: sound pressure level at 1m distance from the compressor, free field condition

Capacity Data

Condensing Temperature 40°C															
Models with Liquid Injection															
R407A	Cooling Capacity (kW)							R407A	Power Input (kW)						
	Evaporating Temperature (°C)								Evaporating Temperature (°C)						
Model	-35	-30	-25	-20	-15	-10	-5	Model	-35	-30	-25	-20	-15	-10	-5
ZF06K4E	1.2	1.5	1.9	2.3	2.8	3.5	4.2	ZF06K4E	1.2	1.2	1.2	1.3	1.4	1.4	1.5
ZF08K4E	1.4	1.9	2.4	3.0	3.6	4.4	5.3	ZF08K4E	1.4	1.4	1.5	1.6	1.6	1.7	1.8
ZF09K4E	1.6	2.0	2.6	3.2	3.9	4.8	5.9	ZF09K4E	1.5	1.5	1.6	1.6	1.7	1.8	1.9
ZF11K4E	2.0	2.6	3.2	4.0	4.9	6.0	7.3	ZF11K4E	1.9	1.9	1.9	2.0	2.0	2.2	2.3
ZF13K4E	2.2	2.9	3.6	4.5	5.6	6.8	8.3	ZF13K4E	2.3	2.3	2.4	2.5	2.5	2.6	2.8
ZF15K4E	2.7	3.5	4.4	5.5	6.8	8.4	10.2	ZF15K4E	2.7	2.8	2.9	3.1	3.2	3.4	3.6
ZF18K4E	3.3	4.3	5.4	6.7	8.3	10.2	12.4	ZF18K4E	3.3	3.4	3.5	3.6	3.8	3.9	4.1
Models with Enhanced Vapor Injection															
ZF13KVE EVI	3.1	4.0	4.9	6.0	7.3	8.7	10.4	ZF13KVE EVI	2.3	2.3	2.4	2.5	2.6	2.7	2.7
ZF18KVE EVI	4.9	6.0	7.3	8.8	10.8	13.3	16.4	ZF18KVE EVI	3.4	3.5	3.6	3.7	3.9	4.1	4.4
ZF Summit Models - with Liquid Injection															
ZF25K5E	4.3	5.5	6.9	8.6	10.7	13.2	16.0	ZF25K5E	4.0	4.2	4.5	4.7	4.9	5.2	5.4
ZF34K5E	5.9	7.6	9.6	12.1	15.0	18.3	22.3	ZF34K5E	5.1	5.5	5.9	6.2	6.6	6.9	7.3
ZF41K5E	7.3	9.3	11.7	14.5	17.9	21.8	26.4	ZF41K5E	6.2	6.7	7.1	7.6	8.0	8.4	8.9
ZF49K5E	8.6	11.2	14.1	17.7	21.9	26.8	32.5	ZF49K5E	7.6	8.2	8.7	9.2	9.7	10.2	10.7
ZF54K5E	9.4	12.0	15.0	18.6	22.7			ZF54K5E	7.3	7.9	8.4	9.0	9.6		
ZF Summit Models - with Enhanced Vapor Injection															
ZF25K5E EVI	6.1	7.7	9.4	11.4	13.5	15.8	18.2	ZF25K5E EVI	4.3	4.4	4.6	4.8	5.0	5.3	5.5
ZF34K5E EVI	8.0	9.9	12.1	14.6	17.4	20.7	24.2	ZF34K5E EVI	5.3	5.5	5.7	5.9	6.1	6.3	6.4
ZF41K5E EVI	10.1	12.6	15.5	18.7	22.1	25.8	29.7	ZF41K5E EVI	6.7	6.9	7.2	7.4	7.6	7.8	8.0
ZF49K5E EVI	12.1	15.1	18.4	22.3	26.8			ZF49K5E EVI	8.0	8.3	8.5	8.8	9.1		

Suction Gas Return 20°C / Subcooling 0K

Preliminary Data

Capacity Data

Condensing Temperature 40°C															
Models with Liquid Injection															
R407F	Cooling Capacity (kW)							R407F	Power Input (kW)						
	Evaporating Temperature (°C)								Evaporating Temperature (°C)						
Model	-35	-30	-25	-20	-15	-10	-5	Model	-35	-30	-25	-20	-15	-10	-5
ZF06K4E	1.2	1.6	2.0	2.4	3.0	3.6	4.4	ZF06K4E	1.3	1.3	1.3	1.4	1.4	1.5	1.6
ZF08K4E	1.5	2.0	2.5	3.1	3.8	4.6	5.5	ZF08K4E	1.5	1.5	1.6	1.6	1.7	1.8	1.9
ZF09K4E	1.7	2.1	2.7	3.4	4.2	5.1	6.2	ZF09K4E	1.6	1.6	1.6	1.7	1.8	1.9	2.0
ZF11K4E	2.1	2.7	3.4	4.2	5.2	6.3	7.7	ZF11K4E	1.9	2.0	2.0	2.1	2.2	2.3	2.4
ZF13K4E	2.4	3.0	3.8	4.7	5.9	7.2	8.7	ZF13K4E	2.4	2.4	2.5	2.6	2.7	2.8	2.9
ZF15K4E	2.9	3.7	4.7	5.8	7.2	8.8	10.8	ZF15K4E	2.8	3.0	3.1	3.2	3.4	3.5	3.8
ZF18K4E	3.5	4.5	5.7	7.0	8.7	10.7	13.0	ZF18K4E	3.5	3.6	3.7	3.8	4.0	4.1	4.3
Models with Enhanced Vapor Injection															
ZF13KVE EVI	3.3	4.3	5.4	6.7	8.1	9.7	11.5	ZF13KVE EVI	2.8	2.9	3.0	3.0	3.1	3.2	3.3
ZF18KVE EVI	4.9	6.1	7.6	9.3	11.3	13.5	16.0	ZF18KVE EVI	3.8	4.0	4.1	4.2	4.4	4.5	4.7
ZF Summit Models - with Liquid Injection															
ZF25K5E	4.5	5.8	7.3	9.1	11.3	13.8	16.8	ZF25K5E	4.2	4.4	4.7	4.9	5.2	5.4	5.7
ZF34K5E	6.2	8.0	10.1	12.7	15.7	19.3	23.4	ZF34K5E	5.4	5.8	6.1	6.5	6.9	7.3	7.6
ZF41K5E	7.6	9.7	12.3	15.2	18.8	22.9	27.7	ZF41K5E	6.5	7.0	7.5	8.0	8.4	8.9	9.3
ZF49K5E	9.1	11.7	14.8	18.6	23.0	28.1	34.2	ZF49K5E	8.0	8.6	9.1	9.6	10.2	10.7	11.2
ZF54K5E	9.9	12.6	15.8	19.5	23.9			ZF54K5E	7.7	8.2	8.8	9.4	10.1		
ZF Summit Models - with Enhanced Vapor Injection															
ZF25K5E EVI	6.4	8.0	9.9	11.9	14.2	16.6	19.1	ZF25K5E EVI	4.5	4.7	4.9	5.1	5.3	5.5	5.8
ZF34K5E EVI	8.3	10.4	12.7	15.4	18.4	21.7	25.4	ZF34K5E EVI	5.6	5.8	6.0	6.2	6.4	6.6	6.8
ZF41K5E EVI	10.6	13.3	16.3	19.6	23.2	27.1	31.2	ZF41K5E EVI	7.0	7.3	7.5	7.7	8.0	8.2	8.4
ZF49K5E EVI	14.1	17.1	20.5	24.5	28.9			ZF49K5E EVI	9.1	9.7	10.3	10.8	11.3		

Suction Gas Return 20°C / Subcooling 0K
Preliminary Data

Capacity Data

Condensing Temperature 40°C															
Models with Liquid Injection															
R448A/ R449A	Cooling Capacity (kW)							R448A/ R449A	Power Input (kW)						
	Evaporating Temperature (°C)								Evaporating Temperature (°C)						
Model	-35	-30	-25	-20	-15	-10	-5	Model	-35	-30	-25	-20	-15	-10	-5
ZF06K4E	1.3	1.6	2.0	2.5	3.0	3.6	4.4	ZF06K4E	1.4	1.4	1.4	1.4	1.5	1.5	1.6
ZF08K4E	1.6	2.0	2.6	3.2	3.9	4.7	5.5	ZF08K4E	1.6	1.6	1.7	1.7	1.8	1.9	2.0
ZF09K4E	1.8	2.2	2.8	3.4	4.2	5.1	6.1	ZF09K4E	1.8	1.8	1.8	1.8	1.9	1.9	2.0
ZF11K4E	2.2	2.8	3.5	4.3	5.2	6.3	7.6	ZF11K4E	2.2	2.1	2.1	2.2	2.3	2.4	2.5
ZF13K4E	2.5	3.2	4.0	5.0	6.1	7.4	8.9	ZF13K4E	2.3	2.3	2.4	2.4	2.5	2.6	2.7
ZF15K4E	3.1	3.9	4.9	6.1	7.5	9.1	10.9	ZF15K4E	3.0	3.1	3.1	3.2	3.4	3.5	3.7
ZF18K4E	3.6	4.7	5.9	7.2	8.8	10.7	12.9	ZF18K4E	3.6	3.6	3.6	3.6	3.7	3.9	4.0
Models with Enhanced Vapor Injection															
ZF13KVE EVI	3.2	4.0	5.0	6.2	7.5	9.0	10.7	ZF13KVE EVI	2.5	2.6	2.7	2.8	2.8	2.9	3.0
ZF18KVE EVI	4.5	5.7	7.0	8.4	10.1	12.1	14.2	ZF18KVE EVI	3.1	3.3	3.6	3.8	4.0	4.2	4.3
ZF Summit Models - with Liquid Injection															
ZF25K5E	4.9	6.1	7.6	9.4	11.4	13.8	16.6	ZF25K5E	3.8	3.9	4.1	4.3	4.5	4.8	5.0
ZF34K5E	6.1	7.8	9.8	12.1	14.9	18.1	21.7	ZF34K5E	5.1	5.3	5.4	5.7	6.0	6.3	6.7
ZF41K5E	7.6	9.7	12.1	15.0	18.4	22.5	27.1	ZF41K5E	6.4	6.6	6.9	7.2	7.6	8.0	8.4
ZF49K5E	9.1	11.6	14.6	18.1	22.2	27.0	32.5	ZF49K5E	7.7	7.8	8.0	8.4	8.9	9.4	10.0
ZF54K5E	15.2	18.6	22.7	27.4	33.0			ZF54K5E	10.2	10.5	10.9	1.2	11.6		
ZF Summit Models - with Enhanced Vapor Injection															
ZF25K5E EVI	6.2	7.7	9.5	11.4	13.5	15.7	18.1	ZF25K5E EVI	3.9	4.2	4.5	4.8	5.1	5.3	5.5
ZF34K5E EVI	8.1	10.3	12.8	15.6	18.8	22.2	26.2	ZF34K5E EVI	5.6	6.0	6.4	6.8	7.3	7.9	8.5
ZF41K5E EVI	9.9	12.6	15.6	19.0	22.8	27.1	31.9	ZF41K5E EVI	6.8	7.3	7.8	8.4	9.0	9.7	10.4
ZF49K5E EVI	11.9	14.9	18.3	22.2	26.8			ZF49K5E EVI	8.4	8.9	9.4	10.0	10.6		

Suction Gas Return 20°C / Subcooling 0K
Preliminary Data

Capacity Data

Condensing Temperature 40°C															
Models with Liquid Injection															
R404A	Cooling Capacity (kW)							R404A	Power Input (kW)						
	Evaporating Temperature (°C)								Evaporating Temperature (°C)						
Model	-35	-30	-25	-20	-15	-10	-5	Model	-35	-30	-25	-20	-15	-10	-5
ZF06K4E	1.4	1.8	2.2	2.6	3.1	3.8	4.5	ZF06K4E	1.4	1.4	1.5	1.5	1.6	1.7	1.8
ZF08K4E	1.8	2.2	2.8	3.4	4.0	4.8	5.7	ZF08K4E	1.6	1.7	1.8	1.9	1.9	2.1	2.2
ZF09K4E	1.9	2.4	3.0	3.6	4.4	5.2	6.3	ZF09K4E	1.8	1.8	1.9	1.9	2.0	2.1	2.2
ZF11K4E	2.5	3.0	3.7	4.5	5.4	6.5	7.8	ZF11K4E	2.2	2.2	2.3	2.4	2.5	2.6	2.7
ZF13K4E	2.8	3.5	4.3	5.3	6.4	7.7	9.1	ZF13K4E	2.3	2.4	2.5	2.6	2.7	2.8	3.0
ZF15K4E	3.4	4.3	5.3	6.4	7.8	9.4	11.2	ZF15K4E	3.0	3.2	3.3	3.5	3.6	3.8	4.1
ZF18K4E	4.0	5.1	6.3	7.6	9.2	11.1	13.2	ZF18K4E	3.6	3.7	3.8	3.9	4.0	4.2	4.4
Models with Enhanced Vapor Injection															
ZF13KVE EVI	4.0	4.9	6.0	7.2	8.5	10.0	11.7	ZF13KVE EVI	2.8	2.9	3.0	3.0	3.1	3.2	3.3
ZF18KVE EVI	6.1	7.3	8.7	10.4	12.3	14.4	16.9	ZF18KVE EVI	3.8	4.0	4.1	4.2	4.4	4.5	4.7
ZF Summit Models - with Liquid Injection															
ZF25K5E	5.1	6.4	7.9	9.6	11.7	14.1	16.8	ZF25K5E	3.8	4.1	4.4	4.6	4.9	5.2	5.5
ZF34K5E	6.8	8.5	10.5	12.8	15.5	18.6	22.2	ZF34K5E	5.1	5.4	5.8	6.1	6.5	6.8	7.2
ZF41K5E	8.4	10.5	13.0	15.8	19.2	23.1	27.7	ZF41K5E	6.4	6.8	7.3	7.7	8.2	8.7	9.1
ZF49K5E	10.1	12.7	15.6	19.1	23.1	27.8	33.2	ZF49K5E	7.7	8.1	8.5	9.0	9.6	10.2	10.9
ZF54K5E	11.2	13.9	17.1	20.8	25.2			ZF54K5E	8.7	9.1	9.7	10.2	10.9		
ZF Summit Models - with Enhanced Vapor Injection															
ZF25K5E EVI	7.7	9.3	11.2	13.2	15.3	17.5	19.7	ZF25K5E EVI	4.8	5.1	5.4	5.7	6.0	6.3	5.8
ZF34K5E EVI	10.4	12.5	14.9	17.7	20.8	24.4	28.4	ZF34K5E EVI	6.4	6.8	7.2	7.6	7.9	8.3	6.8
ZF41K5E EVI	12.5	15.1	18.1	21.5	25.5	30.0	35.2	ZF41K5E EVI	7.9	8.3	8.8	9.2	9.7	10.1	8.4
ZF49K5E EVI	14.1	17.1	20.5	24.5	28.9			ZF49K5E EVI	9.1	9.7	10.3	10.8	11.3		

Suction Gas Return 20°C / Subcooling 0K
Preliminary Data

For capacity data of ZF28K5E please refer to Select Software.



ZFD & ZBD Copeland Scroll Digital™ Compressor Range for Medium and Low Temperature Refrigeration

Copeland Scroll Digital ZBD and ZFD compressors provide stepless continuous capacity modulation in medium and low temperature refrigeration applications.

Based on the unique Copeland Compliant Scroll™ design, the Digital modulation operates on a simple mechanism. Capacity control is achieved by separating the scroll sets axially over a small period of time. It is a simple mechanical solution allowing precise temperature control and system efficiency.

Digital Scroll technology is a simple modulation solution that can easily and quickly be implemented into any existing system design as no other components are required.

Digital Scroll technology provides continuous, stepless modulation from 10% to 100% with no operating envelope restriction. As a result, system pressures and temperatures are tightly controlled. These compressors provide optimum performance for refrigeration units, refrigeration packs, process and agricultural units.

The Digital Scroll range consists of:

- ZBD models dedicated to medium temperature applications
- ZFD models with vapor injection for low temperature applications
- ZOD model designed for use in R744 (CO₂) - see page 66



Copeland Scroll Digital for Low and Medium Temperature Refrigeration With and Without Sound Shell

CoreSense™ Diagnostics is now available as an option for the ZBD Scroll Summit series (ZBD76K5E and ZBD114K5E) as well as for ZFD41K5E.

These compressors are qualified for R407A/F/C, R448A/R449A and R404A for all digital models and R134a, R450A and R513 for ZBD only.

Digital Scroll Compressor Line-Up

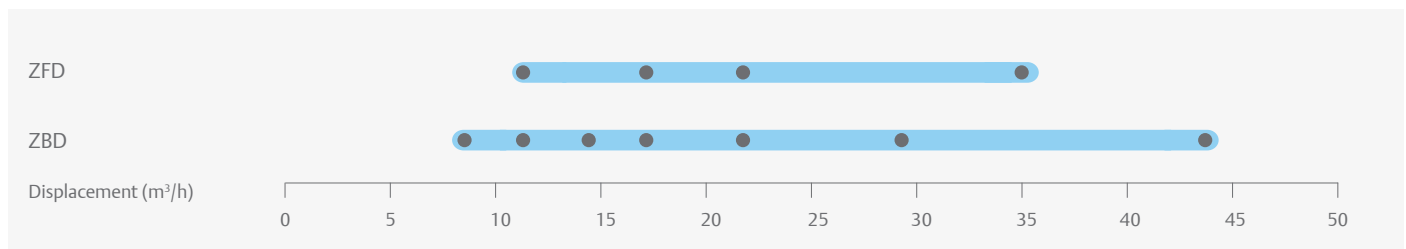

Features and Benefits

- Continuous modulation from 10% to 100% ensuring a perfect match of capacity and power to the desired load
- An economical and reliable alternative to variable speed drive
- Precise suction pressure control with associated energy savings
- Food quality is maintained by stable evaporating temperatures in the refrigerated areas
- Longer lasting refrigeration equipment due to fewer compressor cycling
- Quick and easy integration into refrigeration equipment, similar to any other scroll compressor
- Availability of optional sound shell on all models providing up to 10 dBA additional sound attenuation for silent operation
- Availability of Emerson's series of controllers that operate the Digital Scroll compressor
- Possibility of digital and liquid injection control via optional CoreSense technology

Maximum Allowable Pressure (PS)

- Digital ZBD:
Low Side PS 22.6 bar(g) / High Side PS 32 bar(g)
- Digital ZFD:
Low Side PS 22.6 bar(g) / High Side PS 32 bar(g)

Operating Envelope R448A/R449A

For ZBD Digital Models

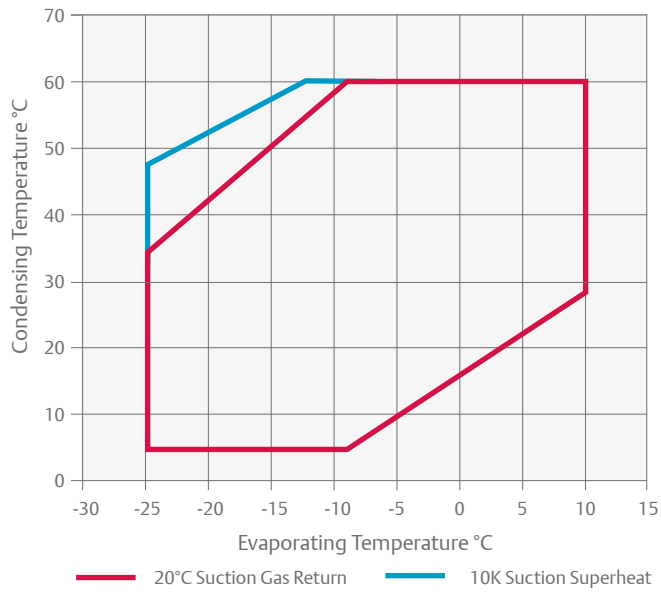

Operating Envelope R134a

For ZBD Digital Models

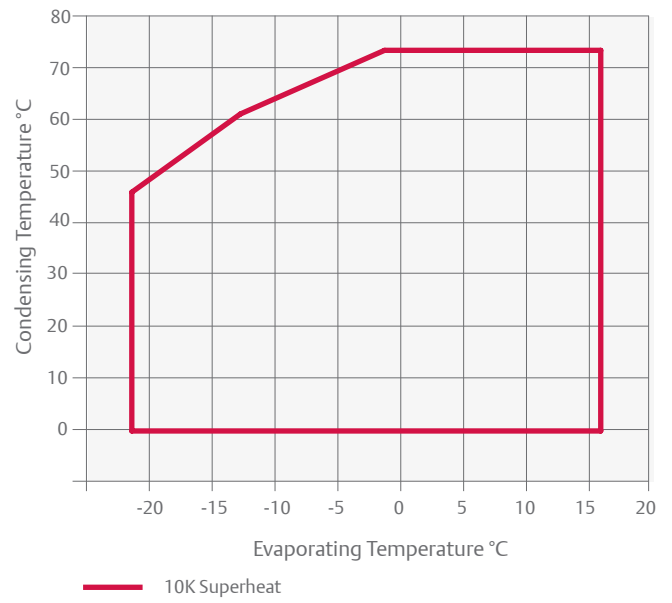

Operating Envelope R448A/R449A

For ZFD Digital Models

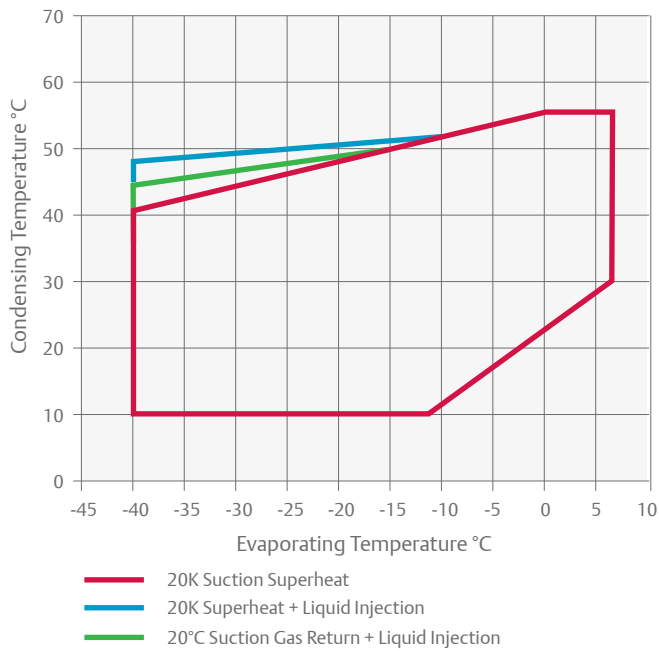

For individual model details please refer to select software.

Technical Overview

Models	Nominal hp	Displacement (m ³ /h)	Rotolock Suction (inch)	Rotolock Discharge (inch)	Oil Quantity (l)	Length/Width/Height (mm)	Net weight (kg)	Motor Version/Code		Maximum Operating Current (A)		Locked Rotor Current (A)		Sound Pressure @1 m - db(A)***
								1 Ph*	3 Ph**	1 Ph*	3 Ph**	1 Ph*	3 Ph**	
Medium Temperature														
ZBD21KCE	3.0	8.3	1 1/4	1	1.2	243/243/432	30.2	PFJ	TFD	16.5	6.7	97.0	40.0	62.0
ZBD29KCE	4.0	11.4	1 1/4	1	1.4	245/243/463	32.7		TFD		7.9		48.0	58.0
ZBD38KCE	5.0	14.4	1 1/4	1	1.9	246/250/481	38.1		TFD		11.3		64.0	67.0
ZBD45KCE	6.0	17.1	1 1/4	1	1.9	241/246/481	39.9		TFD		12.3		74.0	61.0
ZBD57KCE	7.5	21.4	1 1/4	1 1/4	1.9	246/257/481	43.1		TFD		15.9		102.0	68.0
ZBD76K5E	10.0	28.8	1 3/4	1 1/4	3.4	299/280/534	61.2		TFD		24.0		118.0	66.0
ZBD114K5E	15.0	43.3	1 3/4	1 1/4	3.4	299/280/552	68.9		TFD		33.0		174.0	71.0
Low Temperature														
ZFD13KVE EVI	4.0	11.7	1 1/4	1	1.9	246/250/481	38.6		TFD		9.0		64.0	65.0
ZFD18KVE EVI	6.0	17.1	1 1/4	1	1.9	300/299/481	43.1		TFD		13.8		74.0	67.0
ZFD25KVE EVI	7.5	21.4	1 1/4	1 1/4	1.9	246/250/481	43.1		TFD		16.0		102.0	70.0
ZFD41K5E	10.0	35.3	1 3/4	1 1/4	3.4	310/280/534	66.2		TFD		20.4		118.0	73.0
ZFD41K5E EVI	13.0	35.3	1 1/4	1 3/4	3.4	310/280/534	66.2		TFD		20.4		118.0	72.0

* 1ph: 230V/ 50Hz

** 3 Ph: 380-420V/ 50Hz

*** @ 1m: sound pressure level at 1m distance from the compressor, free field condition

For capacity data of ZFD54K5E please refer to select software.

Capacity Data

Condensing Temperature 40°C															
R407A	Cooling Capacity (kW)							R407A	Power Input (kW)						
	Evaporating Temperature (°C)								Evaporating Temperature (°C)						
Model	-35	-30	-25	-20	-15	-10	-5	Model	-35	-30	-25	-20	-15	-10	-5
Medium Temperature															
ZBD21KCE				3.4*	4.3	5.2	6.3	ZBD21KCE				1.8*	1.9	1.9	2.0
ZBD29KCE				4.2*	5.5	6.8	8.4	ZBD29KCE				2.6*	2.6	2.6	2.6
ZBD38KCE				5.5*	7.3	9.1	11.2	ZBD38KCE				3.4*	3.4	3.4	3.5
ZBD45KCE				6.1*	8.1	10.1	12.5	ZBD45KCE				3.8*	3.8	3.8	3.9
ZBD57KCE				8.4*	11.1	13.8	17.0	ZBD57KCE				5.2*	5.2	5.3	5.3
ZBD76K5E			8.2*	11.3	14.5	18.4	22.8	ZBD76K5E			7.5*	7.1	7.1	7.3	7.5
ZBD114K5E			10.8*	15.6	20.5	26.3	32.8	ZBD114K5E			10.3*	10.2	10.2	10.3	10.5
Low Temperature with Enhanced Vapor Injection															
ZFD13KVE EVI	3.1	4.1	5.2	6.4	7.7	9.2	10.9	ZFD13KVE EVI	2.7	2.8	2.8	2.9	2.9	3.0	3.1
ZFD18KVE EVI	4.9	6.0	7.3	8.8	10.8	13.3	16.4	ZFD18KVE EVI	3.4	3.5	3.6	3.7	3.9	4.1	4.4
ZFD25KVE EVI	6.1	7.7	9.4	11.4	13.5	15.8	18.2	ZFD25KVE EVI	4.3	4.4	4.6	4.8	5.0	5.3	5.5
ZFD41K5E	7.3	9.3	11.8	14.6				ZFD41K5E	6.2	6.7	7.2	7.5			
ZFD41K5E EVI	10.1	12.6	15.5	18.7	22.1	25.8	23.7	ZFD41K5E EVI	6.7	6.9	7.2	7.4	7.6	7.8	8.0

Suction Gas Return 20°C / Subcooling 0K

*Suction Superheat 10K, Subcooling 0K

Preliminary Data

Condensing Temperature 40°C															
R407F	Cooling Capacity (kW)							R407F	Power Input (kW)						
	Evaporating Temperature (°C)								Evaporating Temperature (°C)						
Model	-35	-30	-25	-20	-15	-10	-5	Model	-35	-30	-25	-20	-15	-10	-5
Medium Temperature															
ZBD21KCE						5.1	6.3	ZBD21KCE						2.0	2.0
ZBD29KCE					5.8*	7.3	8.9	ZBD29KCE					2.9*	2.9	2.9
ZBD38KCE				5.7*	7.1*	8.9	10.8	ZBD38KCE			3.0*	3.3*	3.5	3.6	
ZBD45KCE				6.4*	8.4*	10.8	13.2	ZBD45KCE			3.7*	3.9*	4.1	4.3	
ZBD57KCE				8.5*	10.8*	13.8	17.0	ZBD57KCE			5.2*	5.2*	5.3	5.3	
ZBD76K5E				11.5*	15.2	19.3	23.9	ZBD76K5E			7.5*	7.4	7.6	7.9	
ZBD114K5E				15.8*	21.5	27.6	34.4	ZBD114K5E			10.7*	10.7	10.8	11.0	
Low Temperature with Enhanced Vapor Injection															
ZFD13KVE EVI	3.3	4.3	5.4	6.7	8.1	9.7	11.4	ZFD13KVE EVI	2.8	2.9	3.0	3.0	3.1	3.1	3.2
ZFD18KVE EVI	4.9	6.1	7.6	9.3	11.3	13.5	16.0	ZFD18KVE EVI	3.8	4.0	4.1	4.2	4.4	4.5	4.7
ZFD25KVE EVI	6.4	8.0	9.9	11.9	14.2	16.6	19.1	ZFD25KVE EVI	4.5	4.7	4.9	5.1	5.3	5.5	5.8
ZFD41K5E	7.3	9.3	11.8	14.6				ZFD41K5E	6.2	6.7	7.2	7.5			
ZFD41K5E EVI	23.5	29.8	37.2	45.9				ZFD41K5E KVE	6.4	6.6	6.8	7.1			

Suction Gas Return 20°C / Subcooling 0K

*Suction Superheat 10K, Subcooling 0K

Preliminary Data

Capacity Data

Condensing Temperature 40°C															
R448A/ R449A	Cooling Capacity (kW)							R448A/ R449A	Power Input (kW)						
	Evaporating Temperature (°C)								Evaporating Temperature (°C)						
Model	-35	-30	-25	-20	-15	-10	-5	Model	-35	-30	-25	-20	-15	-10	-5
Medium temperature															
ZBD21KCE			2.5*	3.3	4.2	5.2	6.4	ZBD21KCE			2.0*	2.0	2.0	2.0	2.0
ZBD38KCE			3.9*	5.7	7.2	8.9	10.9	ZBD38KCE			3.4*	3.4	3.4	3.4	3.4
ZBD45KCE			4.5*	6.6	8.4	10.5	12.8	ZBD45KCE			3.9*	3.9	3.9	3.9	3.9
ZBD57KCE			6.0*	8.7	11.0	13.6	16.5	ZBD57KCE			4.3*	4.5	4.7	4.9	5.1
ZBD76K5E					15.1	18.8	23.0	ZBD76K5E					6.9	6.9	7.0
ZBD114K5E					21.8	27.7	34.2	ZBD114K5E					10.7	10.8	10.9
Low Temperature with Enhanced Vapor Injection															
ZFD13KVE EVI	3.3	4.2	5.2	6.3	7.6	9.0	10.6	ZFD13KVE EVI	2.3	2.3	2.4	2.5	2.7	2.8	2.8
ZFD18KVE EVI	4.8	6.0	7.4	9.0	10.8	12.9	15.2	ZFD18KVE EVI	3.4	3.6	3.8	4.0	4.3	4.5	4.7
ZFD25KVE EVI	6.2	7.7	9.5	11.4	13.5	15.7	18.1	ZFD25KVE EVI	3.9	4.2	4.5	4.8	5.1	5.3	5.5
ZFD41K5E	7.4	9.4	11.8	14.6	17.9	21.7	26.2	ZFD41K5E	5.4	5.8	6.2	6.8	7.4	8.1	8.9
ZFD41K5E EVI	9.9	12.5	15.6	19.0	22.8	27.9	31.9	ZFD41K5E EVI	6.8	7.3	7.8	8.4	9.0	9.7	10.4

Suction Gas Return 20°C / Subcooling 0K

*Suction Superheat 10K, Subcooling 0K

Preliminary Data

Condensing Temperature 40°C															
R404A	Cooling Capacity (kW)							R404A	Power Input (kW)						
	Evaporating Temperature (°C)								Evaporating Temperature (°C)						
Model	-35	-30	-25	-20	-15	-10	-5	Model	-35	-30	-25	-20	-15	-10	-5
Medium Temperature															
ZBD21KCE			3.0	3.7	4.5	5.5	6.6	ZBD21KCE			1.9	1.9	2.0	2.1	2.1
ZBD29KCE			4.1	5.1	6.2	7.4	8.9	ZBD29KCE			2.5	2.6	2.7	2.8	2.8
ZBD38KCE			5.2	6.3	7.7	9.3	11.1	ZBD38KCE			3.1	3.2	3.4	3.5	3.6
ZBD45KCE			6.1	7.5	9.2	11.2	13.4	ZBD45KCE			3.7	3.8	4.0	4.2	4.4
ZBD57KCE			7.9	9.7	11.9	14.3	17.1	ZBD57KCE			4.7	4.9	5.2	5.4	5.5
ZBD76K5E			10.6	13.3	16.4	20.0	23.9	ZBD76K5E			7.5	7.5	7.6	7.7	7.8
ZBD114K5E			14.2	18.6	23.4	28.7	34.7	ZBD114K5E			11.3	11.3	11.3	11.4	11.4
Low Temperature with Enhanced Vapor Injection															
ZFD13KVE EVI	4.0	4.9	6.0	7.2	8.5	10.0	11.7	ZFD13KVE EVI	2.9	3.0	3.1	3.2	3.3	3.4	3.5
ZFD18KVE EVI	6.1	7.3	8.7	10.4	12.3	14.4	16.9	ZFD18KVE EVI	4.0	4.3	4.5	4.6	4.8	5.0	5.1
ZFD25KVE EVI	7.7	9.3	11.2	13.2	15.3	17.5	19.7	ZFD25KVE EVI	4.8	5.1	5.4	5.7	6.0	6.3	6.6
ZFD41K5E EVI	12.5	15.0	18.1	21.5	25.4	29.5	33.9	ZFD41K5E EVI	7.9	8.4	8.8	9.3	9.7	10.1	10.6
ZFD41K5E	8.6	10.6	13.0	15.7	18.9	22.6	27.0	ZFD41K5E	6.3	6.7	7.1	7.5	7.9	8.4	8.8

Suction Gas Return 20°C / Subcooling 0K

Preliminary Data

Capacity Data

Condensing Temperature 40°C																	
R134a		Cooling Capacity (kW)						R134a		Power Input (kW)							
		Evaporating Temperature (°C)								Evaporating Temperature (°C)							
Model		-35	-30	-25	-20	-15	-10	-5	Model		-35	-30	-25	-20	-15	-10	-5
Medium Temperature																	
ZBD21KCE					2.0*	2.7	3.3	4.0	ZBD21KCE					1.2*	1.3	1.4	1.4
ZBD29KCE					2.5*	3.3	4.2	5.2	ZBD29KCE					1.7*	1.7	1.7	1.7
ZBD38KCE					3.2*	4.4	5.5	6.8	ZBD38KCE					1.9*	2.1	2.2	2.3
ZBD45KCE					3.8*	5.1	6.4	7.9	ZBD45KCE					2.3*	2.4	2.5	2.6
ZBD57KCE					4.7*	6.4	8.1	10.1	ZBD57KCE					3.4*	3.4	3.4	3.5
ZBD76K5E*					6.2	7.9	10.0	12.6	ZBD76K5E					5.3	5.3	5.4	5.4
ZBD114K5E*					8.1	11.1	14.6	18.7	ZBD114K5E					7.4	7.4	7.4	7.5

Suction Gas Return 20°C / Subcooling 0K

*Suction Superheat 10K, Subcooling 0K

Preliminary Data

Emerson Coresense™ Diagnostics for Refrigeration Scrolls

The CoreSense Diagnostics module is a breakthrough innovation for troubleshooting refrigeration system faults and is installed in the electrical box of all 8 - 17 hp Copeland Scroll K5 refrigeration compressors. By monitoring and analyzing data from the compressors (via module power, discharge line thermistor and the current transducer), the CoreSense module accurately detects the cause of electrical and system related issues and guides the service technician more quickly and accurately to the root cause of a problem via flashing LED indicators visible on the CoreSense box. Supermarket operators hence benefit from increased system uptime as well as reduced food losses and maintenance costs.



Coresense™ Diagnostics for Refrigeration Scrolls



Technical Specification

- Power supply 110-230V AC
- Front end: multi-color LEDs
- Communication protocol: Modbus®RTU
- Bus to system controller: RS485, 3-wire, (+,GND)
- Discharge temperature sensor
- Current sensor
- EEPROM memory
- Alarm reset button

Benefits

- Facilitate predictive maintenance & advanced diagnostics
- Reduce applied system costs
- Manage on-site compressor data
- Reduce maintenance costs
- Increase system uptime / reduce food loss
- Digital and liquid injection control through CoreSense
- Remote trouble shooting

Functions

- Current sensing based diagnostics
- Discharge temperature protection
- Phase monitor protection
- Liquid injection control
- Scroll Digital control
- Open circuit identification
- System trip protection
- Low voltage protection
- Locked rotor protection
- Alarm and operating history
- Asset information
- LED visual indication of alerts
- Modbus communication



ZO & ZOD Copeland Scroll™ Compressor Ranges for R744-Subcritical Refrigeration

ZO Copeland Scroll Compressors have been designed for use in R744 (CO₂) low temperature refrigeration systems. These compressors are suitable for usage in CO₂-subcritical cascade and booster systems.

Increasing environmental concerns about potential direct emissions from HFC-based refrigeration systems into the atmosphere have led to the revival of R744 in the European refrigeration market. Regionally, this trend is reinforced by legislation and taxation schemes which favor the usage of refrigerant R744.

In comparison with HFC refrigerants, the specific properties of R744 require changes in the design of the refrigeration system. The ZO range of Copeland Scroll compressors has been particularly designed to exploit the characteristics of the R744 refrigeration system. Efficiency, reliability and liquid handling advantages of the Copeland Scroll technology equally apply.

The optimized design of ZO compressors effectively address the challenges of R744 systems i.e., high pressure levels, higher mass flow for a given displacement while securing proper lubrication.

The range consists of 6 models including 2 digital models for 10 to 100% continuous cooling capacity modulation.



ZO Compressor for Low Temperature Refrigeration

ZO and ZOD Compressor Line-up

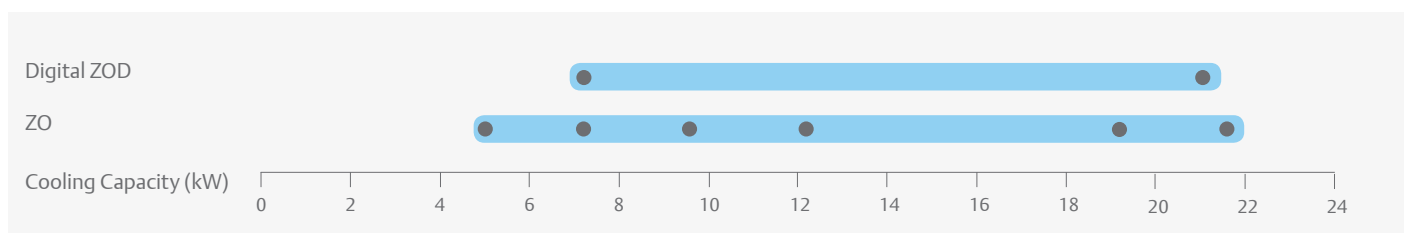

Conditions EN12900 R744: Evaporating -35°C, Refrigeration -5°C, Suction Superheat 10K, subcooling 0K

Features and Benefits

- Optimized for high efficiency in CO₂-subcritical cascade and booster systems
- High condensing temperature limit allowing for optimized overall system design
- Compact design minimizing required machine room space
- Half the weight of equivalent semi-hermetic compressors
- Optional Sound Shell allowing 10 dBA sound attenuation
- High bearing reliability and lubrication of all critical parts under all conditions including liquid slugging
- Availability of a digital model offering simple, stepless 10 to 100% capacity modulation

Maximum Allowable Pressure (PS)

- ZO: Low Side PS 30 bar(g) / High Side PS 52 bar(g)
- Digital ZOD: Low Side PS 30 bar(g) / High Side PS 45 bar(g)

Operating Envelope R744

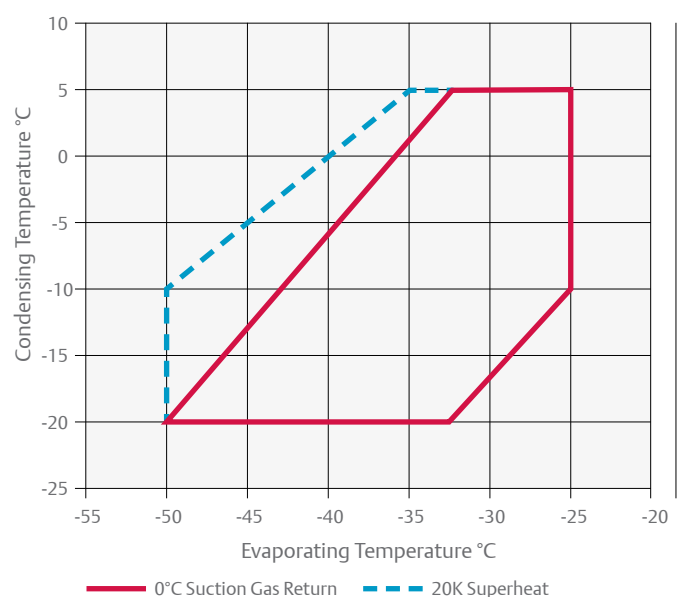

For individual model details please refer to Select Software.

Technical Overview

Models	Nominal hp	Displacement (m ³ /h)	Stub Suction (inch)	Stub Discharge (inch)	Oil Quantity (l)	Length/Width/height (mm)	Net Weight (kg)	Motor Version/ Code	Maximum Operating Current (A)	Locked Rotor Current (A)	Sound Pressure @1 m - dB(A)***
								3 Ph**	3 Ph**	3 Ph**	
ZO21K5E	1.5	2.6	11/4	1	1.0	228/228/388	22.2	TFD	3.6	27	52
ZO34K3E	2	4.1	11/4	1	1.4	242/242/381	30	TFD	5.5	26	54
ZO45K3E	2.5	5.4	11/4	1	1.4	242/242/403	31	TFD	6.2	35	56
ZO58K3E	3.5	6.9	11/4	1	1.4	242/242/417	32.5	TFD	8	48	56
ZO88KCE	5	10.1	11/4	1	1.9	245/249/440	40.3	TFD	11.8	64	60
ZO104KCE	6	11.7	11/4	1	1.9	242/242/461	40	TFD	15	74	61
Digital Models											
ZOD34K3E	2	4.07	11/4	1	1.4	242/242/377	30	TFD	5.5	26	55
ZOD104KCE	6	11.7	11/4	1	1.9	241/246/484	41	TFD	15	75	67

Capacity Data

Condensing Temperature: -10°C									
R744	Cooling Capacity (kW)				R744	Power Input (kW)			
	Evaporating Temperature (°C)					Evaporating Temperature (°C)			
Model	-45	-40	-35	-30	Model	-45	-40	-35	-30
ZO21K5E	3.2	4.1	5.1	6.2	ZO21K5E	1.2	1.2	1.2	1.1
ZO34K3E	4.8	6.2	7.8	9.7	ZO34K3E	1.8	1.8	1.8	1.7
ZO45K3E	7.0	8.8	10.9	13.3	ZO45K3E	2.3	2.3	2.3	2.2
ZO58K3E	8.9	11.2	13.9	17.0	ZO58K3E	3.0	3.0	2.9	2.8
ZO88KCE	13.3	17.0	21.0	25.4	ZO88KCE	4.5	4.5	4.4	4.2
ZO104KCE	15.9	19.7	24.1	29.2	ZO104KCE	4.9	5.0	5.1	5.2
Digital Models									
ZOD34K3E	5.1	6.4	7.9	9.7	ZOD34K3E	1.8	1.8	1.8	1.7
ZOD104KCE	15.6	19.1	23.2	27.9	ZOD104KCE	5.0	5.0	5.1	5.3

10 K Superheat
Preliminary Data

Sound Shell for Copeland Scroll™ Compressors Quiet Operation in Sound Critical Environment

Environmental noise has become a serious problem that can lead to potential contentious situations. It is particularly true for refrigeration applications where kitchen equipment or compressor packs are often source of disturbing noise in domestic areas. Emerson put sound minimisation at the centre of any of its new compressor development along reliability, seasonal efficiency, size and weight reduction.

A large portion of equipment acoustic emissions come from condensers and compressors and in some critical sound sensitive applications the refrigeration installations need to be acoustically insulated. Simple solutions are now available to contain sound emissions. Emerson Climate Technologies has developed a dedicated Sound Shell for all Copeland Scroll compressors from

2–15 hp. It completely encapsulates the compressor, minimizing sound leaks while cooling performance remains uncompromised.

Groundbreaking design techniques and materials, derived from the automotive industry, were utilized to design the Sound Shell. The use of low pressure reaction injection moulded parts (top cap cover, terminal box cover and compressor base plate) allows a 10–12 dBA sound attenuation.

It is a significant improvement over conventional sound jackets available from other suppliers that reduce sound by 3–6 dBA depending on the application. Particular attention was also paid in the design stage to ensure ease of mounting in retrofit, service and new installation situations.

Sound Shell for Copeland Scroll



Technical Overview

	Small Scroll	Summit Scroll			Summit Digital Scroll	
	All Sizes	Small Size	Medium Size	Large Size	Small Size	Medium Size
Technical Data						
Sound Attenuation	10 - 12 dBA					
Total weight (kg)	3.4	4.8	4.9	5.1	5.3	5.6
Mantle thickness	25mm					
Flammability	Conforms to IEC 60335-1 §30					
Material						
Mantle	Green felt layer (cotton + binder 1.2 kg/m ²)					
	Heavy layer (PVC 4.5 kg/m ²)					
	Closure by use of Velcro fastening - High frequency welded on PVC layer					
Base Plate	PU SRIM - Low pressure reaction injection moulding technology					
Top cap cover	PU SRIM - Low pressure reaction injection moulding technology					
	Inside insulation green felt and aluminium film					
	High temperature insulation ring					
Terminal box cover	PU SRIM - Low pressure reaction injection moulding technology					





Semi-Hermetic Reciprocating Compressors

Emerson offers different ranges of semi-hermetic reciprocating compressors with distinct levels of performance and technical characteristics depending on the application requirements.

The Stream Series:

Emerson has introduced Stream, a line of semi-hermetic 4 and 6 cylinder compressors. The series provides best in class performance for today's HFC-based and uprising natural and low GWP refrigerants, significantly reducing cost of operation and environmental impact compared to competing products.

The range consists of 4 and 6 cylinder models, available with both inverter and continuous capacity modulation options. The compressors can be fitted with a dedicated sound shell for sound sensitive applications.

The new Emerson line-up of 4 cylinder compressors for CO₂-transcritical applications is the ideal solution for R744 medium temperature cascade and booster systems. It is characterised by a design pressure of 135 bar. Refrigerant flow and heat transfer have been optimized for best performance. In combination with the CO₂-subcritical scroll for the low temperature refrigeration side, Emerson offers the most energy efficient package available on the market today.

With advanced protection and diagnostics features for system reliability, reduced service costs and increased equipment uptime, the Stream series is built to last in today's modern and changing world.



Stream 4 Cylinder



Stream 6 Cylinder



Stream 4 Cylinder for R744



Stream Digital 4 Cylinder



Stream Digital 6 Cylinder



Sound Shell for Stream



The S-Series:

Its design is based on traditional “reed” valve plates similar to what is used in reciprocating compressors offered by other manufacturers. The performance of such compressors meets basic market requirements but cannot compete with Discus compressors in terms of efficiency. The S-Series ranges from 1.5 to 70 hp and is composed of K and L presented in this catalogue.



S-Series

The Discus Range:

It is broadly recognized as the most efficient compressor whatever the running condition. This range is mainly used in medium and low temperature refrigeration applications where system efficiency is a priority for the end-user. The key difference between Discus and other reciprocating compressors lies in its valve plate design. Traditional “reed” valves are replaced by ‘puck” type valves that are integrated in the valve plate. This special design eliminates the dead volume at the end of the compression and allows for the highest compressor efficiency. To date, no other reciprocating compressor is able to match Discus in terms of performance. Available from 4 to 60 hp, they are referred to as 2D, 3D and 8D in this catalogue.



Discus 2 Cylinder

Emerson CoreSense™ Diagnostics for Copeland™ Stream Refrigeration Compressors

Emerson CoreSense Diagnostics is an innovative technology for Copeland Stream refrigeration compressors. It goes beyond compressor protection by assisting in system diagnosis and optimization. Providing service engineers with detailed information at the right time, system-related problems can be diagnosed faster or even before they occur. Supermarket operators benefit from increased system uptime, reduction in food loss and reduced maintenance costs.



Emerson CoreSense Diagnostics for Copeland™ Stream refrigeration compressors. ensuring best performance over full lifetime.

Technical Specification

- Power supply 120/240V AC, 24V AC
- Front end: 2 x LED, green/red, yellow
- Communication protocol (Modbus®RTU)
- Bus to system controller: RS 485, 3-wire, (+, GND, -)
- Discharge temperature sensor
- Current sensor and sensor module
- Flash memory
- Alarm reset button
- IP 54

Benefits

- Reduce applied system costs
- Manage on-site compressor data
- Facilitate predictive maintenance & advanced diagnostics
- Reduce maintenance costs
- Increase system uptime / reduce food loss
- Power consumption monitoring

Functions

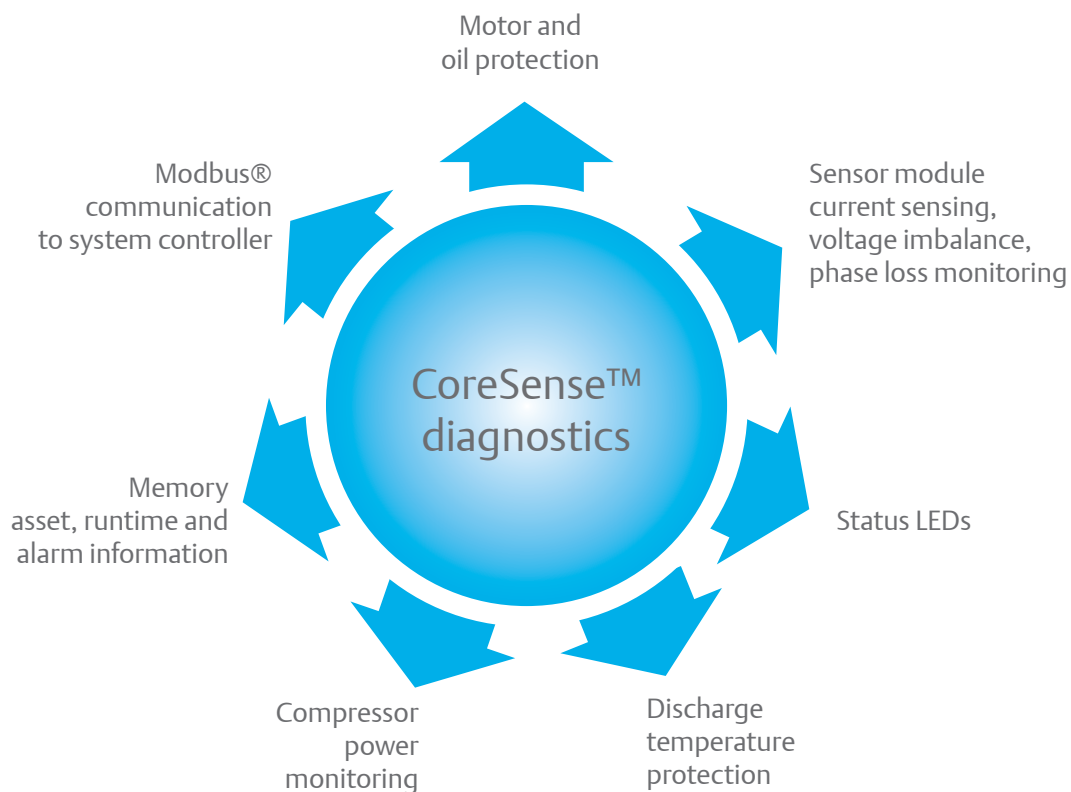



Scope of Supply

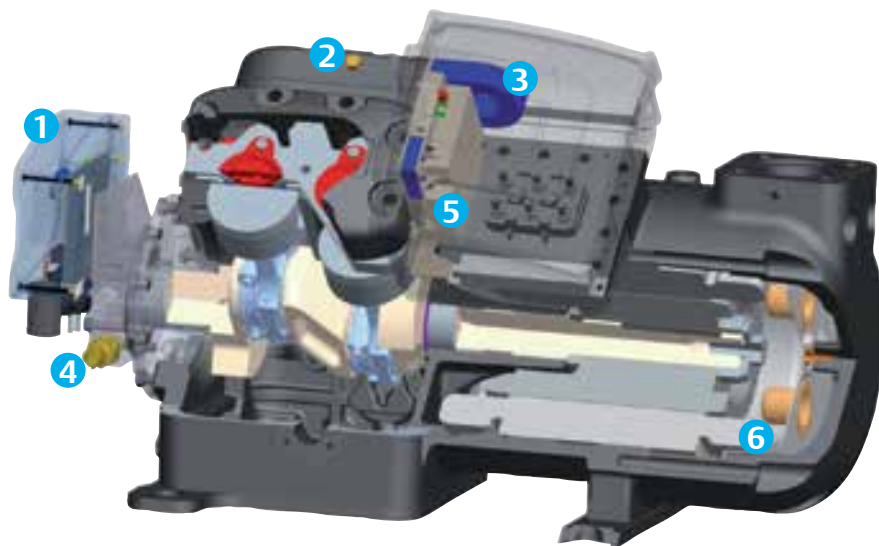

1 CoreSense™ Diagnostics Control Module

2 Discharge Temperature Sensor

3 Current Sensor

4 Oil Pressure Sensor

5 Sensor Module

6 Motor Temperature Sensor

K and L Reciprocating Compressor Range

Small 2-cylinder semi-hermetic reciprocating compressors for medium and low temperature refrigeration applications and transport refrigeration.

Designed on the principle of standard reed valve type technology, these compressors feature an internal oil pump that guarantees optimum reliability in all operating conditions.

The K-series ranges from 0.5 to 2 hp and the L-series from 2 to 5 hp with a displacement of 4 to 22.5 m³/h.

These compressors are qualified for R407A/F/C, R448A/R449A, R404A and R134a.



K-Series Compressor

K & L Compressor Line-Up

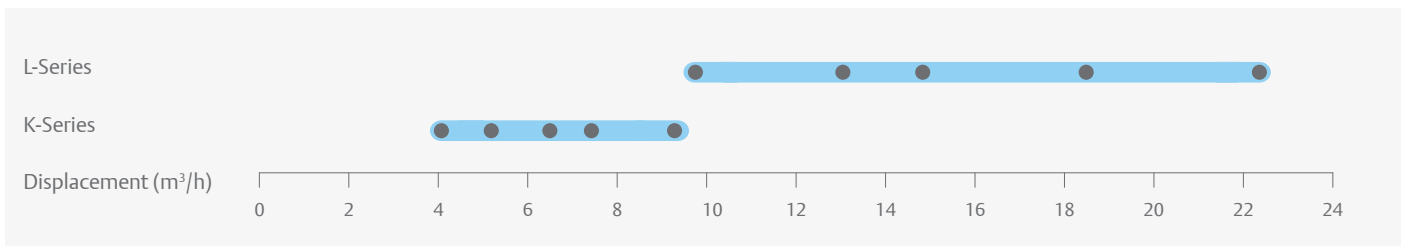

Features and Benefits

- Large operating envelope from 5°C to -45°C evaporating and up to 55°C condensing
- Two motor sizes per displacement, optimized for different applications
- Compact and light compressors
- Ideal for refrigeration unit or transport applications
- Integrated oil pump for maximum reliability

Maximum Allowable Pressure (PS)

- Low Side PS 22.5 bar (g) / High Side PS 28 bar (g)

Operating Envelope R404A

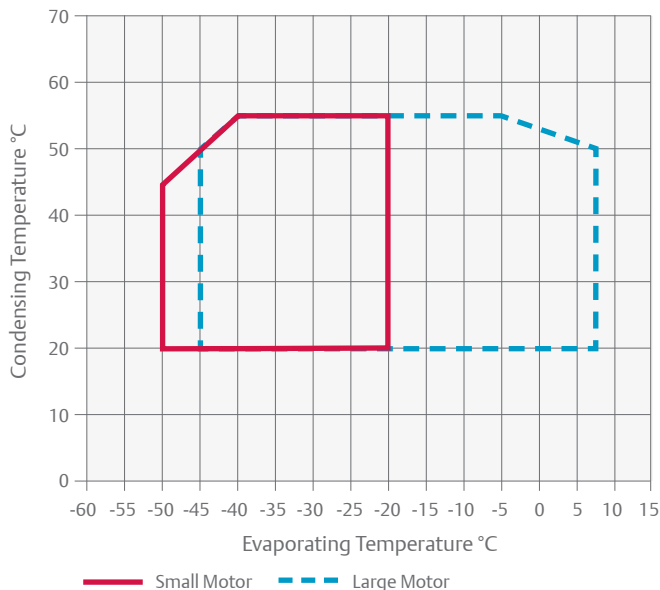

Operating Envelope R134a

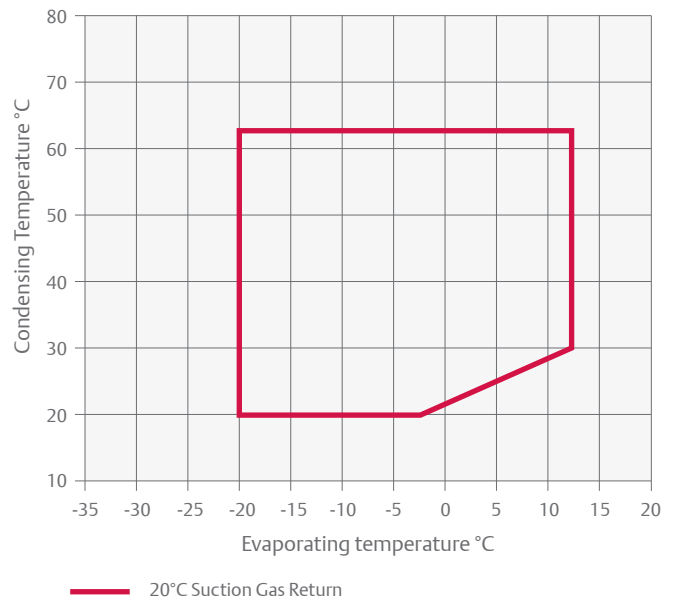

For individual model details please refer to select software.

Operating Envelope R448A/R449A

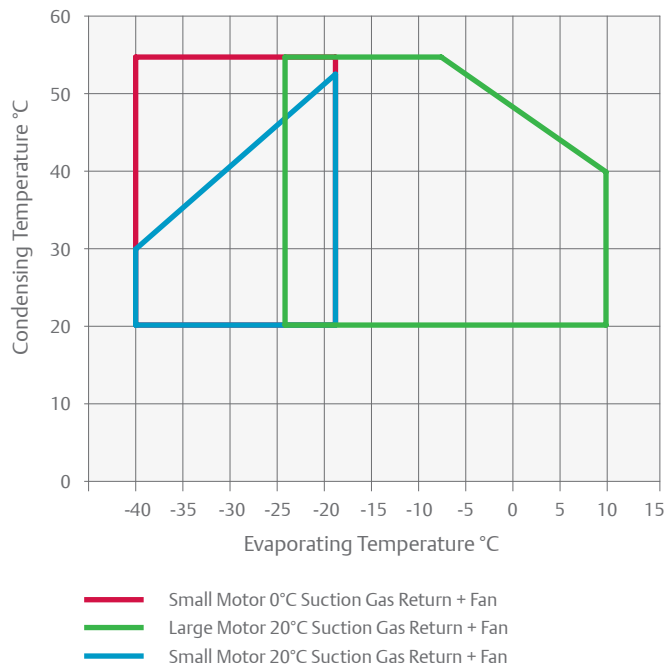

Technical Overview

Models	Nominal hp	Displacement (m ³ /h)	Oil quantity (l)	Length/Width/Height (mm)	Net Weight (kg)	Motor Version/ Code		Maximum Operating Current (A)		Locked Rotor Current (A)		Sound Pressure @1 m - dB(A) ***
						1 Ph*	3 Ph**	1 Ph*	3 Ph**	1 Ph*	3 Ph**	
KM-5X	0.5	4.0	0.7	365/235/280	39.0	CAG	EWL	4.8	1.8	24.0	12.2	45.0
KM-7X	0.8	4.0	0.7	365/235/280	39.0	CAG	EWL	6.0	2.4	34.5	12.2	45.0
KJ-7X	0.8	5.1	0.7	365/235/280	39.0	CAG	EWL	5.8	2.3	34.5	12.2	45.0
KJ-10X	1.0	5.1	0.7	365/235/280	39.0	CAG	EWL	7.1	3.2	32.4	15.5	45.0
KSJ-10X	1.0	6.3	0.7	365/235/280	40.0	CAG	EWL	6.7	2.7	32.4	15.5	50.0
KSJ-15X	1.5	6.3	0.7	365/235/280	40.0	CAG	EWL	9.0	3.4	43.0	19.1	53.0
KL-15X	1.5	7.4	0.7	365/235/280	39.0	CAG	EWL	8.4	3.4	43.0	19.1	47.0
KL-20X	2.0	7.4	0.7	365/235/280	39.0		EWL		3.8		20.4	
KSL-20X	2.0	9.1	0.7	365/235/280	40.0		EWL		4.7		20.4	
LE-20X	2.0	9.9	2.0	470/330/385	78.0		EWL		5.7		37.6	51.0
LF-20X	2.0	12.9	2.0	470/330/385	80.0		EWL		5.5		37.6	51.0
LF-30X	3.0	12.9	2.0	470/330/385	80.0		EWL		7.2		53.0	51.0
LJ-20X	2.0	14.5	2.0	470/330/385	78.0		EWL		5.6		37.6	52.0
LJ-30X	3.0	14.5	2.0	470/330/385	83.0		EWL		8.1		53.0	52.0
LL-30X	3.0	18.2	2.0	470/330/385	85.0		EWL		7.3		50.6	52.0
LL-40X	4.0	18.2	2.0	470/330/385	87.0		EWL		9.5		58.9	63.0
LSG-40X	4.0	22.5	2.0	470/330/385	77.0		EWL		8.9		58.9	63.0

* 1 Ph: 230V/ 50Hz

** 3 Ph: 380-420V/ 50Hz

*** @ 1m: sound pressure level at 1m distance from the compressor, free field condition

Capacity Data

Condensing Temperature: 40°C															
R404A	Cooling Capacity (kW)							R404A	Power Input (kW)						
	Evaporating Temperature (°C)								Evaporating Temperature (°C)						
Model	-45	-35	-30	-20	-10	-5	+5	Model	-45	-35	-30	-20	-10	-5	+5
KM-5X	0.2°	0.6°	0.8°	1.3°				KM-5X	0.3°	0.5°	0.6°	0.7°			
KM-7X	0.2°	0.5°	0.8°	1.3°	2.0°	2.5°	3.6°	KM-7X	0.3°	0.5°	0.6°	0.8°	0.9°	1.0°	1.0°
KJ-7X	0.4°	0.8°	1.1°	1.8°				KJ-7X	0.5°	0.7°	0.8°	1.0°			
KJ-10X	0.3°	0.8°	1.0°	1.8°	2.8°	3.4°	4.9°	KJ-10X	0.4°	0.7°	0.8°	1.0°	1.2°	1.3°	1.4°
KSJ-10X	0.5°	1.0°	1.4°	2.3°				KSJ-10X	0.7°	0.9°	1.1°	1.3°			
KSJ-15X	0.5°	1.0°	1.4°	2.3°	3.5°	4.2°	6.1°	KSJ-15X	0.6°	0.9°	1.0°	1.3°	1.6°	1.7°	1.8°
KL-15X	0.6°	1.2°	1.6°	2.6°				KL-15X	0.8°	1.0°	1.2°	1.5°			
KL-20X	0.5°	1.1°	1.5°	2.6°	4.1°	5.0°		KL-20X	0.6°	0.9°	1.1°	1.4°	1.7°	1.8°	
KSL-20X	0.8°	1.5°	2.0°	3.3°	5.1°	6.1°		KSL-20X	0.8°	1.2°	1.4°	1.9°	2.3°	2.5°	
LE-20X		1.1°	1.7°	3.2°	5.1°	6.4°	9.4°	LE-20X		1.0°	1.2°	1.6°	2.0°	2.2°	2.5°
LF-20X		1.8°	2.3°	4.0°				LF-20X		1.4°	1.7°	2.2°			
LF-30X	0.7°	1.9°	2.6°	4.6°	7.2°	8.8°	12.8°	LF-30X	1.0°	1.6°	1.9°	2.4°	2.9°	3.1°	3.4°
LJ-20X		1.9°	2.8°	5.0°				LJ-20X		1.6°	1.9°	2.6°			
LJ-30X	0.8°	2.1°	2.9°	5.1°	8.0°	9.8°	14.2°	LJ-30X	1.1°	1.8°	2.1°	2.8°	3.3°	3.6°	3.9°
LL-30X	0.9°	2.6°	3.7°	6.5°				LL-30X	1.1°	2.0°	2.4°	3.3°			
LL-40X	1.1°	2.7°	3.7°	6.4°	10.2°	12.6°	18.4°	LL-40X	1.4°	2.2°	2.6°	3.3°	4.0°	4.3°	4.9°
LSG-40X	1.4°	3.5°	4.8°	8.2°				LSG-40X	1.6°	2.6°	3.1°	4.1°			

Suction Gas Return 20°C / Subcooling 0K

* High Discharge Temp - Additional Cooling Required

Condensing Temperature: 40°C															
R134a	Cooling Capacity (kW)							R134a	Power Input (kW)						
	Evaporating Temperature (°C)								Evaporating Temperature (°C)						
Model	-45	-35	-30	-20	-10	-5	+5	Model	-45	-35	-30	-20	-10	-5	+5
KM-5X				0.7°	1.2°	1.5°	2.3°	KM-5X				0.5°	0.6°	0.6°	0.7°
KJ-7X				0.9°	1.6°	2.0°	3.0°	KJ-7X				0.6°	0.7°	0.8°	0.8°
KSJ-10X				1.2°	2.0°	2.5°	3.8°	KSJ-10X				0.7°	0.8°	0.9°	1.0°
KL-15X				1.4°	2.2°	2.8°	4.3°	KL-15X				0.8°	1.0°	1.1°	1.3°
KSL-15X				1.7°	2.8°	3.5°	5.3°	KSL-15X				1.0°	1.3°	1.4°	1.6°
KSL-20X				1.7°	2.9°	3.7°	5.6°	KSL-20X				1.0°	1.2°	1.4°	1.6°
LE-20X				1.5°	2.8°	3.6°	5.6°	LE-20X				1.0°	1.3°	1.4°	1.5°
LF-20X				2.2°	3.8°	4.9°	7.5°	LF-20X				1.2°	1.6°	1.7°	1.9°
LJ-20X				2.6°	4.3°	5.4°	8.3°	LJ-20X				1.6°	1.9°	2.1°	2.4°
LL-30X				3.2°	5.5°	7.0°	10.9°	LL-30X				1.9°	2.4°	2.6°	3.0°
LSG-40X				4.3°	7.2°	9.0°	13.7°	LSG-40X				2.3°	2.9°	3.2°	3.7°

Suction Gas Return 20°C / Subcooling 0K

* High Discharge Temp - Additional Cooling Required

For more details about other refrigerants please refer to select software.

Capacity Data

Condensing Temperature 40°C															
R407A	Cooling Capacity (kW)							R407A	Power Input (kW)						
	Evaporating Temperature (°C)								Evaporating Temperature (°C)						
Model	-30	-20	-10	-5	+5	+10	+15	Model	-30	-20	-10	-5	+5	+10	+15
KM-5X	0.5°	1.1°	1.8°	2.3°				KM-5X	0.5°	0.7°	0.8°	0.9°			
KM-7X		1.0°	1.7°	2.2°	3.5°	4.2°		KM-7X		0.7°	0.8°	0.9°	1.0°	1.0°	
KJ-7X	0.8°	1.5°	2.4°	3.0°				KJ-7X	0.7°	0.9°	1.1°	1.2°			
KJ-10X		1.5°	2.5°	3.2°	4.8°	5.8°		KJ-10X		0.9°	1.1°	1.2°	1.4°	1.4°	
KSJ-10X	1.1°	1.9°	3.1°	3.8°				KSJ-10X	0.9°	1.1°	1.4°	1.5°			
KSJ-15X		1.9°	3.2°	4.0°	6.0°	7.2°		KSJ-15X		1.2°	1.5°	1.6°	1.8°	1.8°	
KL-15X	1.2°	2.2°	3.6°	4.5°				KL-15X	0.9°	1.2°	1.6°	1.7°			
KL-20X		2.5°	3.9°	4.8°	7.0°	8.4°		KL-20X		1.3°	1.6°	1.7°	1.9°	2.0°	
KSL-20X		2.9°	4.5°	5.6°	8.3°	10.1°		KSL-20X		1.6°	1.9°	2.1°	2.4°	2.4°	
LE-20X	1.5°	2.8°	4.8°	6.0°	9.0°	10.9°		LE-20X	1.2°	1.6°	2.1°	2.3°	2.6°	2.7°	
LF-20X	2.1°	3.9°	6.4°	8.0°				LF-20X	1.6°	2.2°	2.7°	2.9°			
LF-30X		4.2°	6.7°	8.2°	12.2°	14.7°		LF-30X		2.3°	2.8°	3.0°	3.5°	3.6°	
LJ-20X	2.5°	4.7°	7.7°	9.6°				LJ-20X	1.9°	2.5°	3.1°	3.4°			
LJ-30X		5.0°	7.8°	9.5°	13.9°	16.6°		LJ-30X		2.6°	3.1°	3.4°	3.8°	4.0°	
LL-30X	2.9°	5.5°	9.1°	11.4°				LL-30X	2.1°	2.9°	3.6°	4.0°			
LL-40X		5.5°	9.1°	11.4°	16.9°	20.4°		LL-40X		2.8°	3.5°	3.8°	4.4°	4.6°	
LSG-40X	3.9°	7.0°	11.3°	14.0°				LSG-40X	2.7°	3.7°	4.7°	5.2°			

Conditions: Suction Gas Return 20°C / Subcooling 0K

Preliminary Data

° High Discharge Temp - Additional Cooling Required

Condensing Temperature 40°C															
R407F	Cooling Capacity (kW)							R407F	Power Input (kW)						
	Evaporating Temperature (°C)								Evaporating Temperature (°C)						
Model	-30	-20	-10	-5	+5	+10	+15	Model	-30	-20	-10	-5	+5	+10	+15
KM-5X	0.6°	1.1°	1.9°					KM-5X	0.5°	0.7°	0.9°				
KM-7X		1.1°	1.9°	2.4°	3.8°	4.6°		KM-7X		0.7°	0.9°	0.9°	1.1°	1.1°	
KJ-7X	0.9°	1.6°	2.6°	3.2°				KJ-7X	0.7°	0.9°	1.2°	1.3°			
KJ-10X		1.6°	2.7°	3.4°	5.1°	6.2°		KJ-10X		1.0°	1.2°	1.3°	1.5°	1.5°	
KSJ-10X	1.2°	2.1°	3.3°	4.1°				KSJ-10X	0.9°	1.2°	1.5°	1.6°			
KSJ-15X		2.0°	3.4°	4.2°	6.3°	7.5°		KSJ-15X		1.2°	1.5°	1.7°	1.9°	1.9°	
KL-15X	1.3°	2.4°	3.9°	4.9°				KL-15X	1.0°	1.3°	1.7°	1.8°			
KL-20X		2.6°	4.1°	5.1°	7.5°	8.9°		KL-20X		1.4°	1.7°	1.8°	2.0°	2.1°	
KSL-20X		3.1°	4.9°	6.0°	8.9°	10.7°		KSL-20X		1.7°	2.1°	2.2°	2.5°	2.6°	
LE-20X	1.6°	3.1°	5.2°	6.4°	9.6°	11.6°		LE-20X	1.3°	1.8°	2.2°	2.4°	2.7°	2.9°	
LF-20X	2.3°	4.2°	6.9°	8.6°				LF-20X	1.7°	2.3°	2.8°	3.1°			
LF-30X		4.6°	7.2°	8.9°	13.0°	15.6°		LF-30X		2.4°	2.9°	3.1°	3.5°	3.7°	
LJ-20X	2.7°	5.1°	8.3°	10.4°				LJ-20X	2.0°	2.7°	3.3°	3.6°			
LJ-30X		5.3°	8.3°	10.2°	14.8°	17.7°		LJ-30X		2.8°	3.4°	3.6°	4.1°	4.3°	
LL-30X	3.2°	5.8°	9.5°	11.9°				LL-30X	2.3°	3.1°	4.0°	4.4°			
LL-40X		5.9°	9.7°	12.1°	18.0°	21.7°		LL-40X		3.0°	3.7°	4.1°	4.7°	4.9°	
LSG-40X	4.3°	7.6°	12.2°					LSG-40X	2.9°	4.0°	5.0°				

Conditions: Suction Gas Return 20°C / Subcooling 0K

Preliminary Data

° High Discharge Temp - Additional Cooling Required

Capacity Data

Condensing Temperature 40°C															
R448A/ R449	Cooling Capacity (kW)							R448A/ R449	Power Input (kW)						
	Evaporating Temperature (°C)								Evaporating Temperature (°C)						
Model	-30	-20	-10	-5	+5	+10	+15	Model	-30	-20	-10	-5	+5	+10	+15
KM-5X	0.7°	1.2°						KM-5X	0.5°	0.6°					
KM-7X		1.2°	1.9°	2.4°	3.5°	4.3°		KM-7X		0.7°	0.8°	0.9°	1.0°	1.0°	
KJ-7X	0.9°	1.6°						KJ-7X	0.7°	0.9°					
KJ-10X		1.6°	2.6°	3.2°	4.8°	5.7°		KJ-10X		1.0°	1.1°	1.2°	1.3°	1.4°	
KSJ-10X	1.3°	2.1°						KSJ-10X	1.0°	1.2°					
KSJ-15X		2.1°	3.3°	4.1°	6.0°	7.1°		KSJ-15X		1.2°	1.5°	1.6°	1.7°	1.7°	
KL-15X	1.5°	2.4°						KL-15X	1.0°	1.3°					
LE-20X		3.0°	5.0°	6.2°	5.3°	11.3°		LE-20X		1.5°	1.9°	2.0°	2.3°	2.4°	
LF-30X		4.4°	6.9°	8.4°	12.4°	14.8°		LF-30X		2.4°	2.9°	3.1°	3.5°	3.6°	
LF-20X	2.1°	3.8°						LF-20X	1.5°	2.0°					
LJ-20X	2.6°	4.7°						LJ-20X	1.7°	2.3°					
LJ-30X		4.7°	7.6°	9.4°	13.9°	16.6°		LJ-30X		2.5°	3.1°	3.3°	3.6°	3.7°	
LL-30X		6.1°						LL-30X	2.1°	3.0°					
LL-40X		5.9°	9.7°	12.0°	18.0°	21.7°		LL-40X		3.0°	3.6°	4.0°	4.5°	4.8°	
LSG-40X	4.4°	7.6°						LSG-40X	2.7°	3.7°					

Conditions: Suction Gas Return 20°C / Subcooling 0K

Preliminary Data

° High Discharge Temp - Additional Cooling Required



Discus™ Reciprocating Compressor Range

From 2, 3 and 8 cylinder semi-hermetic reciprocating compressors for medium/low temperature refrigeration and high temperature applications like process cooling or air-conditioning.

The key difference between Discus and traditional reciprocating technologies lies in the valve plate design. The Discus valve plate allows gas to flow into the cylinders with a minimum heat gain, while suction cavities are designed to smoothly route the gas to minimize losses. These effects lead to:

- Superior cooling capacity due to no re-expansion volume
- Up to 10% higher efficiency compared to conventional “cost-effective” reed type compressors
- Lower operating costs for the end-user

The Discus ranges from 5 to 60 hp with a displacement of 16.8 to 181. These compressors are qualified for R407A/F/C, R448A/R449A, R404A, R134a, R450A and R513A. All Discus compressors are designed to deliver maximum performance and reliability:

- Discus “puck” valve integrated into the valve plate for highest performance whatever the operating condition
- Positive displacement high flow oil pump guarantees high oil feeding pressure for good lubrication and bearings’ cooling



Discus Compressor

- PTFE-coated bearings for especially low friction and good protection at start-up
- Electronic motor protection module
- Availability of two motor sizes per displacement. The small motor covers all refrigeration applications while the large motor can be used in comfort, process cooling or inverter applications

Discus Compressor Line-Up

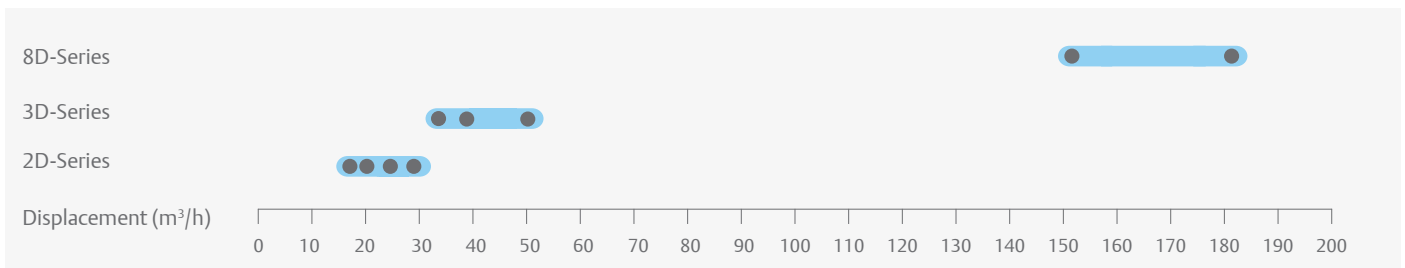

Features and Benefits

- Highest level of efficiency available on the market, whatever the refrigerant and operating condition
- Integrated oil pump and Electronic Oil Pressure Switch OPS2 for maximum reliability
- Two motor sizes per displacement, optimized for different applications
- Large operating envelope that allows medium and low temperature applications to be covered by one single model with condensing limit as low as 5°C
- Provide cooling capacity modulation either by cylinder head blocked suction or with use of frequency inverters from 25 to 60Hz
- Multi-refrigerant compressor range – one model to cover all standard refrigerants
- Option to use 2 and 3 cylinder models with additional Demand Cooling function in order to achieve extended low temperature operating envelope without any superheat restriction for new refrigerants R407A/F, R448A and R449A

Operating Envelope R404A

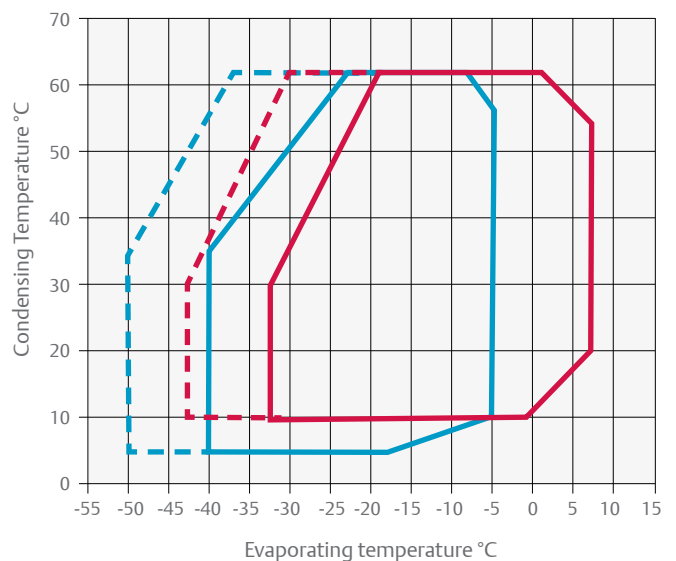

- Large Motor 20°C SGRT
- - - Large Motor 20°C SGRT + Fan
- Small Motor 20°C SGRT
- - - Small Motor 0°C SGRT + Fan

For individual model details please refer to select software.

Maximum Allowable Pressure (PS)

- Low Side PS 22.5 bar (g)/ High Side PS 28 bar (g)

Operating Envelope R407A

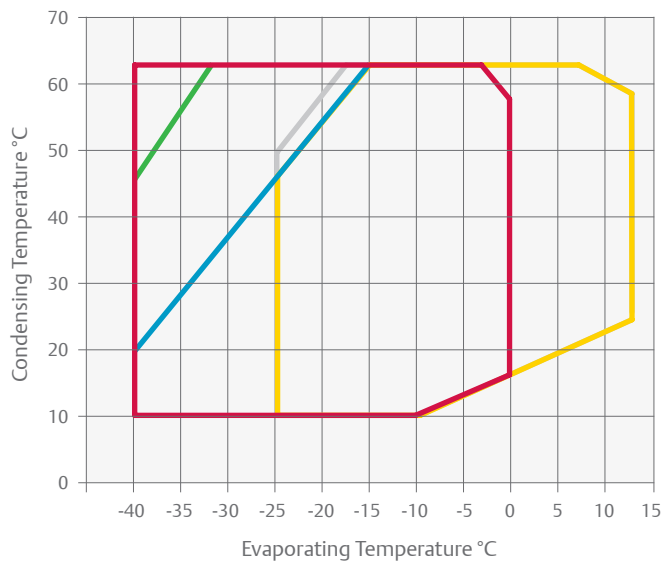

- Large Motor 0°C SGRT
- Large Motor 20°C SGRT
- Small Motor 20K Suction Superheat
- Small Motor 20°C SGRT
- Small Motor 20°C SGRT Demand cooling

Operating Envelope R407F

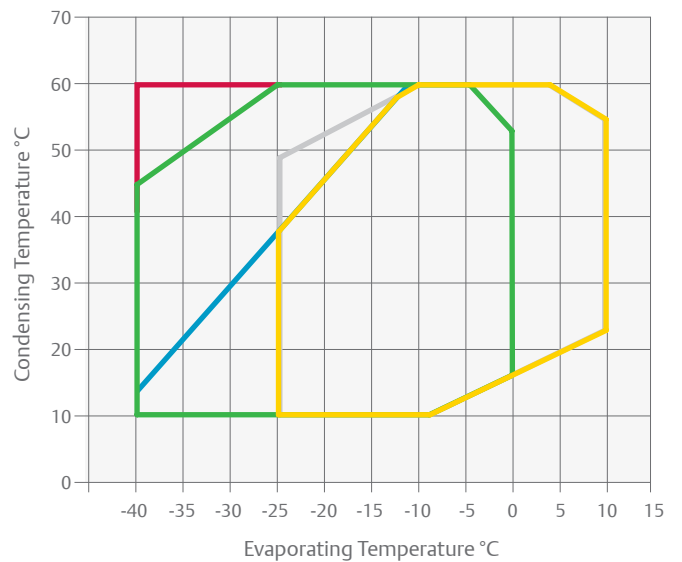

- Large Motor 0°C SGRT
- Large Motor 20°C SGRT
- Small Motor 20K Suction Superheat
- Small Motor 20°C SGRT
- Small Motor 20°C SGRT Demand cooling

Operating Envelope R448A/R449A

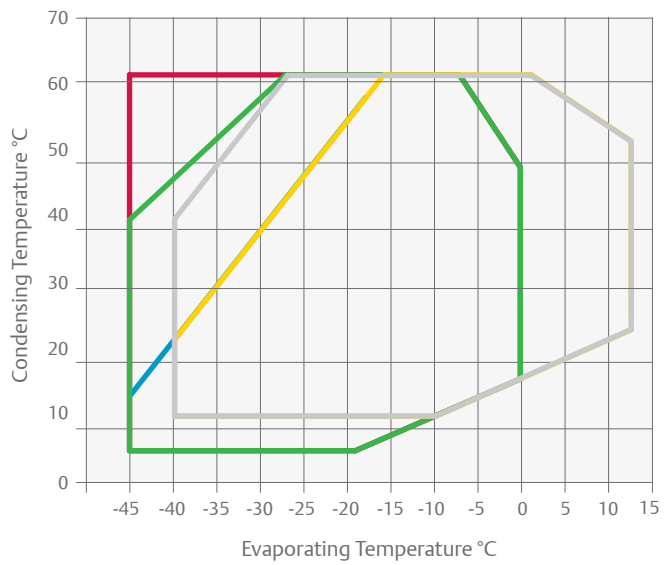

- Large Motor 20K Superheat
- Large Motor 20°C SGRT
- Small Motor 20K Suction Superheat
- Small Motor 20°C SGRT
- Small Motor 20°C SGRT Demand cooling

Operating Envelope R134a

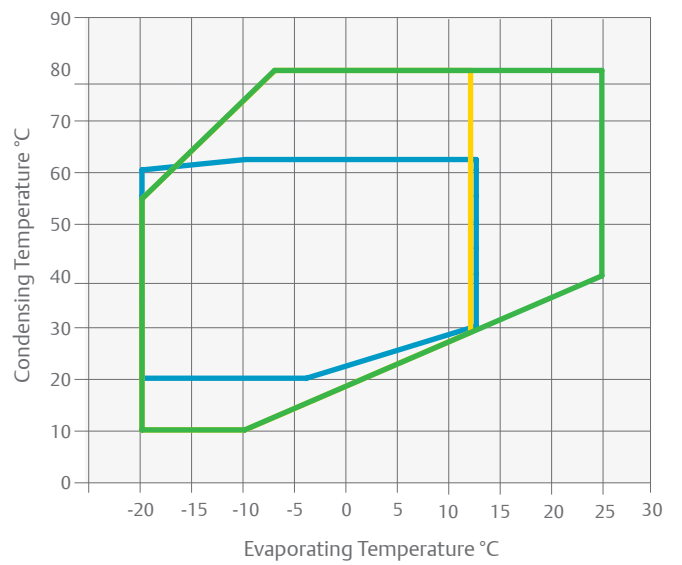

- Large Motor 20°C SGRT
- Small Motor 25°C SGRT
- Large Motor 20K Superheat

Technical Overview

Models	Nominal hp	Displacement (m ³ /h)	Oil Quantity (l)	Length/Width/Height (mm)	Net Weight (kg)	Motor Version/Code	Maximum Operating Current (A)	Locked Rotor Current (A)	Sound Pressure @1 m - dB(A)***
						3 Ph**	3 Ph**	3 Ph**	
2DC-50X	5	16.8	2.3	590/330/470	132	AWM	9	55	65
2DD-50X	5	19.3	2.3	590/330/470	132	AWM	10.3	55	65
2DL-40X	4	23.7	2.3	590/330/470	131	AWM	11.1	55	64
2DL-75X	7.5	23.7	2.3	590/330/470	136	AWM	13.8	70	66
2DB-50X	5	28	2.3	590/330/470	131	AWM	13.4	55	64
2DB-75X	7.5	28	2.3	590/330/470	136	AWM	16.1	70	66
3DA-50X	5	32.2	3.7	655/370/480	146	AWM	15.9	55	69
3DA-75X	7.5	32.2	3.7	680/370/480	152	AWM	17.5	106	69
3DC-75X	7.5	38	3.7	655/370/480	150	AWM	18.3	70	71
3DC-100X	10	38	3.7	680/370/480	164	AWM	20.5	121	70
3DS-100X	10	49.9	3.7	680/370/480	162	AWM	24.4	121	70
3DS-150X	15	49.9	3.7	710/370/490	166	AWM	29	125.7	70
8DH-500X	50	151	7.6	835/475/610	330	AWM	88.2	458	79
8DL-370X	37	151	7.6	835/475/610	323	AWM	74.3	349	76
8DJ-600X	60	181	7.6	835/475/610	331	AWM	108	476	79
8DT-450X	45	181	7.6	835/475/610	335	AWM	90.7	441	78

** 3 Ph: 380-420V/ 50Hz

*** @ 1m: sound pressure level at 1m distance from the compressor, free field condition

Capacity Data

Condensing Temperature: 40°C															
R407A	Cooling Capacity (kW)							R407A	Power Input (kW)						
	Evaporating Temperature (°C)								Evaporating Temperature (°C)						
Model	-45	-35	-30	-20	-10	-5	+5	Model	-45	-35	-30	-20	-10	-5	+5
2DC-50X		1.7	2.4	4.5	7.8	10.0	15.5	2DC-50X		1.4	1.7	2.3	2.9	3.2	3.6
2DD-50X		2.1	3.1	5.8	9.5	12.0	18.1	2DD-50X		1.7	2.1	2.7	3.4	3.7	4.1
2DL-40X		2.5*	3.7*	7.4	11.9	14.8		2DL-40X		2.3*	2.7*	3.5	4.3	4.6	
2DL-75X				7.2	11.9	14.8	22.1	2DL-75X				3.5	4.2	4.5	4.8
2DB-50X		3.3*	4.6*	9.0	14.4	17.8		2DB-50X		2.8*	3.3*	4.3	5.2	5.6	
2DB-75X				9.0	14.3	17.7	26.1	2DB-75X				4.4	5.3	5.7	6.1
3DA-50X		3.8*	5.4*	10.4	16.4	20.2		3DA-50X		3.2*	3.8*	5.0	6.1	6.5	
3DA-75X				10.3	16.7	20.7	30.8	3DA-75X				5.0	6.0	6.4	6.9
3DC-75X		4.7*	6.5*	12.4	19.6	24.2		3DC-75X		3.9*	4.6*	6.0	7.2	7.8	
3DC-100X				12.6	20.3	25.1	37.0	3DC-100X				5.8	7.1	7.6	8.1
3DS-100X		6.4*	9.1*	16.9	26.3	32.1		3DS-100X		5.2*	6.1*	7.9	9.6	10.3	
3DS-150X				16.8	26.6	32.7	48.0	3DS-150X				7.9	9.6	10.2	11.1
8DH-500X				49.1	78.8	97.7	146.0	8DH-500X				24.1	28.8	31.0	33.9
8DL-370X		20.7*	28.8*	53.6	85.3	105.5		8DL-370X		17.4*	19.8*	25.2	30.5	33.0	
8DJ-600X				60.3	95.5	118.0	174.5	8DJ-600X				28.9	35.1	37.9	42.2
8DT-450X		24.0*	32.6*	59.6	93.3	114.5		8DT-450X		20.1*	23.2*	29.5	35.8	38.6	

Suction Gas Return 20°C / Subcooling 0K

* 10K Border

Capacity Data

R407F	Cooling Capacity (kW)							R407F	Power Input (kW)						
	Evaporating Temperature (°C)								Evaporating Temperature (°C)						
Model	-45	-35	-30	-20	-10	-5	+5	Model	-45	-35	-30	-20	-10	-5	+5
2DC-50X		1.1*	1.9*	4.7	8.0	10.1	15.4	2DC-50X		1.4*	1.7*	2.4	3.1	3.3	3.6
2DD-50X		1.6*	2.6*	5.9	9.7	12.1	18.1	2DD-50X		1.7*	2.1*	2.9	3.6	3.8	4.1
2DL-40X		2.6*	3.9*	7.7	12.4	15.3		2DL-40X		2.4*	2.8*	3.7	4.5	4.9	
2DL-75X				7.6	12.5	15.6	23.4	2DL-75X				3.7	4.4	4.6	5.0
2DB-50X		3.9*	5.4*	9.8	15.3	18.8		2DB-50X		2.9*	3.4*	4.5	5.4	5.8	
2DB-75X				9.6	15.3	18.9	27.9	2DB-75X				4.6	5.6	6.0	6.3
3DA-50X		4.3*	6.1*	11.3	17.9	22.1		3DA-50X		3.4*	4.0*	5.2	6.4	6.8	
3DA-75X				11.4	18.4	22.8	33.8	3DA-75X				5.2	6.3	6.8	7.2
3DC-75X		5.4*	7.5*	13.8	21.6	26.6		3DC-75X		4.2*	4.8*	6.2	7.5	8.1	
3DC-100X				14.0	22.1	27.3	40.2	3DC-100X				6.1	7.4	7.9	8.5
3DS-100X		7.3*	10.2*	18.4	28.8	35.3		3DS-100X		5.5*	6.4*	8.3	10.0	10.8	
3DS-150X				18.8	29.7	36.4	53.2	3DS-150X				8.2	10.1	10.8	11.8
8DL-370X		20.8*	28.9*	53.6	85.3	105.5		8DL-370X		17.4*	19.8*	25.2	30.5	33.0	
8DH-500X				53.0	84.6	105.0	156.5	8DH-500X				25.8	30.5	32.2	34.9
8DJ-600X				63.7	101.0	125.0	187.5	8DJ-600X				30.6	36.9	39.8	43.9
8DT-450X		26.8*	35.9*	64.1	100.5	123.5		8DT-450X		21.8*	24.7*	31.2	37.7	40.7	

Suction Gas Return 20°C / Subcooling 0K

* 10K Border

Condensing Temperature 40°C															
R448A/ R449	Cooling Capacity (kW)							R448A/ R449	Power Input (kW)						
	Evaporating Temperature (°C)								Evaporating Temperature (°C)						
Model	-45	-35	-30	-20	-10	-5	+5	Model	-45	-35	-30	-20	-10	-5	+5
2DC-50X		1.4*	2.4*	5.1	8.4	10.6	15.9	2DC-50X		1.4*	1.7*	2.4	3.0	3.3	3.5
2DD-50X		1.7*	2.7*	5.8	9.7	12.1	18.2	2DD-50X		1.6*	2.0*	2.8	3.5	3.8	4.1
2DL-40X	1.0*	2.7*	3.9*	7.5	12.2	15.2		2DL-40X	1.5*	2.3*	2.7*	3.5	4.4	4.9	
2DL-75X		2.5*	3.7*	7.3	12.1	15.2	23.2	2DL-75X		2.3*	2.7*	3.5	4.3	4.6	5.1
2DB-50X	1.4*	3.6*	5.0*	9.2	14.7	18.2		2DB-50X	2.0*	2.8*	3.3*	4.4	5.4	5.8	
2DB-75X		3.8*	5.2*	9.4	15.0	18.6	27.6	2DB-75X		3.0*	3.5*	4.4	5.3	5.7	6.2
3DA-50X	1.9*	4.1*	5.6*	10.2	16.1	19.8		3DA-50X	2.3*	3.3*	3.9*	5.0	6.2	6.6	
3DA-75X		3.9*	5.8*	11.0	17.6	21.8	32.3	3DA-75X		3.3*	4.0*	5.2	6.1	6.5	6.8
3DC-75X	2.7*	5.1*	6.9*	12.4	19.4	23.8		3DC-75X	2.9*	4.0*	4.6*	6.0	7.3	7.8	
3DC-100X		4.4*	6.9*	13.3	21.1	25.9	37.7	3DC-100X		3.6*	4.4*	6.0	7.2	7.6	8.1
3DC-75X DC	2.6	5.4	7.3	12.4	19.5	23.9		3DC-75X DC	2.9	4.0	4.6	6.0	7.3	7.8	
3DS-100X	3.8*	7.1*	9.5*	16.9	26.5	32.5		3DS-100X	4.0*	5.4*	6.2*	8.1	9.8	10.6	
3DS-150X		7.5*	10.2*	17.8	27.6	33.7	49.1	3DS-150X		5.6*	6.4*	8.2	9.8	10.5	11.5
8DH-500X		18.7*	27.4*	51.0	80.6	99.2	145.0	8DH-500X		15.9*	18.8*	24.4	29.3	31.3	34.0
8DL-370X	7.4*	18.4*	26.2*	49.3	79.0	97.6		8DL-370X	11.5*	16.6*	19.3*	24.6	29.3	31.4	
8DJ-600X		24.2*	34.0*	61.7	96.9	119.0	174.5	8DJ-600X		19.3*	22.5*	29.2	35.6	38.4	42.9
8DT-450X	12.2*	25.4*	34.7*	62.0	97.7	120.0		8DT-450X	14.9*	20.1*	23.2*	29.6	36.0	38.8	

Conditions: Suction Gas Return 20°C / Subcooling 0K

*Conditions: Suction Superheat 10K, Subcooling 0K

Preliminary Data

Capacity Data

Condensing Temperature: 40°C															
R404A	Cooling Capacity (kW)							R404A	Power Input (kW)						
	Evaporating Temperature (°C)								Evaporating Temperature (°C)						
Model	-45	-35	-30	-20	-10	-5	+5	Model	-45	-35	-30	-20	-10	-5	+5
2DC-50X		2.1°	3.0°	5.4	8.8	11.0	16.5	2DC-50X		1.7°	2.1°	2.7	3.3	3.6	3.8
2DD-50X		2.8°	3.9°	6.8	10.8	13.2	19.3	2DD-50X		2.2°	2.5°	3.3	3.9	4.1	4.3
2DL-40X	1.2*	3.8	5.1	8.5	13.2	16.2		2DL-40X	1.8*	2.7	3.2	4.1	4.9	5.3	
2DL-75X		3.6°	4.9°	8.4	13.4	16.5	24.1	2DL-75X		2.7°	3.1°	4.0	4.8	5.1	5.5
2DB-50X	1.7*	4.6	6.2	10.4	16.0	19.4		2DB-50X	2.2*	3.2	3.8	4.9	5.9	6.3	
2DB-75X		4.9°	6.4°	10.5	16.2	19.8	28.6	2DB-75X		3.5°	4.0°	5.1	6.1	6.5	7.0
3DA-50X	2.0*	5.7	7.4	11.9	17.9	21.7		3DA-50X	2.7*	4.0	4.7	5.9	6.9	7.3	
3DA-75X		5.2°	7.2°	12.2	18.9	23.1	33.4	3DA-75X		3.9°	4.6°	5.9	6.9	7.3	7.6
3DC-75X	2.8*	7.0	9.1	14.4	21.6	26.1		3DC-75X	3.4*	4.9	5.6	7.0	8.2	8.7	
3DC-100X		6.6°	8.9°	14.9	22.7	27.5	39.3	3DC-100X		4.6°	5.4°	6.9	8.1	8.5	8.9
3DS-100X	4.0*	9.6	12.5	19.8	29.5	35.5		3DS-100X	4.7*	6.5	7.5	9.4	11.1	11.7	
3DS-150X		9.1°	12.2°	19.9	30.2	36.5	51.9	3DS-150X		6.3°	7.4°	9.4	11.1	11.6	12.0
8DH-500X		26.3°	35.7°	58.8	89.3	108.0	153.5	8DH-500X		19.1°	22.1°	27.9	32.8	34.7	37.3
8DL-370X	10.8*	28.0	36.9	59.3	88.8	106.5		8DL-370X	13.2*	19.5	22.4	27.9	32.7	34.7	
8DJ-600X		32.7°	44.0°	71.3	107.0	128.5	181.0	8DJ-600X		23.0°	26.8°	33.7	39.5	41.9	45.5
8DT-450X	14.2*	34.7	44.9	70.6	105.0	125.5		8DT-450X	16.9*	23.7	27.2	34.0	40.2	42.8	

Suction Gas Return 20°C / Subcooling 0K

° High Discharge Temp - Additional Cooling Required

* 10K Border

Condensing Temperature: 40°C															
R134a	Cooling Capacity (kW)							R134a	Power Input (kW)						
	Evaporating Temperature (°C)								Evaporating Temperature (°C)						
Model	-45	-35	-30	-20	-10	-5	+5	Model	-45	-35	-30	-20	-10	-5	+5
2DC-50X				2.4*	4.7*	6.3*	10.3	2DC-50X				1.5*	2.0*	2.1*	2.3
2DD-50X				3.1*	5.8*	7.6*	12.2	2DD-50X				1.9*	2.3*	2.5*	2.7
2DL-40X				4.0	7.2	9.2	14.4	2DL-40X				2.3	2.8	3.1	3.4
2DL-75X				3.6*	6.8*	8.9*	14.3	2DL-75X				2.1*	2.7*	3.0*	3.3
2DB-50X				5.2	9.1	11.6	17.9	2DB-50X				2.6	3.3	3.6	4.0
2DB-75X				4.5*	8.2*	10.6*	17.0	2DB-75X				2.6*	3.3*	3.5*	3.9
3DA-50X				6.0	10.2	12.9	19.8	3DA-50X				3.0	3.7	4.0	4.4
3DA-75X				5.1*	9.6*	12.5*	20.1	3DA-75X				3.1*	3.8*	4.1*	4.5
3DC-75X				7.4	12.5	15.7	23.9	3DC-75X				3.6	4.5	4.8	5.3
3DC-100X				6.8*	12.0*	15.3*	24.2	3DC-100X				3.7*	4.5*	4.8*	5.2
3DS-100X				9.7	16.2	20.4	31.0	3DS-100X				4.7	5.9	6.4	7.2
3DS-150X				9.7*	16.3*	20.6*	31.7	3DS-150X				5.0	6.2*	6.6*	7.3
8DH-500X				28.6*	47.9*	60.9*	95.6	8DH-500X				15.5*	18.8*	20.2*	22.2
8DJ-600X				34.4*	57.5*	72.9*	114.0	8DJ-600X				18.1*	22.2*	24.0*	26.8
8DL-370X				31.4	51.6	64.5	97.3	8DL-370X				15.1	18.5	19.9	22.2
8DT-450X				38.7	62.1	77.1	115.0	8DT-450X				18.4	22.5	24.4	27.5

Suction Gas Return 20°C / Subcooling 0K

* 10K Border

Discus™ Digital (3Cylinder) Reciprocating Compressor With Continuous Capacity Modulation

Discus Digital series with 3 cylinder compressors provide an alternative means of continuous modulation to inverter. Digital modulation is the most simple and precise method of capacity control and helps to contain applied costs associated with modulation.

Digital technology is based on controlling a high-cycle solenoid valve fitted on one of the cylinder heads based on cycle time. The valve actuates a piston that controls the flow of gas into the suction area of the Discus valve plate.

The compressor always runs at constant speed which resolves the challenges related to oil return, mechanical and electrical stress on the system.



Discus Digital 3 Cylinder Compressor

Discus Digital Compressor Line-up

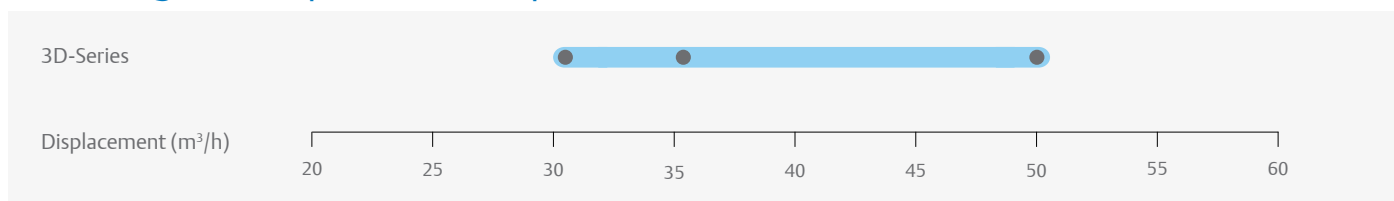

Features and Benefits

- Range of 6 models from 32 to 50 m³/h
- Compatible with R407A/F/C, R448A/ R449A, R404A, R134a, R450A and R513A.
- Continuous modulation from 10–100% ensuring a perfect match of capacity and power to refrigeration load
- Economical and reliable alternative to frequency inverters
- Precise suction pressure control with associated energy savings and stable evaporating temperatures
- Quick and easy integration into refrigeration equipment, similar to any other standard compressor
- Possibility to easily retrofit existing installations with digital cylinder head kit
- No vibrations or mechanical stress on system piping and compressor parts
- Reduced compressor cycling for longer contactor and compressor life

Operating Envelope R404A

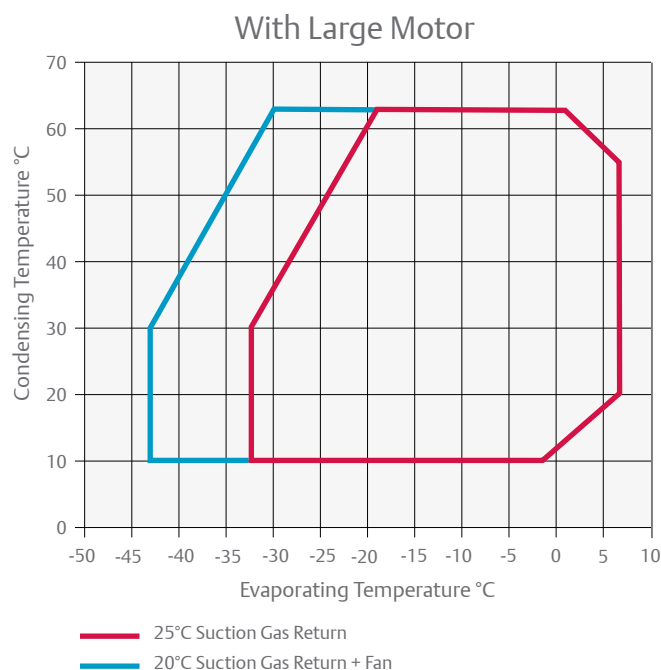
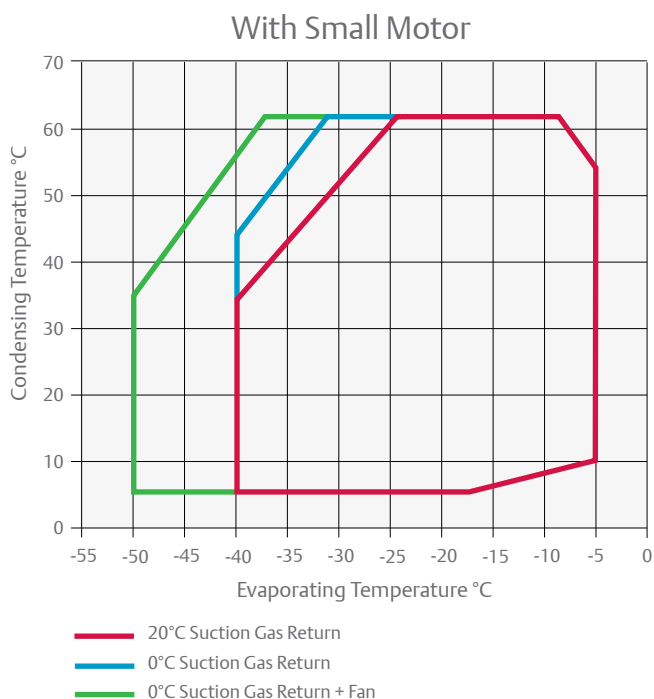

Operating Envelope R407A

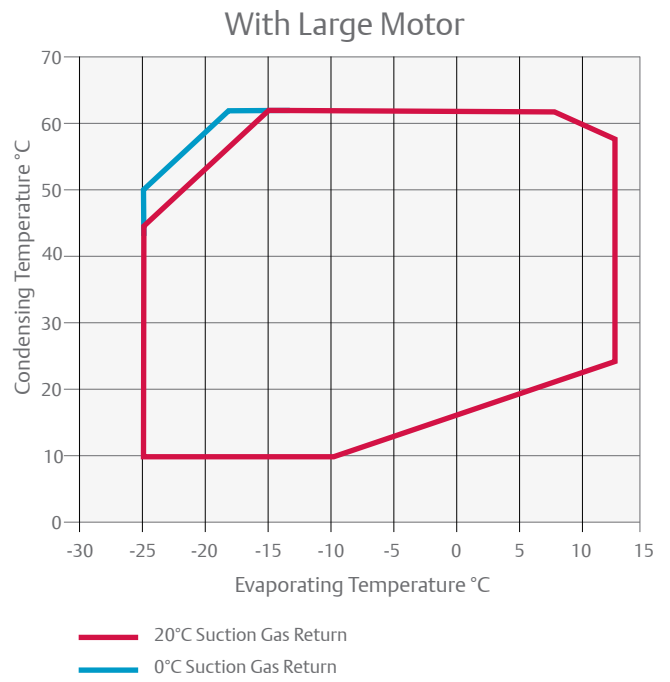
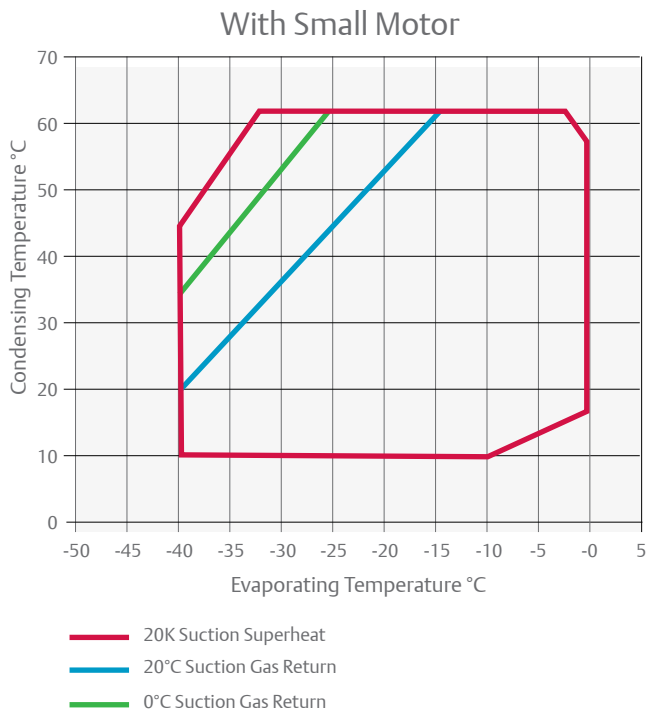

Operating Envelope R407F

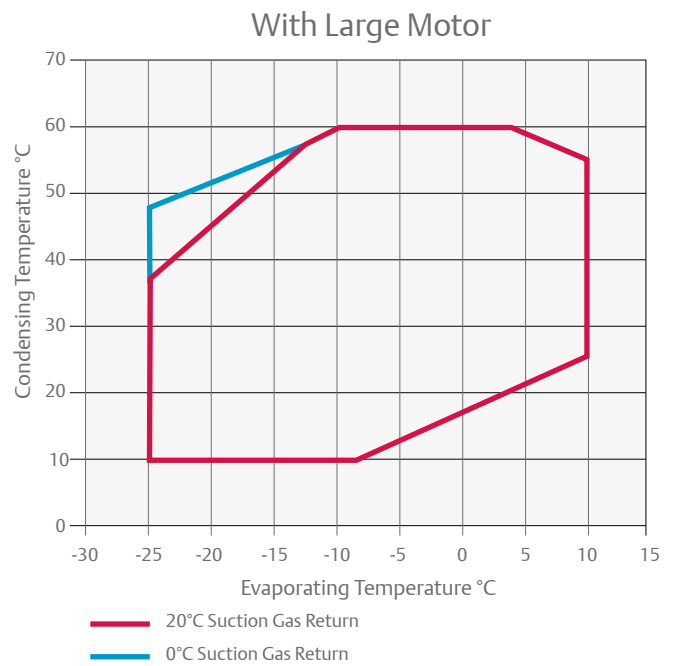
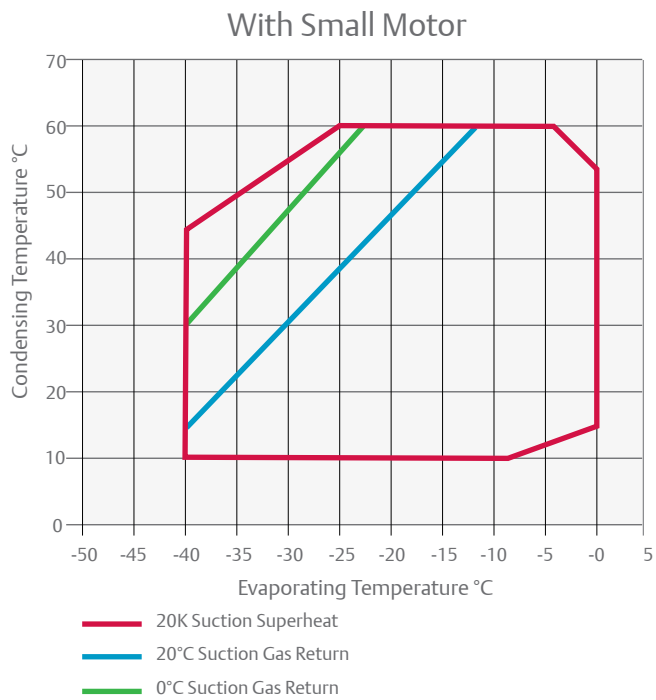

Operating Envelope R448A/R449A

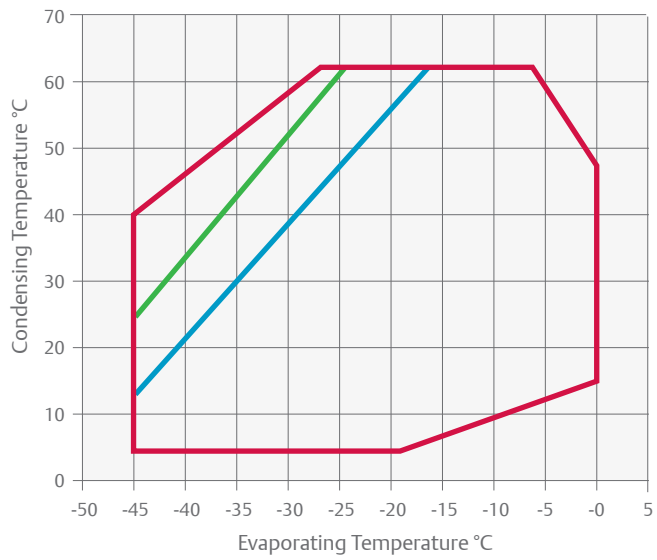

- 20K Suction Superheat
- 20°C Suction Gas Return
- 0°C Suction Gas Return

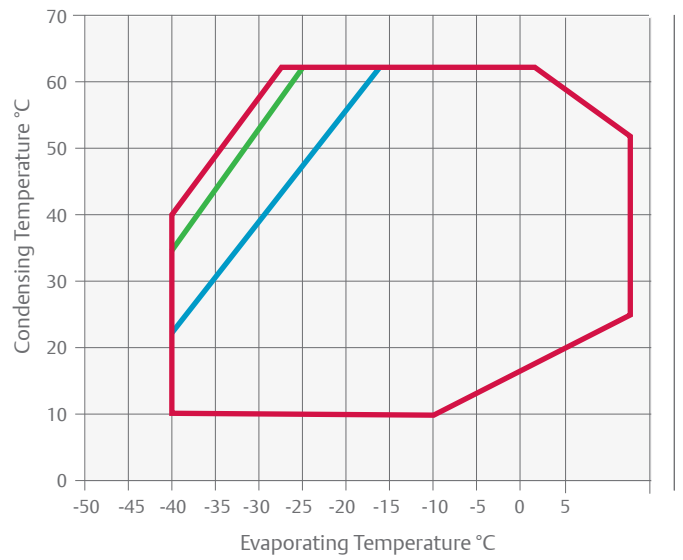

- 20K Suction Superheat
- 20°C Suction Gas Return
- 0°C Suction Gas Return

Technical Overview

Models	Nominal hp	Displacement (m ³ /h)	Oil Quantity (l)	Length/Width/Height (mm)	Net Weight (kg)	Motor Version/Code	Maximum Operating Current (A)	Locked Rotor Current (A)	Sound Pressure @ 1 m - dB(A)***
						3 Ph**	3 Ph**	3 Ph**	
3DAD-50X	5.0	32.2	3.7	655/370/480	146.0	AWM	15.7	55.0	65.0
3DAD-75X	7.5	32.2	3.7	680/370/480	152.0	AWM	18.6	106.0	67.0
3DCD-75X	7.5	38.0	3.7	655/370/480	150.0	AWM	18.5	70.0	67.0
3DCD-100X	10.0	38.0	3.7	680/370/480	164.0	AWM	21.6	121.0	68.0
3DSD-100X	10.0	49.9	3.7	680/370/480	162.0	AWM	24.4	121.0	69.0
3DSD-150X	15.0	49.9	3.7	710/370/490	166.0	AWM	29.7	129.0	69.0

** 3 Ph: 380-420V/ 50Hz

*** @ 1m: sound pressure level at 1m distance from the compressor, free field condition

Capacity Data

R407A	Cooling Capacity (kW)							R407A	Power Input (kW)						
	Condensing Temperature 40°C								Condensing Temperature 40°C						
	Evaporating Temperature (°C)								Evaporating Temperature (°C)						
Model	-30	-20	-10	-5	5	10	15	Model	-30	-20	-10	-5	5	10	15
3DAD-50X	5.3*	10.3	16.2	19.9				3DAD-50X	3.8*	5.0	6.1	6.5			
3DAD-75X		10.2	16.4	20.4	30.4	36.5		3DAD-75X		5.0	6.0	6.4	6.9	6.9	
3DCD-100X		12.4	20.0	24.7	36.6	43.9		3DCD-100X		5.8	7.1	7.6	8.3	8.3	
3DCD-75X	6.4*	12.3	19.4	23.8				3DCD-75X	4.6*	6.0	7.2	7.8			
3DSD-100X	8.9*	16.7	25.9	31.6				3DSD-100X	6.1*	7.9	9.6	10.3			
3DSD-150X		16.5	26.2	32.2	47.6	57.0		3DSD-150X		7.8	9.6	10.3	11.2	11.3	

Suction Gas Return 20°C / Subcooling 0K, 100% Loaded

*Suction Superheat 10K, Subcooling 0K

R407F	Cooling Capacity (kW)							R407F	Power Input (kW)						
	Condensing Temperature 40°C								Condensing Temperature 40°C						
	Evaporating Temperature (°C)								Evaporating Temperature (°C)						
Model	-30	-20	-10	-5	5	10	15	Model	-30	-20	-10	-5	5	10	15
3DAD-50X	6.0*	11.2	17.8	21.9				3DAD-50X	4.0*	5.2	6.4	6.8			
3DAD-75X		11.3	18.2	22.6	33.6	40.4		3DAD-75X		5.2	6.3	6.8	7.2	7.2	
3DCD-75X	7.4*	13.7	21.5	26.4				3DCD-75X	4.8*	6.2	7.5	8.1			
3DCD-100X		13.9	21.9	27.0	39.8	47.8		3DCD-100X		6.0	7.3	7.9	8.6	8.6	
3DSD-100X	10.0*	18.2	28.5	35.0				3DSD-100X	6.3*	8.3	10.1	10.8			
3DSD-150X		18.4	29.2	36.0	53.0	63.4		3DSD-150X		8.2	10.1	10.9	11.9	12.0	

Suction Gas Return 20°C / Subcooling 0K, 100% Loaded

*Suction Superheat 10K, Subcooling 0K

Capacity Data

R448A/ R449A	Cooling Capacity (kW)							R448A/ R449A	Power Input (kW)						
	Condensing Temperature 40°C								Condensing Temperature 40°C						
	Evaporating Temperature (°C)								Evaporating Temperature (°C)						
Model	-30	-20	-10	-5	5	10	15	Model	-30	-20	-10	-5	5	10	15
3DAD-50X	5.6*	10.2	16.1	19.8				3DAD-50X	3.9*	5.0	6.2	6.6			
3DAD-75X	6.7*	11.9	18.3	22.2	31.8	37.6		3DAD-75X	4.4*	5.7	6.8	7.2	7.5	7.4	
3DCD-75X	6.9*	12.4	19.4	23.8				3DCD-75X	4.6*	6.0	7.3	7.8			
3DCD-100X	7.3*	13.4	21.1	26.0	38.0	45.4		3DCD-100X	4.7*	6.1	7.2	7.6	8.0	7.9	
3DSD-150X	10.2*	17.8	27.6	33.7	49.1	58.4		3DSD-150X	6.4*	8.2	9.8	10.5	11.5	11.8	
3DSD-100X	9.5*	16.9	26.5	32.5				3DSD-100X	6.2*	8.1	9.8	10.6			

Suction Gas Return 20°C / Subcooling 0K, 100% Loaded

*Suction Superheat 10K, Subcooling 0K

Preliminary Data

R404A	Cooling Capacity (kW)							R404A	Power Input (kW)						
	Condensing Temperature 40°C								Condensing Temperature 40°C						
	Evaporating Temperature (°C)								Evaporating Temperature (°C)						
Model	-30	-20	-10	-5	5	10	15	Model	-30	-20	-10	-5	5	10	15
3DAD-75X	7.1	11.9	18.3	22.2	31.8			3DAD-75X	4.4	5.7	6.8	7.2	7.5		
3DAD-50X	7.3	11.8	17.8	21.5				3DAD-50X	4.6	5.9	6.9	7.3			
3DCD-75X	8.8	14.1	21.2	25.6				3DCD-75X	5.5	7.0	8.2	8.6			
3DCD-100X	8.6	14.3	21.8	26.5	37.9			3DCD-100X	5.3	6.8	8.0	8.4	8.9		
3DSD-150X	12.1	19.1	28.6	34.6	49.3			3DSD-150X	7.3	9.2	11.0	11.6	12.3		
3DSD-100X	11.9	18.9	28.3	34.1				3DSD-100X	7.4	9.3	10.9	11.6			

Suction Gas Return 20°C / Subcooling 0K, 100% Loaded

High Discharge Temp - Additional Cooling Required

R134a	Cooling Capacity (kW)							R134a	Power Input (kW)						
	Condensing Temperature 40°C								Condensing Temperature 40°C						
	Evaporating Temperature (°C)								Evaporating Temperature (°C)						
Model	-30	-20	-10	-5	5	10	15	Model	-30	-20	-10	-5	5	10	15
3DAD-50X		6.3	10.4	13.0	19.8	24.1		3DAD-50X		3.0	3.8	4.1	4.5	4.6	
3DAD-75X		5.5*	9.8*	12.6*	20.0	24.5	29.6	3DAD-75X		3.1*	3.8*	4.1*	4.5	4.5	4.5
3DCD-75X		7.5	12.4	15.6	23.5	28.5		3DCD-75X		3.6	4.5	4.9	5.4	5.5	
3DCD-100X		6.8*	11.9*	15.2*	23.8	29.0	34.9	3DCD-100X		3.7*	4.5*	4.8*	5.2	5.3	5.3
3DSD-100X		10.2	16.6	20.6	31.0	37.5		3DSD-100X		4.8	6.0	6.4	7.1	7.3	
3DSD-150X		9.1*	15.7*	19.9*	31.0	37.5	44.9	3DSD-150X		4.8*	6.0*	6.6*	7.3	7.4	7.3

Suction Gas Return 20°C / Subcooling 0K, 100% Loaded

*Suction Superheat 10K, Subcooling 0K



Copeland™ Stream With CoreSense™ Diagnostics, Semi-Hermetic Reciprocating Compressors for HFC / HFO Blends

Stream series 4 and 6 cylinder compressors provide best-in-class performance, thereby significantly reducing cost of operation and environmental impact compared to competing products. With advanced protection and diagnostics features for system reliability, reduced service costs and increased equipment uptime, Stream series is built to last in today's modern changing world.



Copeland Stream Compressor
Designed to Deliver Best-in-Class Performance

Stream Compressor Line-Up

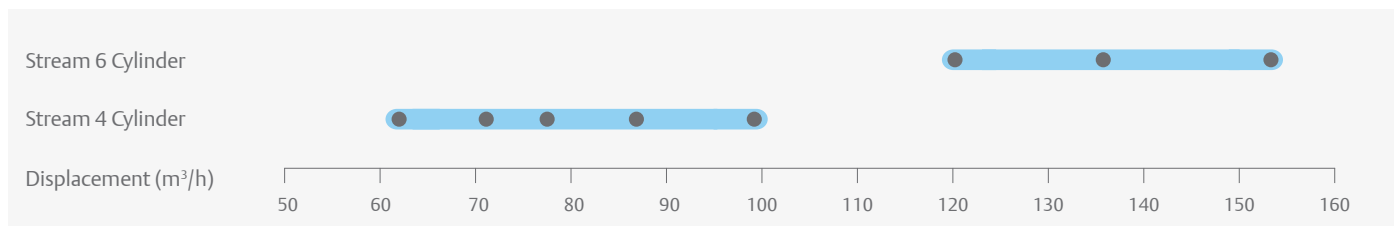

Features and Benefits

- Range of 16 models from 62 to 153m³/h
- Best-in-class seasonal efficiencies, up to 15% higher than market standard
- Multi-refrigerant compressor as it is compatible with R407A/ F/C, R448A/ R449A, R404A, R134a, R450A and R513A
- Stepless capacity modulation by means of inverter or Digital modulation
- Wide operating envelope covering low- and medium-temperature refrigeration without cooling fan
- Reduced sound level, dimensions and weight by up to 45 kg
- CoreSense protection available as option
- Option to use compressors with additional Demand Cooling function in order to achieve extended low temperature operating envelope without any superheat restriction for new refrigerants R407A/F, R448A and R449A

CoreSense Diagnostics Features

- Motor and oil protection
- Storage of compressor asset and advanced runtime information
- Runtime/alarm signalling using multi-colour LED flash-codes
- Communication to system controller via Modbus®
- Individual compressor power monitoring

Operating Envelope R404A

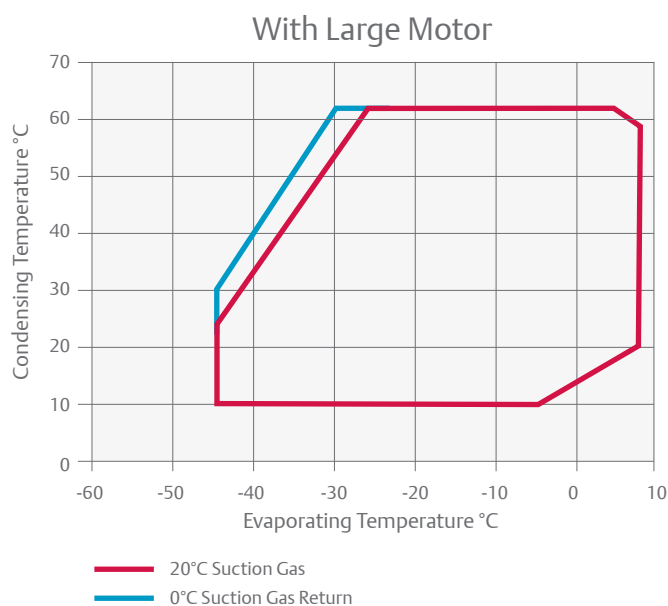
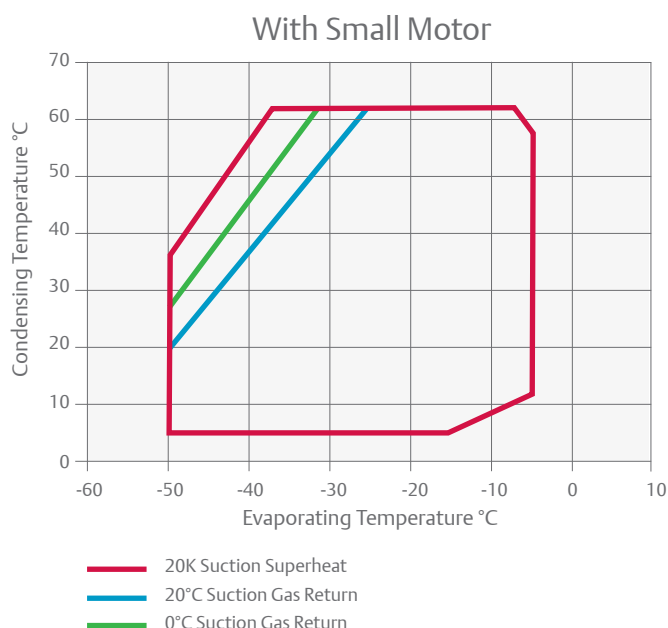

Operating Envelope R407A

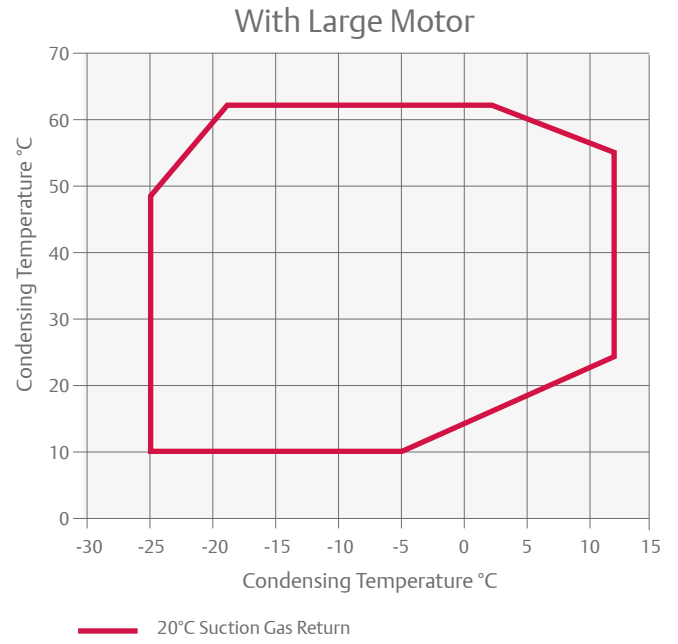
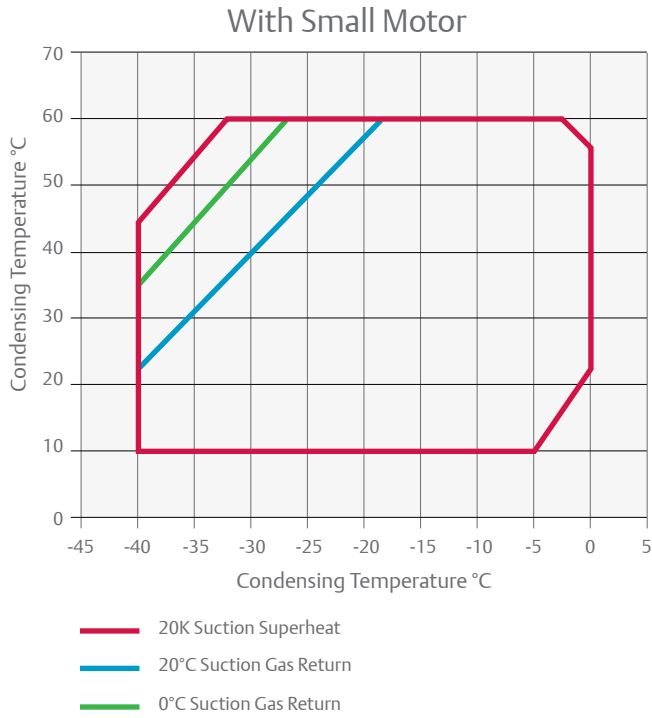

Operating Envelope R407F

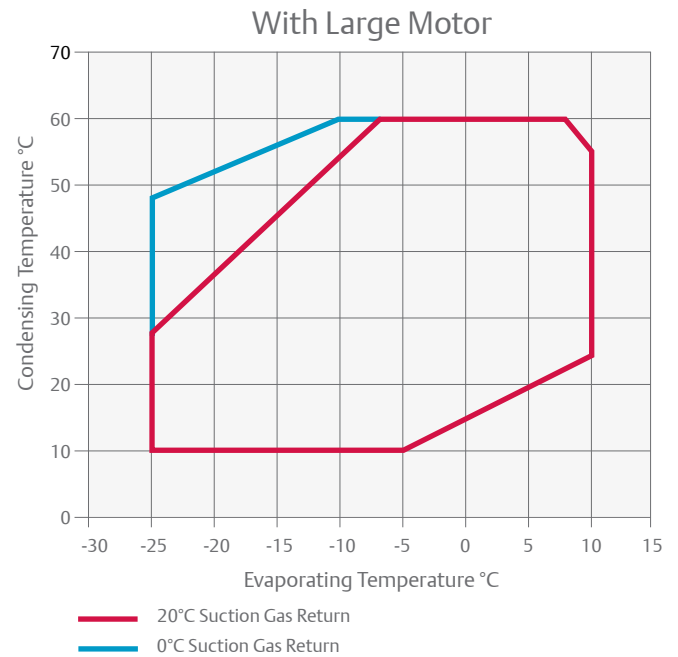
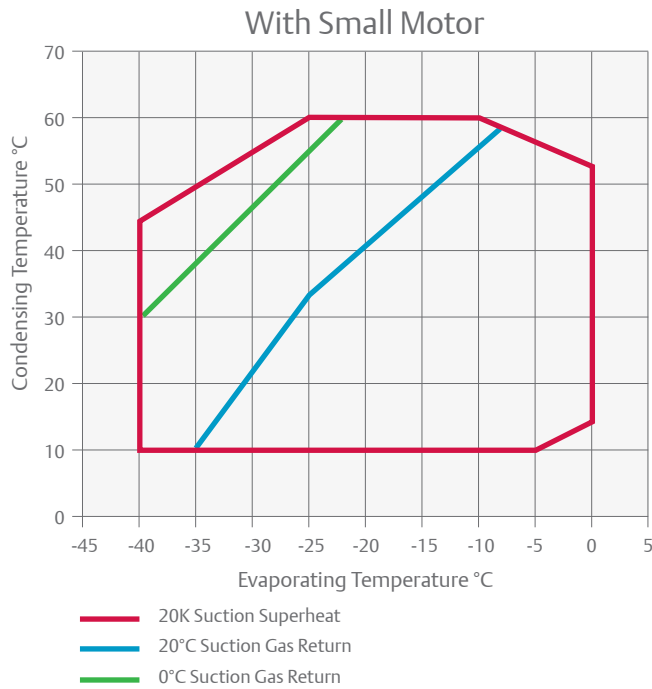

Operating Envelope R448A/R449A

With Small Motor

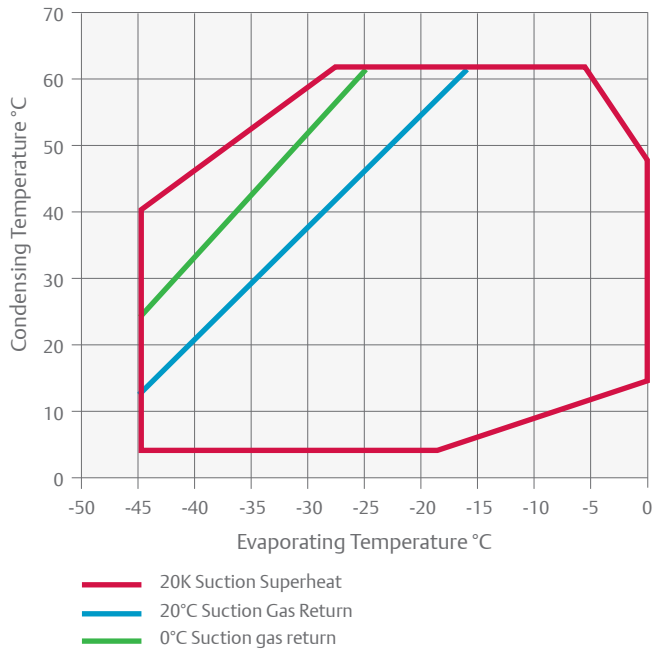

With Large Motor

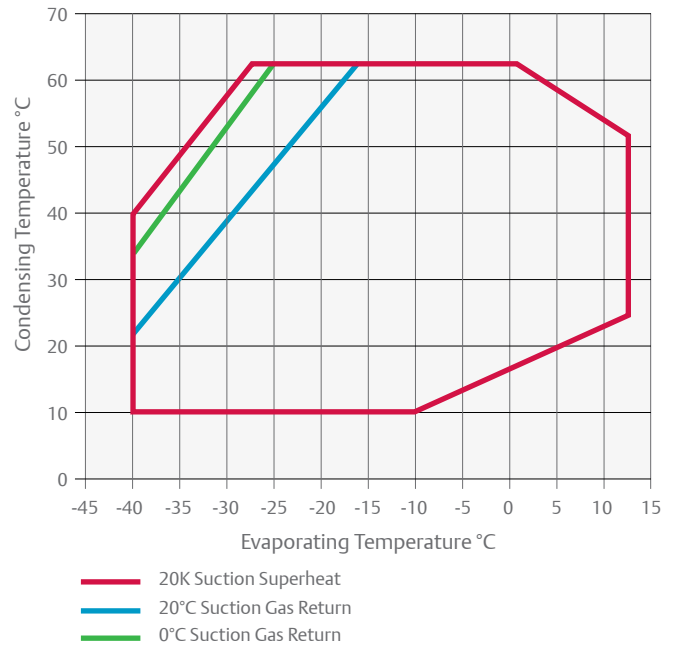

Operating Envelope R134a

With Small Motor

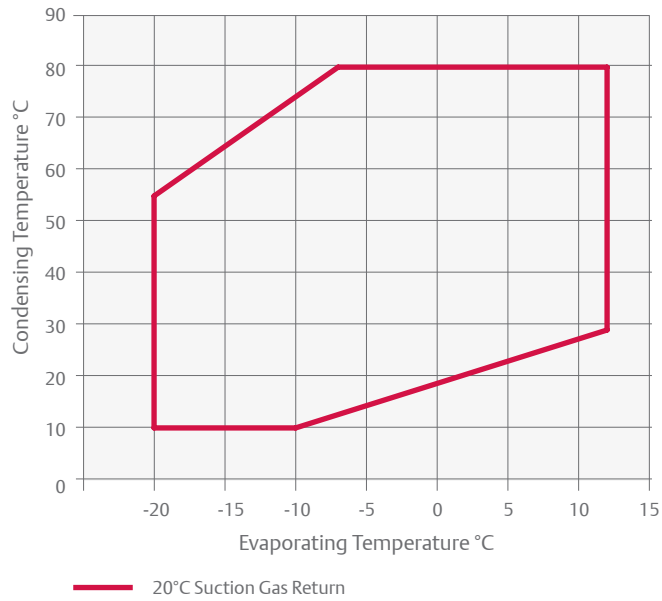

With Large Motor

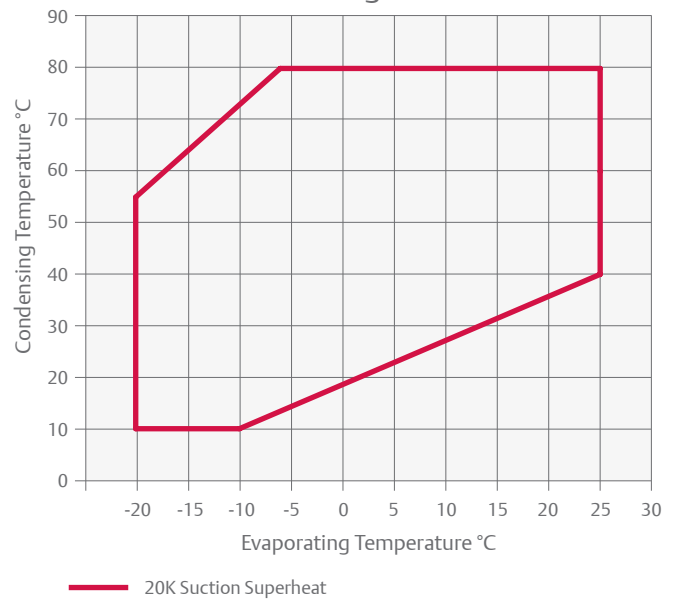

For individual model details please refer to select software.

Technical Overview

Models	Nominal hp	Displacement (m ³ /h)	Oil Quantity (l)	Length/width/height (mm)	Net Weight (kg)	Motor Version/ Code	Maximum Operating Current (A)	Locked Rotor Current (A)	Sound Pressure @ 1 m - dB(A) ***
						3 Ph **	3 Ph **	3 Ph **	
4MF-13X	13	61.7	3.3	638/501/452	177	AWM	30.8	105	70
4MA-22X	22	61.7	3.3	638/501/452	177	AWM	36.3	175	75
4ML-15X	15	71.4	3.3	638/501/452	180	AWM	35.4	156	71
4MH-25X	25	71.4	3.3	657/501/452	187	AWM	41.6	199	75
4MM-20X	17	78.2	3.3	657/501/452	182	AWM	39	175	71
4MI-30X	27	78.2	3.3	657/501/452	188	AWM	46.6	221	75
4MT-22X	22	87.7	3.3	657/501/452	183	AWM	44.5	175	73
4MJ-33X	33	87.7	3.3	657/501/452	190	AWM	52.9	221	74
4MU-25X	25	99.4	3.3	657/501/452	186	AWM	51.9	199	72
4MK-35X	32	99.4	3.3	688/501/452	202	AWM	61.1	255	74
6MM-30X	27	120.5	3.3	695/547/450	215	AWM	59.7	255	78
6MI-40X	35	120.5	3.3	695/547/450	219	AWM	71.4	304	78
6MT-35X	32	135	3.3	725/547/450	221	AWM	67.3	255	77
6MJ-45X	40	135	3.3	725/547/450	223	AWM	81.5	304	79
6MU-40X	40	153	3.3	757/547/450	225	AWM	75.8	306	78
6MK-50X	50	153	3.3	773/547/450	230	AWM	92.9	393	80

** 3 Ph: 380-420V/ 50Hz

*** @ 1m: sound pressure level at 1m distance from the compressor, free field condition

Capacity Data

Condensing Temperature: 40°C															
R407A	Cooling Capacity (kW)							R407A	Power Input (kW)						
	Evaporating Temperature (°C)								Evaporating Temperature (°C)						
Model	-45	-35	-30	-20	-10	-5	+5	Model	-45	-35	-30	-20	-10	-5	+5
4MF-13X		7.1*	10.3*	19.9	31.2	38.3		4MF-13X		6.1*	7.3*	9.7	11.8	12.7	
4MA-22X				20.3	32.6	40.3	59.9	4MA-22X				9.5	11.7	12.6	14
4ML-15X		9.2*	13.0*	24.3	38	46.6		4ML-15X		7.4*	8.8*	11.4	13.8	14.9	
4MH-25X				23.8	37.8	46.7	69.2	4MH-25X				11.4	13.7	14.6	15.9
4MM-20X		10.4*	14.5*	26.7	41.6	51		4MM-20X		8.3*	9.7*	12.7	15.3	16.5	
4MI-30X				26.7	42.1	51.9	76.5	4MI-30X				12.6	15	16.1	17.8
4MT-22X		11.2*	15.5*	28.7	44.7	54.8		4MT-22X		9.4*	11.1*	14.5	17.5	18.9	
4MJ-33X				29.7	46.8	57.7	85.1	4MJ-33X				14.2	17	18.2	20.1
4MU-25X		12.3*	17.3*	32.6	50.9	62.4		4MU-25X		10.6*	12.4*	16.2	19.9	21.6	
4MK-35X				33.5	52.6	64.7	95.1	4MK-35X				16.2	19.5	20.9	23.4
6MM-30X		15.1*	21.2*	39.7	61.9	75.8		6MM-30X		12.6*	14.9*	19.4	23.6	25.5	
6MI-40X				40.8	64.2	79	116.5	6MI-40X				19.3	23.3	25	27.6
6MT-35X		18.4*	25.1*	45.7	71	86.9		6MT-35X		14.5*	16.8*	21.9	26.9	29.1	
6MJ-45X				45.4	71.4	87.9	129.5	6MJ-45X				21.5	26.1	28	31
6MU-40X		20.9*	27.8*	50.3	78.7	96.7		6MU-40X		16.6*	19.0*	24.4	30.1	32.8	
6MK-50X				50.6	79.4	97.6	143.5	6MK-50X				24.4	29.8	32.3	36.4

Suction Gas Return 20°C, Subcooling OK

* Suction Superheat 10K, Subcooling OK

Capacity Data

Condensing Temperature: 40°C															
R407F	Cooling Capacity (kW)							R407F	Power Input (kW)						
	Evaporating Temperature (°C)								Evaporating Temperature (°C)						
Model	-45	-35	-30	-20	-10	-5	+5	Model	-45	-35	-30	-20	-10	-5	+5
4MF-13X		7.8*	11.1*	19.7*	32.5	39.9		4MF-13X		6.5*	7.7*	10.2*	12.4	13.3	
4MA-22X				20.7*	34.8	43	63.8	4MA-22X				10.2*	12.4	13.2	14.4
4MH-25X				24.2*	40.4	49.9	73.8	4MH-25X				11.9*	14.4	15.4	16.8
4ML-15X		9.9*	13.8*	24.2*	39.8	48.9		4ML-15X		7.8*	9.2*	12.0*	14.6	15.7	
4MM-20X		11.0*	15.3*	26.6*	43.5	53.4		4MM-20X		8.7*	10.3*	13.3*	16.0	17.2	
4MI-30X				26.9*	44.4	54.8	80.7	4MI-30X				13.1*	15.8	17.0	18.6
4MT-22X		12.7*	17.4*	29.9*	48.5	59.5		4MT-22X		10.0*	11.7*	15.1*	18.3	19.7	
4MJ-33X				30.2*	49.5	60.9	89.8	4MJ-33X				14.8*	17.8	19.2	21.1
4MU-25X		14.0*	19.3*	33.3*	54.6	66.9		4MU-25X		11.2*	13.2*	17.2*	21.0	22.8	
4MK-35X				33.7*	55.3	68.3	101	4MK-35X				16.8*	20.4	22.1	24.4
6MM-30X		17.2*	23.7*	40.7*	66	80.7		6MM-30X		13.6*	15.8*	20.4*	24.8	26.7	
6MI-40X				41.2*	67.9	83.5	122.5	6MI-40X				20.2*	24.4	26.2	28.9
6MT-35X		19.8*	27.0*	45.8*	74.1	90.4		6MT-35X		15.3*	18.0*	23.1*	28.0	30.3	
6MJ-45X				45.8*	75.2	92.6	136	6MJ-45X				22.9*	27.6	29.7	32.8
6MU-40X		20.1*	27.7*	48.5*	82.7	101.5		6MU-40X		16.9*	19.8*	25.9*	31.7	34.4	
6MK-50X				51.3*	84.5	104	153.5	6MK-50X				25.8*	31.3	33.7	37.5

Suction Gas Return 20°C, Subcooling 0K
 * Suction Superheat 10K, Subcooling 0K

Condensing Temperature 40°C															
R448A/ R449A	Cooling Capacity (kW)							R448A/ R449A	Power Input (kW)						
	Evaporating Temperature (°C)								Evaporating Temperature (°C)						
Model	-45	-35	-30	-20	-10	-5	5	Model	-45	-35	-30	-20	-10	-5	5
4MA-22X		7.8*	11.3*	21.2	34.3	42.7	63.5	4MA-22X		6.2*	7.4*	9.8	11.8	12.6	13.7
4MF-13X	3.8*	8.2*	11.1*	19.6	30.4	37.3		4MF-13X	4.5*	6.3*	7.4*	9.8	12.2	13.1	
4MH-25X		9.4*	13.5*	24.7	39.1	48.0	70.3	4MH-25X		7.6*	8.9*	11.6	14.1	15.1	16.7
4ML-15X	4.3*	10.5*	14.3*	25.2	38.7	47.1		4ML-15X	5.2*	7.6*	8.9*	11.6	14.2	15.4	
4MI-30X		10.8*	15.4*	28.1	44.1	54.0	78.6	4MI-30X		8.2*	9.8*	13.0	15.6	16.7	18.2
4MM-20X	4.9*	11.8*	16.0*	27.8	42.5	51.5		4MM-20X	5.8*	8.5*	9.9*	12.9	15.6	16.9	
4MJ-33X		12.1*	17.0*	30.9	48.7	59.8	87.6	4MJ-33X		9.2*	11.0*	14.5	17.6	18.9	20.6
4MT-22X	5.9*	13.5*	18.2*	31.3	47.7	57.8		4MT-22X	6.6*	9.7*	11.3*	14.6	17.8	19.2	
4MK-35X		13.7*	19.2*	34.7	54.8	67.5	98.9	4MK-35X		10.7*	12.7*	16.7	20.4	22.0	24.4
4MU-25X	6.5*	14.3*	19.5*	34.2	53.2	65.1		4MU-25X	7.4*	10.8*	12.7*	16.6	20.5	22.4	
6MI-40X		17.1*	23.9*	42.8	66.6	81.4	118.0	6MI-40X		13.0*	15.3*	19.6	23.5	25.2	28.0
6MM-30X	6.6*	17.6*	24.1*	41.8	63.2	76.3		6MM-30X	8.8*	13.1*	15.4*	19.9	23.9	25.6	
6MT-35X	7.5*	19.8*	26.9*	46.5	70.0	84.3		6MT-35X	9.7*	14.6*	17.2*	22.2	26.9	29.0	
6MJ-45X		19.5*	27.2*	48.1	74.5	91.0	132.0	6MJ-45X		14.3*	17.0*	22.2	26.9	28.8	31.7
6MK-50X		21.1*	29.4*	52.7	82.2	101.0	147.0	6MK-50X		16.4*	19.2*	25.0	30.3	32.7	36.7
6MU-40X	8.3*	22.2*	30.5*	53.4	81.8	99.4		6MU-40X	10.9*	16.3*	19.1*	24.6	29.8	32.1	

Suction Gas Return 20°C / Subcooling 0K
 *Suction Superheat 10K, Subcooling 0K
 Preliminary Data

Capacity Data

Condensing Temperature: 40°C															
R404A	Cooling Capacity (kW)							R404A	Power Input (kW)						
	Evaporating Temperature (°C)								Evaporating Temperature (°C)						
Model	-45	-35	-30	-20	-10	-5	+5	Model	-45	-35	-30	-20	-10	-5	+5
4MA-22X		10.5	14.3	23.6	36.0	43.5	62.0	4MA-22X		7.3	8.6	11.0	13.0	13.7	14.7
4MF-13X	3.6*	10.7	14.0	22.8	34.8	42.2		4MF-13X	5.0*	7.4	8.7	11.0	13.0	13.9	
4MH-25X		12.4	16.7	27.5	42.2	51.3	73.6	4MH-25X		8.6	10.1	13.0	15.4	16.3	17.5
4ML-15X	4.8*	13.3	17.4	27.9	42.0	50.8		4ML-15X	6.3*	9.0	10.5	13.3	15.8	16.7	
4MI-30X		14.4	19.4	31.2	46.8	56.3	79.5	4MI-30X		9.8	11.5	14.5	17.0	18	19.5
4MM-20X	5.7*	15.1	19.6	30.9	46.1	55.4		4MM-20X	7.1*	10.1	11.6	14.6	17.0	18.2	
4MJ-33X		16.2	21.4	34.6	52.4	63.4	90.4	4MJ-33X		10.9	12.6	16.0	19.0	20.2	21.8
4MT-22X	6.7*	17.0	21.9	34.7	52.0	62.7		4MT-22X	8.0*	11.5	13.2	16.6	19.5	20.7	
4MK-35X		18.3	24.0	38.8	58.9	71.3	102.0	4MK-35X		12.6	14.6	18.5	22.0	23.5	25.7
4MU-25X	7.2*	18.6	24.1	38.5	58.1	70.2		4MU-25X	9.0*	12.9	14.9	18.8	22.3	23.7	
6MI-40X		21.9	28.9	46.7	70.8	85.8	122.5	6MI-40X		15.2	17.6	22.2	26.1	27.7	30.1
6MM-30X	8.9*	22.7	29.3	46.5	70.2	85.1		6MM-30X	11.0*	15.7	18.0	22.5	26.3	27.8	
6MJ-45X		24.3	32.3	52.5	79.5	96.1	136.5	6MJ-45X		16.8	19.6	24.9	29.5	31.4	33.9
6MT-35X	10.3*	25.6	33	52.5	79.3	95.9		6MT-35X	12.3*	17.5	20.1	25.3	29.7	31.5	
6MK-50X		27.3	36.3	58.7	88.6	107.0	152.0	6MK-50X		19.4	22.5	28.3	33.5	35.9	39.9
6MU-40X	11.0*	28.4	36.8	58.7	89.0	108.0		6MU-40X	13.8*	19.7	22.7	28.5	33.6	35.8	

Suction Gas Return 20°C, Subcooling 0K
 * Suction superheat 10K, Subcooling 0K

Condensing Temperature: 40°C															
R134a	Cooling Capacity (kW)							R134a	Power Input (kW)						
	Evaporating Temperature (°C)								Evaporating Temperature (°C)						
Models	-45	-35	-30	-20	-10	-5	+5	Models	-45	-35	-30	-20	-10	-5	+5
4MA-22X				13.1	21.3	26.6	40.1	4MA-22X				5.9	7.3	7.9	8.7
4MF-13X				12.2	20.4	25.6	38.9	4MF-13X				5.8	7.2	7.8	8.7
4MH-25X				15.0	24.6	30.7	46.4	4MH-25X				7.0	8.7	9.4	10.4
4ML-15X				15.0	24.5	30.5	46.0	4ML-15X				6.9	8.5	9.3	10.4
4MI-30X				16.8	27.1	33.7	50.7	4MI-30X				7.6	9.4	10.3	11.4
4MM-20X				16.6	27.0	33.6	50.3	4MM-20X				7.7	9.4	10.2	11.4
4MJ-33X				18.9	30.3	37.6	56.4	4MJ-33X				8.7	10.7	11.5	12.8
4MT-22X				19.0	30.6	38.1	57.2	4MT-22X				8.7	10.8	11.7	13.0
4MK-35X				21.0	34.0	42.2	63.3	4MK-35X				9.7	12.2	13.3	14.9
4MU-25X				20.7	33.9	42.3	63.8	4MU-25X				9.8	12.2	13.3	15.0
6MI-40X				24.8	40.2	50.2	76.0	6MI-40X				12.0	14.6	15.8	17.8
6MM-30X				25.2	40.7	50.7	76.1	6MM-30X				11.7	14.6	15.8	17.7
6MJ-45X				28.5	45.6	56.7	85.3	6MJ-45X				13.0	16.2	17.8	20.3
6MT-35X				28.5	46.0	57.1	85.2	6MT-35X				13.3	16.5	17.9	20.0
6MK-50X				29.8	49.1	61.7	94.3	6MK-50X				15.2	18.8	20.5	23.3
6MU-40X				31.5	50.6	62.9	94.5	6MU-40X				14.6	18.4	20.1	23.0

Suction Gas Return 20°C, Subcooling 0K
 * Suction Superheat 10K, Subcooling 0K

Copeland™ Stream Digital With CoreSense™ Diagnostics for Continuous Capacity Modulation

Stream Digital series 4 and 6 cylinder compressors provide an alternative means of continuous modulation to inverter. Digital modulation is the most simple and precise method of capacity control and helps to contain applied costs associated with modulation.

Digital technology is based on controlling a high-cycle solenoid valve fitted on one of the cylinder heads based on cycle time. The valve actuates a piston that controls the flow of gas into the suction area of the Stream valve plate.

The compressor always runs at constant speed which resolves the challenges related to oil return, mechanical and electrical stress on the system.

All compressors are equipped with CoreSense technology and offer the possibility to diagnose system-related problems faster or even before they occur.



Copeland Stream Digital Compressor

Stream Digital Line-Up

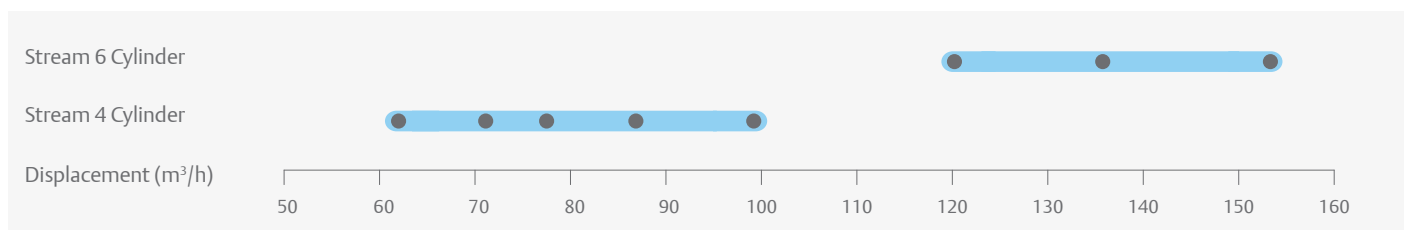

Features and Benefits

- Range of 16 Models from 62 to 153 m³/h
- Multi-refrigerant compressor as it is compatible with R407A/ F/C, R448A/ R449A, R404A, R134a, R450A and R513A
- Continuous modulation from 50–100% (4-cylinder) and 33–100% (6-cylinder) ensuring a perfect match of capacity and power to refrigeration load
- Economical and reliable alternative to frequency inverters
- Precise suction pressure control with associated energy savings and stable evaporating temperatures
- Quick and easy integration into refrigeration equipment, similar to any other standard compressor
- Possibility to easily retrofit existing installations with digital cylinder head kit
- No vibrations or mechanical stress on system piping and compressor parts
- Reduced compressor cycling for longer contactor and compressor life
- Emerson CoreSense Diagnostics technology providing advanced protection, diagnostics and preventive maintenance
- CoreSense Protection available as option

Operating Envelope R448A/R449A

With 4 Cylinder Small Motor - 100% Modulation

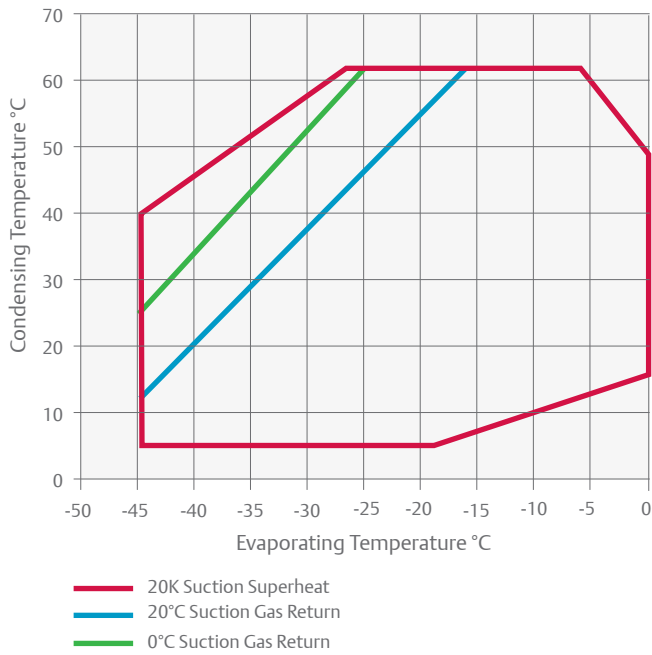

With 6 Cylinder Large Motor - 100% Modulation

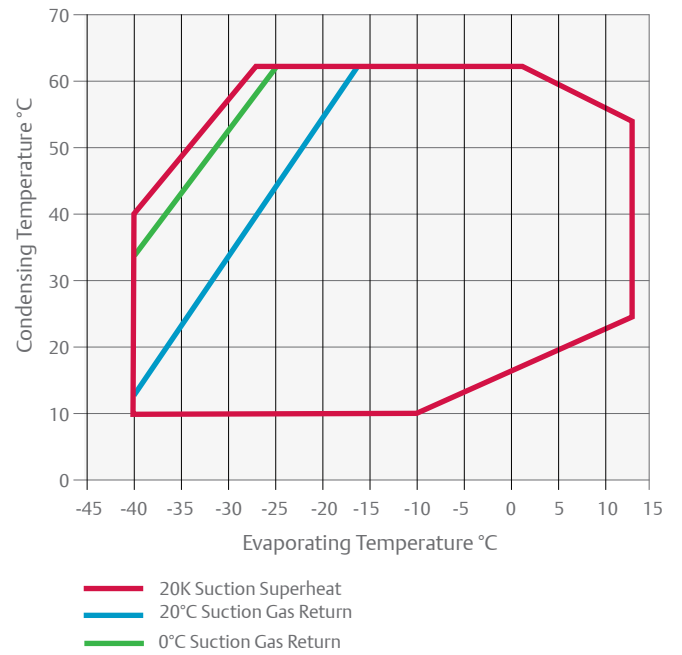

With 4 Cylinder Small Motor - 50% Modulation

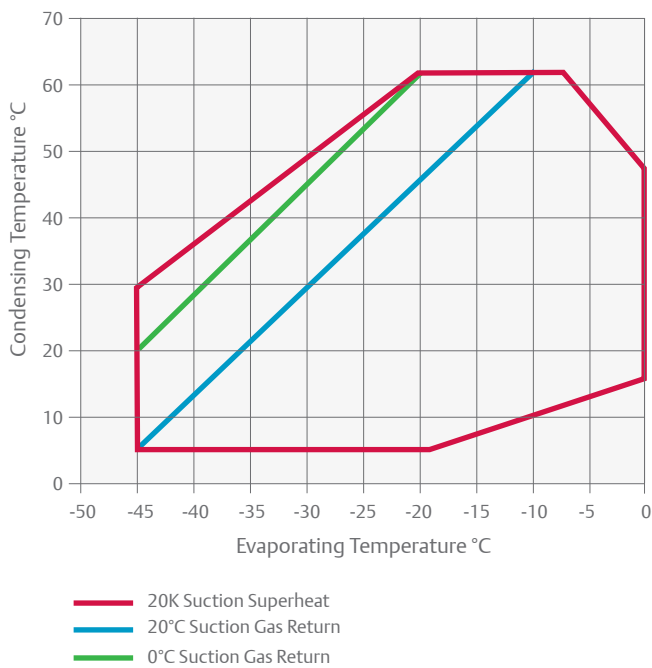

With 6 Cylinder Large Motor - 33% Modulation

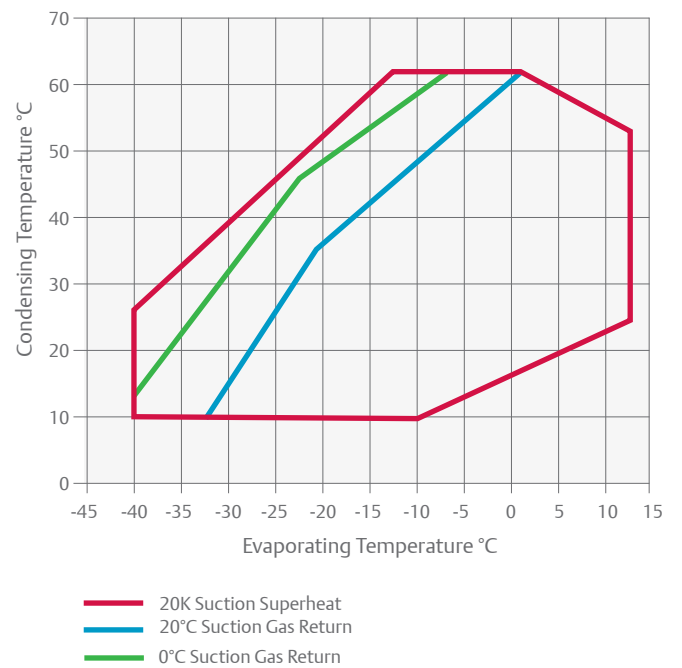

All other refrigerant envelopes are available as 'Dynamic Envelopes' and can be accessed through select software.

Technical Overview

Models	Nominal hp	Displacement (m ³ /h)	Oil Quantity (l)	Length/Width/Height (mm)	Net Weight (kg)	Motor Version/Code	Maximum Operating Current (A)	Locked Rotor Current (A)	Sound Pressure @1 m - dB(A) ***
						3 Ph **	3 Ph **	3 Ph **	
4MFD-13X	13	61.7	3.3	638/501/452	183	AWM	30.8	105	70
4MAD-22X	22	61.7	3.3	638/501/452	183	AWM	36.3	175	75
4MLD-15X	15	71.4	3.3	638/501/452	186	AWM	35.4	156	71
4MHD-25X	25	71.4	3.3	657/501/452	193	AWM	41.6	199	75
4MMD-20X	17	78.2	3.3	657/501/452	188	AWM	39.0	175	71
4MID-30X	27	78.2	3.3	657/501/452	194	AWM	46.6	221	75
4MTD-22X	22	87.7	3.3	657/501/452	189	AWM	44.5	175	73
4MJD-33X	33	87.7	3.3	657/501/452	196	AWM	52.9	221	74
4MUD-25X	25	99.4	3.3	657/501/452	192	AWM	51.9	199	72
4MKD-35X	32	99.4	3.3	688/501/452	202	AWM	61.1	255	74
6MMD-30X	27	120.5	3.3	695/547/450	221	AWM	59.7	255	78
6MID-40X	35	120.5	3.3	695/547/450	225	AWM	71.4	304	78
6MTD-35X	32	135.0	3.3	725/547/450	227	AWM	67.3	255	77
6MJD-45X	40	135.0	3.3	725/547/450	229	AWM	81.5	304	79
6MUD-40X	40	153.0	3.3	757/547/450	231	AWM	75.8	304	78
6MKD-50X	50	153.0	3.3	773/547/450	236	AWM	92.9	393	80

** 3 Ph: 380-420V/ 50Hz

*** @ 1m: sound pressure level at 1m distance from the compressor, free field condition

Capacity Data

Condensing Temperature: 40°C															
R407A	Cooling Capacity (kW)							R407A	Power Input (kW)						
	Evaporating Temperature (°C)								Evaporating Temperature (°C)						
Model	-45	-35	-30	-20	-10	-5	+5	Model	-45	-35	-30	-20	-10	-5	+5
4MFD-13X				18.3*	30.9	37.9		4MFD-13X				9.7*	11.8	12.7	
4MAD-22X					32.2	39.9	59.3	4MAD-22X					11.7	12.6	14.0
4MLD-15X				22.7*	37.7	46.1		4MLD-15X				11.4*	13.8	14.9	
4MHD-25X					37.4	46.2	68.5	4MHD-25X					13.7	14.6	15.9
4MMD-20X				24.9*	41.2	50.5		4MMD-20X				12.7*	15.3	16.5	
4MID-30X				21.6*	37.4	46.2	68.5	4MID-30X				11.4*	13.7	14.6	15.9
4MTD-22X				26.5*	44.2	54.2		4MTD-22X				14.5*	17.5	18.9	
4MJD-33X					41.7	51.4	75.7	4MJD-33X					15.1	16.1	17.8
4MUD-25X				30.1*	50.4	61.8		4MUD-25X				16.2*	19.9	21.6	
4MKD-35X					52.1	64.1	94.2	4MKD-35X					19.5	20.9	23.4
6MMD-30X			20.9*	39.3	61.3	75.0		6MMD-30X			14.9*	19.4	23.6	25.5	
6MID-40X				40.4	63.6	78.3	115.5	6MID-40X				19.3	23.3	25.0	27.6
6MTD-35X			24.8*	45.3	70.3	86.0		6MTD-35X			16.8*	21.9	26.9	29.1	
6MJD-45X				45.0	70.7	87.0	128.0	6MJD-45X				21.5	26.1	28.0	31.0
6MUD-40X				50.4	78.7	96.7		6MUD-40X				24.4	30.1	32.8	
6MKD-50X				50.1	78.6	96.6	142.0	6MKD-50X				24.4	29.8	32.3	36.4

Suction Gas Return 20°C, Subcooling 0K, 100% Loaded

* Suction Superheat 10K, Subcooling 0K

Condensing Temperature: 40°C															
R407F	Cooling Capacity (kW)							R407F	Power Input (kW)						
	Evaporating Temperature (°C)								Evaporating Temperature (°C)						
Model	-45	-35	-30	-20	-10	-5	+5	Models	-45	-35	-30	-20	-10	-5	+5
4MAD-22X				20.5*	34.4	42.6	63.1	4MAD-22X				10.2*	12.4	13.2	14.4
4MFD-13X				19.5*	32.2	39.5		4MFD-13X				10.2*	12.4	13.3	
4MHD-25X				23.9*	40.0	49.4	73.1	4MHD-25X				11.9*	14.4	15.4	16.8
4MLD-15X				23.9*	39.4	48.4		4MLD-15X				12.0*	14.6	15.7	
4MID-30X				26.6*	44.0	54.2	79.9	4MID-30X				13.1*	15.8	17.0	18.6
4MMD-20X				26.3*	43.0	52.9		4MMD-20X				13.3*	16.0	17.2	
4MJD-33X				29.8*	49.0	60.3	88.9	4MJD-33X				14.8*	17.8	19.2	21.1
4MTD-22X				29.5*	48.0	58.9		4MTD-22X				15.1*	18.3	19.7	
4MKD-35X				33.3*	54.8	67.6	100.0	4MKD-35X				16.8*	20.4	22.0	24.4
4MUD-25X				32.9*	54.0	66.3		4MUD-25X				17.1*	21.0	22.8	
6MID-40X				40.7*	67.2	82.6	121.5	6MID-40X				20.2*	24.4	26.2	28.9
6MMD-30X				40.2*	65.4	79.9		6MMD-30X				20.4*	24.8	26.7	
6MJD-45X				45.3*	74.5	91.6	135.0	6MJD-45X				22.9*	27.6	29.7	32.8
6MTD-35X				45.3*	73.3	89.5		6MTD-35X				23.1*	28.0	30.3	
6MKD-50X				50.7*	83.7	103.0	151.5	6MKD-50X				25.8*	31.3	33.7	37.5
6MUD-40X				47.9*	81.9	100.5		6MUD-40X				25.9*	31.7	34.4	

Suction Gas Return 20°C, Subcooling 0K, 100% Loaded

* Suction Superheat 10K, Subcooling 0K

Preliminary Data

Capacity Data

Condensing Temperature: 40°C															
R404A		Cooling Capacity (kW)						R404A		Power Input (kW)					
		Evaporating Temperature (°C)								Evaporating Temperature (°C)					
Model	-45	-35	-30	-20	-10	-5	+5	Model	-45	-35	-30	-20	-10	-5	+5
4MAD-22X		8.1*	11.7*	23.4	35.6	43.1	61.3	4MAD-22X		7.3*	8.6*	11.0	13.0	13.7	14.7
4MFD-13X		8.3*	11.5*	22.6	34.5	41.8		4MFD-13X		7.4*	8.7*	11.0	13.1	13.9	
4MHD-25X		9.6*	13.7*	27.2	41.7	50.7	72.9	4MHD-25X		8.6*	10.1*	13.0	15.4	16.3	17.5
4MLD-15X		10.6*	14.5*	27.6	41.6	50.2		4MLD-15X		9.0*	10.5*	13.3	15.8	16.7	
4MID-30X		11.4*	16.2*	30.9	46.3	55.7	78.7	4MID-30X		9.8*	11.5*	14.5	17.0	18.0	19.5
4MMD-20X		12.2*	16.4*	30.6	45.6	54.8		4MMD-20X		10.1*	11.6*	14.6	17.1	18.2	
4MJJD-33X		12.9*	17.8*	34.2	51.9	62.7	89.5	4MJJD-33X		10.9*	12.6*	16.1	19.0	20.2	21.8
4MTD-22X		13.7*	18.4*	34.3	51.5	62.1		4MTD-22X		11.5*	13.2*	16.6	19.5	20.7	
4MKD-35X		14.5*	20.0*	38.4	58.3	70.6	101.0	4MKD-35X		12.6*	14.6*	18.5	22.0	23.5	25.7
4MUD-25X		14.9*	20.1*	38.1	57.5	69.5		4MUD-25X		12.9*	14.9*	18.8	22.3	23.7	
6MID-40X		17.3*	28.6°	46.2	70.1	84.9	121.5	6MID-40X		15.2*	17.6°	22.2	26.1	27.7	30.1
6MMD-30X		18.2*	29.0°	46.0	69.5	84.3		6MMD-30X		15.7*	18.1°	22.5	26.3	27.8	
6MJJD-45X		19.2*	32.0°	51.9	78.7	95.1	135.0	6MJJD-45X		16.8*	19.6°	24.9	29.5	31.4	33.9
6MTD-35X		20.5*	32.7°	52.0	78.5	94.9		6MTD-35X		17.5*	20.1°	25.3	29.7	31.5	
6MKD-50X		21.4*	36.0°	58.1	87.7	106.0	150.5	6MKD-50X		19.4*	22.5°	28.3	33.5	35.9	39.9
6MUD-40X		22.6*	36.5°	58.1	88.1	107.0		6MUD-40X		19.7*	22.7°	28.5	33.6	35.8	

Suction Gas Return 20°C, Subcooling 0K, 100% Loaded

* Suction Superheat 10K, Subcooling 0K

° Additional Cooling Required

Condensing Temperature: 40°C															
R134a		Cooling Capacity (kW)						R134a		Power Input (kW)					
		Evaporating Temperature (°C)								Evaporating Temperature (°C)					
Model	-45	-35	-30	-20	-10	-5	+5	Model	-45	-35	-30	-20	-10	-5	+5
4MAD-22X		4.0*	6.2*	11.8*	20.0*	25.4*	39.7	4MAD-22X		3.7*	4.4*	5.9*	7.3*	7.9*	8.7
4MFD-13X				12.1	20.2	25.4	38.5	4MFD-13X				5.8	7.2	7.8	8.7
4MHD-25X		4.4*	6.9*	13.5*	23.1*	29.3*	45.9	4MHD-25X		4.7*	5.4*	7.1*	8.7*	9.4*	10.4
4MLD-15X				14.8	24.2	30.2	45.5	4MLD-15X				6.9	8.5	9.3	10.4
4MID-30X		5.2*	8.0*	15.1*	25.4*	32.2*	50.2	4MID-30X		4.9*	5.8*	7.6*	9.4*	10.3*	11.4
4MMD-20X				16.5	26.7	33.3	49.8	4MMD-20X				7.7	9.4	10.2	11.4
4MJJD-33X		6.0*	9.1*	17.0*	28.5*	35.9*	55.9	4MJJD-33X		5.6*	6.6*	8.7*	10.7*	11.5*	12.8
4MTD-22X				18.9	30.3	37.7	56.7	4MTD-22X				8.7	10.8	11.7	13.1
4MKD-35X		7.0*	10.4*	19.1*	31.9*	40.3*	62.7	4MKD-35X		7.1*	7.7*	9.7*	12.2*	13.3*	14.9
4MUD-25X				20.5	33.5	41.9	63.2	4MUD-25X				9.8	12.2	13.3	15.1
6MID-40X				22.2*	37.6*	47.8*	75.3	6MID-40X				12.0*	14.6*	15.8*	17.8
6MMD-30X				24.9	40.3	50.2	75.3	6MMD-30X				11.7	14.6	15.8	17.7
6MJJD-45X				25.6*	42.7*	54.0*	84.5	6MJJD-45X				13.0*	16.2*	17.8*	20.3
6MTD-35X				28.2	45.5	56.5	84.4	6MTD-35X				13.3	16.5	17.9	20.0
6MKD-50X				26.2*	45.7*	58.6*	93.4	6MKD-50X				15.2*	18.8*	20.5*	23.3
6MUD-40X				31.2	50.1	62.3	93.6	6MUD-40X				14.6	18.4	20.1	23.0

Suction Gas Return 20°C, Subcooling 0K, 100% Loaded

* Suction Superheat 10K, Subcooling 0K

Capacity Data

Condensing Temperature: 40°C															
R448A / R449A	Cooling Capacity (kW)							R448A / R449A	Power Input (kW)						
	Evaporating Temperature (°C)								Evaporating Temperature (°C)						
Model	-45	-35	-30	-20	-10	-5	+5	Model	-45	-35	-30	-20	-10	-5	+5
4MAD-22X		7.7*	11.1*	21.0	34.0	42.2	62.9	4MAD-22X		6.2*	7.4*	9.8	11.8	12.6	13.7
4MFD-13X	3.7*	8.1*	10.9*	19.4	30.1	36.9		4MFD-13X	4.5*	6.3*	7.4*	9.8	12.2	13.1	
4MLD-15X	4.2*	10.3*	14.2*	24.9	38.3	46.6		4MLD-15X	5.2*	7.6*	8.9*	11.6	14.2	15.4	
4MHD-25X		9.3*	13.3*	24.5	38.7	47.6	69.6	4MHD-25X		7.6*	8.9*	11.6	14.1	15.1	16.7
4MMD-20X	4.9*	11.6*	15.8*	27.5	42.0	51.0		4MMD-20X	5.8*	8.5*	9.9*	12.9	15.6	16.9	
4MID-30X		10.6*	15.3*	27.8	43.6	53.5	77.8	4MID-30X		8.2*	9.8*	13.0	15.6	16.7	18.2
4MJD-33X		11.9*	16.8*	30.6	48.2	59.2	86.7	4MJD-33X		9.2*	11.0*	14.5	17.6	18.9	20.6
4MTD-22X	5.8*	13.3*	17.9*	31.0	47.2	57.2		4MTD-22X	6.6*	9.7*	11.3*	14.6	17.8	19.2	
4MKD-35X		13.6*	19.0*	34.4	54.3	66.8	97.9	4MKD-35X		10.7*	12.7*	16.7	20.4	22.0	24.4
4MUD-25X	6.4*	14.2*	19.2*	33.9	52.7	64.4		4MUD-25X	7.4*	10.8*	12.7*	16.6	20.5	22.4	
6MID-40X		16.9*	23.7*	42.4	65.9	80.6	116.5	6MID-40X		13.0*	15.3*	19.6	23.5	25.2	28.0
6MMD-30X	6.5*	17.4*	23.8*	41.4	62.6	75.5		6MMD-30X	8.8*	13.1*	15.4*	19.9	23.9	25.6	
6MTD-35X	7.4*	19.5*	26.6*	46.0	69.3	83.5		6MTD-35X	9.7*	14.6*	17.2*	22.2	26.9	29.0	
6MJD-45X		19.3*	26.9*	47.6	73.7	90.1	131.0	6MJD-45X		14.3*	17.0*	22.2	26.9	28.8	31.7
6MKD-50X		20.8*	29.1*	52.2	81.4	99.8	145.5	6MKD-50X		16.4*	19.2*	25.0	30.3	32.7	36.7
6MUD-40X	8.2*	21.9*	30.2*	52.9	81.0	98.4		6MUD-40X	10.9*	16.3*	19.1*	24.6	29.8	32.1	

Conditions: Suction Gas Return 20°C / Subcooling 0K, 100% Loaded

*Conditions: Suction Superheat 10K, Subcooling 0K

Preliminary Data

Copeland™ Stream Compressors With CoreSense™ Diagnostics for R744-Transcritical Applications

Stream series of 4 cylinder CO₂ compressors is the ideal solution for R744 booster systems. It is characterized by a design pressure of 135 bar. Refrigerant flow and heat transfer have been optimized for best performance. All compressors are equipped with CoreSense technology and offer the possibility to diagnose system-related problems faster or even before they occur.



Copeland Stream Compressors for R744 Refrigeration Designed for Durability and Best-in-Class Performance in R744-Transcritical Applications

Stream Compressor Line-up

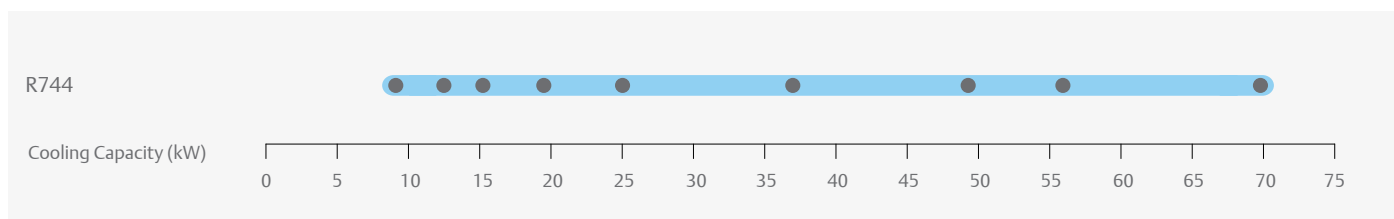

Conditions: EN12900 R744: Evaporating -10°C, gas cooler exit: 35°C/ 90 bar, superheat: 10K

Features and Benefits

Stream provides for flexibility in pack design and operation:

- Compact dimensions
- Integrated low pressure relief valve
- Discharge temperature protection
- Service valve 360° rotation for ease of piping design
- 2 sight glasses for mounting of oil management control and visual inspection
- One oil port for oil equalization in parallel system
- Oil splasher system ensuring lubrication at constant and variable speed

Designed for durability and performance in R744 applications:

- Low sound, low vibration and large discharge chamber to eliminate pulsation
- High design pressures of 135 bar (high side) and 90 bar (low side)
- Burst pressures in excess of safety factor 3
- Cylinder head and discharge plenum design minimizing heat transfer to suction side
- Stepless capacity modulation via inverter from 25 to 70Hz
- CoreSense™ Diagnostics
- Individual compressor power consumption monitoring
- CoreSense Protection available as option

Operating Envelope R744

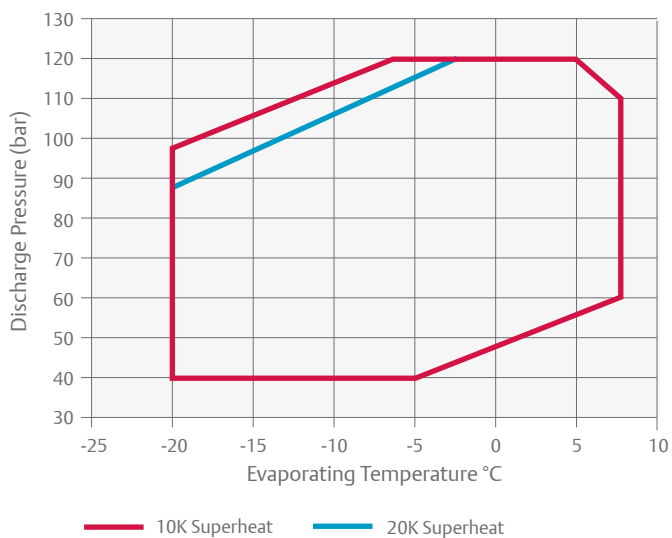

Technical Overview

Model	Nominal hp	Displacement (m ³ /h)	Capacity (kw)	COP	Oil Quantity (l)	Length/Width/Height (mm)	Net Weight (kg)	Motor Version/ Code	Maximum Operating Current (A)	Locked Rotor Current (A)	Sound Pressure @1 m - dB(A)***
								3 Ph**	3 Ph**	3 Ph**	
4MTL-05X	5.0	4.6	9.3	1.6	1.5	630/425/410	123.0	EWL	13.3	80.5	59.0
4MTL-07X	7.0	6.2	12.5	1.6	1.5	630/425/410	124.0	EWL	17.5	81.2	62.0
4MTL-09X	9.0	7.4	15.3	1.6	1.5	630/425/410	123.0	EWL	21.0	93.5	63.0
4MTL-12X	12.0	9.5	19.2	1.7	1.8	697/444/423	170.0	AWM	26.5	145.0	67.4
4MTL-15X	15.0	12.5	25.2	1.8	1.8	697/445/422	170.0	AWM	34.8	156.0	71.3
4MTL-30X	30.0	18.0	37.0	1.8	1.8	697/445/422	175.0	AWM	50.0	221.0	75.1
4MTL-35X	35.0	22.7	49.0	1.79	2.5	842/ 468/ 467	257.9	AWM	67.1	304	75.1
4MTL-40X	40.0	26.6	56.0	1.84	2.5	842/ 468/ 467	264.0	AWM	72.6	306	75.1
4MTL-50X	50.0	32.0	70.0	1.81	2.5	842/ 468/ 467	269.4	AWM	90.3	393	75.1

** 3 Ph: 380-420V/ 50Hz

*** @ 1m: Sound Pressure Level at 1m Distance from the Compressor, Free Field Condition

Preliminary Data

Capacity Data

			Cooling Capacity (kW)					Power Input (kW)					
Model	Temperature (°C)	Pressure (bar)	Evaporating Temperature (°C)					Evaporating Temperature (°C)					
			-20	-15	-10	-5	0	-20	-15	-10	-5	0	
			Equivalent Evaporation Pressure (bar)					Equivalent Evaporation Pressure (bar)					
			19.7	22.9	26.5	30.5	34.9	19.7	22.9	26.5	30.5	34.9	
4MTL-05X	Condensing	10	45	10.9	13.4	16.3	19.5		3.1	3.0	2.8	2.5	
		15	50	9.8	12.1	14.8	17.8	21.2	3.4	3.4	3.2	3.0	2.6
		20	57	8.8	10.8	13.2	16.0	19.1	3.8	3.8	3.7	3.5	3.2
		25	64	7.6	9.4	11.5	14.0	16.7	4.1	4.2	4.2	4.0	3.8
		30	75	6.0	7.4	9.2	11.2	13.4	4.5	4.6	4.6	4.6	4.4
	Cool gas	35	90		7.0	8.7	10.7	12.9		5.4	5.6	5.7	5.7
		40	100			7.5	9.3	11.3			6.0	6.2	6.3
		40	110				9.6	11.7				6.6	6.8
4MTL-07X	Condensing	10	45	14.9	18.2	22.1	26.5		3.9	3.7	3.4	3.0	
		15	50	13.5	16.5	20.1	24.1	28.7	4.3	4.3	4.0	3.7	3.2
		20	57	12.0	14.7	17.9	21.7	25.8	4.8	4.8	4.7	4.4	4.0
		25	64	10.4	12.8	15.6	18.9	22.5	5.3	5.4	5.3	5.2	4.9
		30	75	8.2	10.2	12.5	15.1	18.1	5.8	6.0	6.0	5.9	5.7
	Cool gas	35	90		9.5	11.8	14.5	17.4		7.0	7.3	7.4	7.5
		40	100			10.2	12.5	15.1			7.9	8.2	8.3
		40	110				12.9	15.6				8.8	9.0
4MTL-09X	Condensing	10	45	18.3	22.3	27.0	32.4		4.6	4.5	4.1	3.6	
		15	50	16.6	20.3	24.6	29.5	35.0	5.2	5.1	4.9	4.5	3.9
		20	57	14.8	18.2	22.1	26.5	31.5	5.8	5.8	5.6	5.3	4.9
		25	64	12.9	15.8	19.3	23.2	27.6	6.4	6.5	6.4	6.2	5.9
		30	75	10.3	12.6	15.4	18.6	22.1	6.9	7.1	7.2	7.1	6.9
	Cool gas	35	90		11.9	14.7	17.8	21.4		8.5	8.8	9.0	9.0
		40	100			12.7	15.5	18.6			9.5	9.8	10.0
		40	110				16.0	19.3				10.6	10.9
4MTL-12X	Condensing	10	45	24.1	29.1	35.0	41.7		6.1	5.9	5.5	4.9	
		15	50	21.8	26.4	31.9	38.1	45.0	6.8	6.8	6.5	6.0	5.3
		20	57	19.5	23.7	28.6	34.3	40.6	7.6	7.6	7.4	7.0	6.5
		25	64	16.9	20.6	25.0	30.0	35.6	8.3	8.4	8.4	8.2	7.7
		30	75	13.5	16.4	20.0	24.1	28.6	9.0	9.3	9.4	9.3	9.0
	Cool gas	35	90	12.8	15.7	19.3	23.3	27.9	10.2	10.9	11.3	11.6	11.6
		40	100		13.6	16.8	20.4	24.4		11.5	12.2	12.6	12.8
		40	110			17.4	21.2	25.5			12.8	13.5	13.9
4MTL-15X	Condensing	10	45	31.2	37.9	45.6	54.4		7.9	7.6	7.1	6.3	
		15	50	28.3	34.5	41.6	49.7	58.7	8.8	8.7	8.4	7.8	6.9
		20	57	25.3	30.9	37.4	44.8	53.0	9.7	9.7	9.6	9.2	8.6
		25	64	22.0	26.9	32.7	39.3	46.6	10.5	10.8	10.8	10.7	10.2
		30	75	17.5	21.5	26.2	31.6	37.5	11.4	11.8	12.0	12.1	11.8
	Cool gas	35	90	16.5	20.5	25.2	30.5	36.5	13.1	13.8	14.4	14.8	15.0
		40	100		17.7	21.8	26.6	31.8		14.8	15.5	16.1	16.4
		40	110			22.5	27.5	33.1			16.6	17.3	17.9
4MTL-30X	Condensing	10	45	45.6	54.9	65.9	78.3		11.4	11.0	10.4	9.3	
		15	50	41.5	50.2	60.3	71.7	84.4	12.6	12.5	12.1	11.4	10.2
		20	57	37.2	45.1	54.3	64.7	76.3	13.9	14.0	13.9	13.4	12.5
		25	64	32.4	39.4	47.6	56.9	67.2	15.2	15.5	15.6	15.4	14.8
		30	75	25.9	31.6	38.3	45.8	54.2	16.4	16.9	17.3	17.4	17.1
	Cool gas	35	90	24.7	30.3	37.0	44.6	53.1	18.8	19.8	20.6	21.2	21.5
		40	100		26.3	32.2	39.0	46.5		21.2	22.2	23.0	23.6
		40	110			33.4	40.5	48.5			23.8	24.8	25.6

Suction Superheat 10K / Subcooling 0K
Preliminary Data

Capacity Data

			Cooling Capacity (kW)					Power Input (kW)					
Model	Temperature (°C)	Pressure (bar)	Evaporating Temperature (°C)					Evaporating Temperature (°C)					
			-20	-15	-10	-5	0	-20	-15	-10	-5	0	
			Equivalent Evaporation Pressure (bar)					Equivalent Evaporation Pressure (bar)					
			19.7	22.9	26.5	30.5	34.9	19.7	22.9	26.5	30.5	34.9	
4MTL-35X	Condensing	10	45	57.9	69.9	84.2	100.5		14.3	13.7	12.6	11.2	
		15	50	52.6	63.7	76.8	91.9	109.0	15.9	15.6	14.8	13.6	12.0
		20	57	47.1	57.1	69.1	82.8	98.2	17.6	17.6	17.1	16.2	14.9
		25	64	41.1	49.9	60.5	72.6	86.2	19.3	19.6	19.4	18.8	17.8
		30	75	32.8	40.0	48.5	58.4	69.4	20.9	21.5	21.7	21.5	20.8
	Cool gas	35	90	31.5	38.4	46.9	56.7	67.7	23.6	25.1	26.1	26.7	26.9
		40	100		33.5	40.9	49.5	59.3		26.5	28.0	29.1	29.7
	40	110			42.5	51.6	61.9			29.5	31.1	32.1	
4MTL-40X	Condensing	10	45	69.0	83.1	99.7	118.5		16.5	15.9	14.7	13.0	
		15	50	62.8	75.8	91.1	108.5	128.0	18.5	18.2	17.4	16.1	14.1
		20	57	56.4	68.1	81.9	97.9	115.5	20.4	20.4	20.0	19.1	17.6
		25	64	49.3	59.6	71.8	85.9	101.5	22.4	22.7	22.6	22.1	21.1
		30	75	39.5	47.8	57.7	69.1	81.9	24.3	25.0	25.3	25.2	24.6
	Cool gas	35	90	38.1	46.2	55.9	67.2	79.9	28.2	29.4	30.4	31.1	31.4
		40	100		40.3	48.8	58.8	70.0		31.8	33.0	34.1	34.8
	40	110			50.8	61.2	73.1			35.6	36.9	37.9	
4MTL-50X	Condensing	10	45	82.8	99.7	119.5	142.0		20.2	19.6	18.4	16.7	
		15	50	75.6	91.1	109.5	130.5	153.5	22.6	22.3	21.5	20.0	18.0
		20	57	67.9	82.0	98.6	117.5	139.0	24.9	25.1	24.6	23.5	21.9
		25	64	59.5	71.9	86.5	103.5	122.0	27.3	27.8	27.8	27.2	25.9
		30	75	47.7	57.8	69.7	83.4	98.6	29.6	30.6	31.1	30.9	30.1
	Cool gas	35	90	46.2	56.0	67.8	81.4	96.7	33.9	35.9	37.4	38.3	38.6
		40	100		49.0	59.3	71.3	84.8		38.2	40.3	41.8	42.6
	40	110			61.9	74.5	88.8			42.6	44.7	46.2	

Copeland™ Stream Compressors With CoreSense™ Diagnostics for R744-Subcritical Applications Requiring High Standstill Pressures (90bar)

Stream series of 4 cylinder CO₂ compressors is the ideal solution for R744 low temperature cascade and booster systems requiring high standstill pressure of up to 90 bar suction. The use of transcritical compressors in medium / transcritical side as well as on the low temperature / subcritical side ensures that in case of power outage, the refrigeration system features full resilience and no operation disruption.

Stream is characterized by a design pressure of 135 bar. Refrigerant flow and heat transfer have been optimized for best performance. All compressors are equipped with CoreSense technology and offer the possibility to diagnose system-related problems faster or even before they occur.



Copeland Stream compressors for Low Temperature Applications with R744 Designed for durability and best-in-class performance in R744 subcritical applications

Stream Compressor Line-up

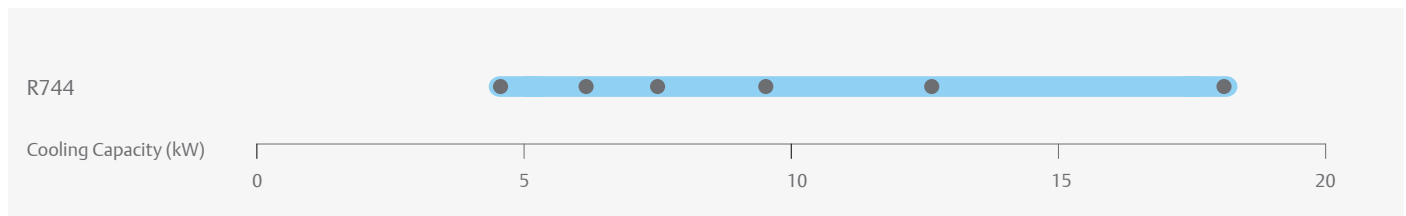

Conditions: EN12900 R744: Evaporating -35°C, condensing -5°C, superheat 10K, subcooling 0K

Features and Benefits

Stream provides for flexibility in pack design and operation:

- Compressor Max. Pressures (Suction/Discharge): 90 bar / 135 bar
- Compact dimensions
- Integrated low pressure relief valve
- Discharge temperature protection
- Service valve 360° rotation for ease of piping design
- 2 sight glasses for mounting of oil management control and visual inspection
- One oil port for oil equalization in parallel system
- Oil splasher system ensuring lubrication at constant and variable speed

Designed for durability and performance in R744 applications:

- Low sound, low vibration and large discharge chamber to eliminate pulsation
- Optimized motor selection for low temperature running conditions
- Burst pressures in excess of safety factor 3
- Cylinder head and discharge plenum design minimizing heat transfer to suction side
- Stepless capacity modulation via inverter from 25 to 70Hz
- CoreSense Diagnostics for advanced protection, diagnostics, communication
- Individual compressor power consumption monitoring
- CoreSense Protection available as option

Operating Envelope R744

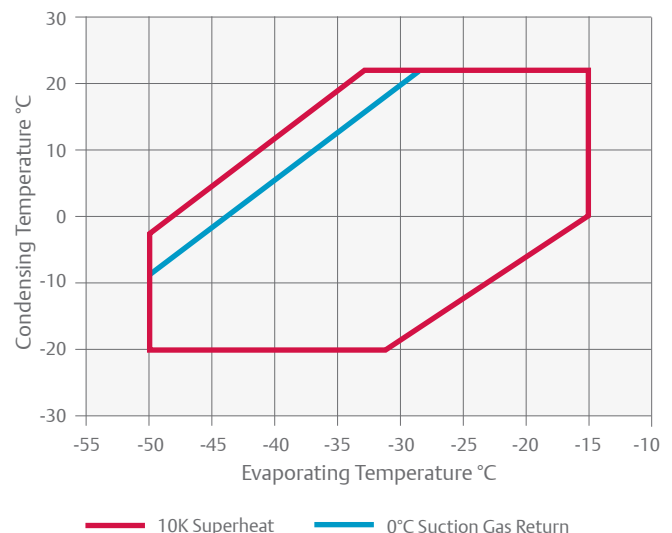

Technical Overview

R744	Nominal hp	Displacement (m ³ /h)	Capacity (kw)	COP	Oil Quantity (l)	Length/Width/Height (mm)	Net Weight (kg)	Motor Version/Code	Maximum Operating Current (A)	Locked Rotor Current (A)	Sound Pressure @1 m - dB(A)***
								3 Ph**	3 Ph**	3 Ph**	
4MSL-03X	3.0	4.6	7.2	3.2	1.5	697/444/423		EWL			76.0
4MSL-04X	4.0	6.2	9.9	3.6	1.5	697/444/423		EWL			76.0
4MSL-06X	5.0	7.4	12.4	3.7	1.5	697/444/423		EWL			76.0
4MSL-08X	8.0	9.5	15.9	3.6	1.8	697/444/423	170.0	AWM	13.9	87.4	76.0
4MSL-12X	12.0	12.5	21.0	3.7	1.8	697/445/422	170.0	AWM	18.7	145.0	76.0
4MSL-15X	15.0	17.9	31.0	3.8	1.8	697/445/422	170.0	AWM	25.7	156.0	76.0

** 3 Ph: 380-420V/ 50Hz

*** @ 1m: sound pressure level at 1m distance from the compressor, free field condition

Capacity Data

R744	Cooling Capacity (kW)				R744	Power Input (kW)			
	Condensing Temperature -10°C					Condensing Temperature -10°C			
	Evaporating Temperature (°C)					Evaporating Temperature (°C)			
Model	-45	-40	-35	-30	Model	-45	-40	-35	-30
4MSL-03X	4.8*	6.3*	8.2*	10.5*	4MSL-03X	1.9*	2.0*	2.0*	1.9*
4MSL-04X	6.7*	8.8*	11.3*	14.2*	4MSL-04X	2.5*	2.6*	2.5*	2.4*
4MSL-06X	8.0*	10.5*	13.5*	16.9*	4MSL-06X	2.9*	3.0*	2.9*	2.7*
4MSL-08X	10.3*	13.5*	17.2*	21.5*	4MSL-08X	3.8*	4.0*	3.9*	3.7*
4MSL-12X	13.8*	17.9*	22.7*	28.4*	4MSL-12X	4.9*	5.0*	5.0*	4.8*
4MSL-15X	20.3*	26.3*	33.4*	41.5*	4MSL-15X	7.0*	7.2*	7.2*	7.0*

Conditions: Suction Gas Return 20°C / Subcooling 0K

*Conditions: Suction Superheat 10K, Subcooling 0K

Preliminary Data

Service Compressors for 4 and 6 Cylinder S-Series and Discus Reciprocating Compressors

With the successful launch of Stream with CoreSense™ Diagnostics 4M and 6M compressors, Emerson has decided to consolidate product families to allow our customers to reduce product proliferation and cost of operation. As a result, Emerson will in the future only produce the most efficient semi-hermetic reciprocating compressor platforms out of its current portfolio.

With a large number of 4 and 6 cylinder S-Series and Discus compressors operating in applications around the world, Emerson recognizes the importance of providing worry-free drop-in replacement models. The range of service compressors offers easy replacement (“like for like”) without the need of system adaptations.

More detailed information is available with our “Guidelines for replacement of S-Series and Discus compressors” available from your Emerson sales office or as download under www.emersonclimate.eu

For your product selection in case of replacement needs, please refer to the cross-reference table below. In addition, our local Application Engineering and Sales team is ready to support you.



Service Compressor*

Discus Replacements

D4DF-100X	→	4MFS1-13X
D4DA-100X	→	4MFS1-13X
D4DA-200X	→	4MAS1-22X
D4DL-150X	→	4MLS1-15X
D4DH-150X	→	4MLS1-15X
D4DH-250X	→	4MHS1-25X
D4DT-220X	→	4MMS1-20X
D4DJ-200X	→	4MMS1-20X
D4DJ-300X	→	4MIS1-30X
D6DL-270X	→	6MLS1-27X
D6DH-200X	→	6MLS1-27X
D6DH-350X	→	6MHS1-35X
D6DT-320X	→	6MMS1-30X
D6DJ-300X	→	6MMS1-30X
D6DJ-400X	→	6MIS1-40X

*Valves are available as optional accessories.



Refrigeration Units

Refrigeration Units

Emerson offers the broadest and most reliable refrigeration unit product line-up. Leveraging the latest compressor technology, each platform provides you the option to select the refrigerant, capacity and application temperature combinations that meet your requirements. A huge variety of Copeland™ indoor and outdoor refrigeration units offer the right solution for applications in food retail and food service, commercial and industrial refrigeration.

Copeland EazyCool™ Scroll Outdoor Refrigeration Units are designed and fully equipped for a quick and easy installation and ideal to integrate into urban environments. The latest scroll technology is combined with high-quality Alco components and covered by a weatherproof housing in a unique design.

The Copeland EazyCool Refrigeration Unit ZX Series offers the highest energy efficiency available in a standard unit to lower operators' utility bills. Ranging in size from 2 to 7.5 hp, the ZX units are perfectly suited for typical food service and retail applications. The key benefits of compactness, silence and efficiency in the standard models will be enhanced by the capability of continuous capacity modulation of the ZX Digital models. This makes ZX Digital refrigeration units the perfect fit for applications with wide load variations.



Copeland Scroll™ indoor refrigeration units are equipped with the latest refrigeration scroll compressors and constitute the widest range of their kind. The modular line concept offers base units which can be adapted to the target application by various options including weather housings and fan speed controls.

Copeland Scroll Digital Receiver Units HLR are an innovative offering for food service and retail businesses. Their compact design and the power of Digital Scroll continuous capacity modulation enable optimized environmental integration with highest system efficiency.

Semi-hermetic refrigeration units: robust, reliable and efficient air-cooled refrigeration unit platforms featuring semi-hermetic reciprocating compressor technology are for use in high-medium- and low-temperature applications. Emerson has expanded its semi-hermetic product range by the innovative Stream Indoor Refrigeration Units. There with we can offer a product range from 0.8 - 40 hp with dedicated refrigerant approvals for R407A/F, R448A/ R449A, R404A, R134a, R450A and R513A.

Copeland EazyCool™ Outdoor Refrigeration Units With Scroll Compressors

Copeland™ air-cooled outdoor refrigeration units for medium-temperature and low-temperature applications.

Emerson has developed this series of refrigeration units especially for outdoor use. The latest Scroll technology is combined with high-quality components and covered by an absolutely weather-resistant synthetic resin housing in a unique design.

The EazyCool line-up offers state-of-the-art technology and models featuring stepless capacity control, vapor injection and fan speed control. This makes it the first choice for target applications in food retail and food service:

- Proximity and convenience stores
- Mini markets and supermarkets
- Bars, restaurants and kitchens
- Beer cellars and beverage coolers



Copeland EazyCool Outdoor Refrigeration Units with Scroll Compressors

EazyCool OLQ/OMQ Line-up

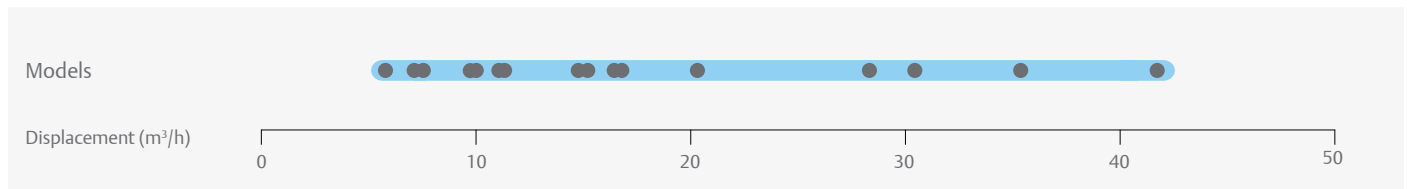

EazyCool Digital Line-up

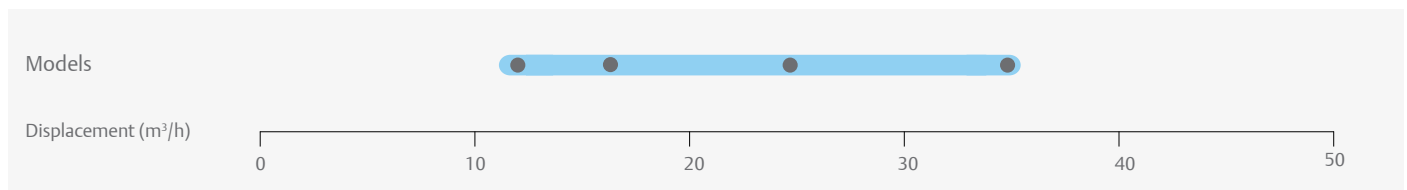

Features and Benefits

- Standard equipment: Scroll compressor(s), crankcase heater(s), condenser with thermally protected fan(s), fan speed control, HP and LP switch, liquid receiver, filter drier & sight glass, weather-resistant housing
- Suitable for multiple refrigerants: R407A/F, R448A/ R449A, R404A, R134a, R450A and R513A.
- Wide range of quality accessories
- Excellent efficiency
- Filter drier, liquid sight glass and solenoid valve in liquid line

Maximum Allowable Pressure (PS)

- Low Side PS 22.5 bar (g)
- High Side PS 28 bar (g)

Technical Overview

Models	Displacement (m ³ /h)	Receiver Capacity (l)	Number of Fans	Total Fan Motor Power (W)	Suction Line Diameter (inch)	Liquid line Diameter (inch)	Width/Depth/Height (mm)	Net Weight (kg)	Motor Version/Code		Maximum Operating Current (A)		Locked Rotor Current (A)		Sound Pressure @10m - dB(A)***
									1 Ph*	3 Ph**	1 Ph*	3 Ph**	1 Ph*	3 Ph**	
Medium Temperature Models															
OMQ-56	11.5	17.7	2	290	1 ³ / ₈	5/8	2100/670/950	224.0		TWD		15		99	44.0
OMTQ-60	13.1	17.7	2	290	1 ³ / ₈	5/8	2100/670/950	209.0		TFD		2x10		2x49	42.0
OMTQ-76	15.1	17.7	2	290	1 ³ / ₈	5/8	2100/670/950	211.0		TFD		2x13		2x66	43.0
OMQ-75	15.3	17.7	2	290	1 ³ / ₈	5/8	2100/670/950	224.0		TWD		22		127	44.0
OMTQ-90	19.9	17.7	2	550	1 ³ / ₈	5/8	2100/670/950	225.0		TFD		2x13		2x74	45.0
OMQ-92	20.5	17.7	2	550	1 ³ / ₈	5/8	2100/670/950	246.0		TWD		25		167	46.0
OMQ-110	23.7	17.7	2	550	1 ⁵ / ₈	5/8	2100/670/950	255.0		TWD		29		198	47.0
Digital Medium Temperature Models															
OMQ-30D	6.2	8.1	1	145	7/8	1/2	1050/630/720	98.0		TFD		8		52	36.0
OMQ-45D	9.4	8.1	1	145	7/8	1/2	1250/642/720	118.0		TFD		12		74	39.0
OMTQ-60D	13.2	17.7	2	290	1 ³ / ₈	5/8	2100/670/950	209.0		TFD		8+10			42.0
OMTQ-90D	20.0	17.7	2	550	1 ³ / ₈	5/8	2100/670/950	225.0		TFD		12+13			45.0
Low Temperature Models															
OLQ-24V	7.2	17.7	2	290	1 ³ / ₈	5/8	2100/670/950	228.0		TWD		16		99	44.0
OLTQ-26V	8.2	17.7	2	550	1 ³ / ₈	5/8	2100/670/950	221.0		TFD		2x9		2x52	42.0
OLQ-33V	9.8	17.7	2	550	1 ³ / ₈	5/8	2100/670/950	228.0		TWD		21		127	44.0
OLQ-40V	11.8	17.7	2	550	1 ³ / ₈	5/8	2100/670/950	238.0		TWD		27		167	46.0
OLTQ-36V	12.1	17.7	2	550	1 ³ / ₈	5/8	2100/670/950	235.0		TFD		2x14		2x74	45.0
OLQ-48V	14.7	17.7	2	550	1 ³ / ₈	5/8	2100/670/950	259.0		TWD		31		198	47.0
Digital Low Temperature Models															
OLQ-18DV	6.1	17.7	2	290	7/8	5/8	2100/670/950	200.0		TFD		14		74	39.0
OLTQ-36DV	12.1	17.7	2	550	1 ³ / ₈	5/8	2100/670/950	235.0		TFD		14+14		2x74	45.0

* 1ph: 230V/ 50Hz

** 3 Ph: 380-420V/ 50Hz

*** @ 10m: sound pressure level at 10m distance from the compressor, free field condition

Capacity Data

Ambient Temperature: 32°C															
R407A	Cooling Capacity (kW)							R407A	Power Input (kW)						
	Evaporating Temperature (°C)								Evaporating Temperature (°C)						
	-45	-35	-30	-20	-10	-5	+5		-45	-35	-30	-20	-10	-5	+5
Medium Temperature Models															
OMQ-56				7.2*	11.1	13.2	17.8	OMQ-56				5.5*	6.1	6.4	7.0
OMQ-75				10.1*	14.6*	17.6	23.2	OMQ-75				7.2*	8.3*	9.1	10.3
OMQ-92				13.1*	19.8	23.3	31.3	OMQ-92				9.0*	10.3	10.9	12.3
OMQ-110				15.2*	22.3*	27.0	36.1	OMQ-110				11.2*	12.8*	13.8	15.6
OMTQ-60				8.3*	13.0	15.5	21.0	OMTQ-60				6.1*	6.8	7.2	8.2
OMTQ-76				9.8*	15.2	17.9		OMTQ-76				7.8*	8.8	9.4	
OMTQ-90				12.4*	19.0	22.5	30.6	OMTQ-90				8.0*	9.3	9.9	11.1
Low Temperature Models															
OLQ-24V		5.8	7.2	10.4	14.3	16.4	21.0	OLQ-24V		4.9	5.3	6.3	8.0	9.2	13.0
OLQ-33V		7.7	9.8	14.5	18.7	20.1	20.4	OLQ-33V		6.4	6.8	7.8	9.3	10.5	13.9
OLQ-40V		10.2	12.6	18.3	24.7	28.0	34.5	OLQ-40V		7.6	8.2	9.8	12.2	13.8	18.1
OLTQ-36V		10.2*	12.2*	17.4*	25.2*	30.6*		OLTQ-36V		8.0*	8.3*	9.1*	10.7*	12.2*	
Digital Medium Temperature Models															
OMQ-30D					5.9*	7.0*		OMQ-30D					3.8*	4.1*	
OMQ-45D					8.6*	10.6		OMQ-45D					4.8*	5.2	
OMTQ-60D				8.3*	13.0	15.5	20.9	OMTQ-60D				6.2*	6.9	7.3	8.3
OMTQ-90D				12.6	18.7	22.3	30.5	OMTQ-90D				8.7	9.5	10.0	11.0
Digital Low Temperature Models															
OLTQ-36DV		10.0*	12.1*	17.3*	25.4*	30.8*		OLTQ-36DV		7.8*	8.1*	9.0*	10.8*	12.3*	

Conditions: EN13215: Suction Gas Return 20°C, Subcooling 0K

* Conditions: EN13215: Suction Superheat 10K

Preliminary Data

Ambient Temperature: 32°C															
R407F	Cooling Capacity (kW)							R407F	Power Input (kW)						
	Evaporating Temperature (°C)								Evaporating Temperature (°C)						
	-45	-35	-30	-20	-10	-5	+5		-45	-35	-30	-20	-10	-5	+5
Medium Temperature Models															
OMTQ-60					12.4*	15.2		OMTQ-60					7.3*	7.7	
OMTQ-76					14.3*	17.2*		OMTQ-76					9.7*	10.3*	
OMTQ-90				11.7*	18.6*	22.9	31.8	OMTQ-90				9.1*	10.3*	10.9	12.2
Digital Medium Temperature Models															
OMQ-30D					6.1*	7.2*		OMQ-30D					3.5*	3.9*	
OMQ-45D					9.1*	11.1		OMQ-45D					5.0*	5.5	
OMTQ-60D					12.6*	15.4		OMTQ-60D					7.0*	7.5	
OMTQ-90D				11.8*	18.9*	23.2	31.7	OMTQ-90D				8.6*	10.0*	10.8	12.4

Conditions: EN13215: Suction Gas Return 20°C, Subcooling 0K

* Conditions: EN13215: Suction Superheat 10K

Preliminary Data

Capacity Data

Ambient Temperature: 32°C															
R448A	Cooling Capacity (kW)							R448A	Power Input (kW)						
	Evaporating Temperature (°C)								Evaporating Temperature (°C)						
	-45	-35	-30	-20	-10	-5	+5		-45	-35	-30	-20	-10	-5	+5
Low Temperature Models															
OLQ-24V		5.7*	7.1*	10.5*	14.8*	17.3*		OLQ-24V		4.8*	5.2*	5.9*	6.6*	7.0*	
OLQ-33V		7.9*	9.8*	14.6*	20.6*	24.1*	32.3	OLQ-33V		6.4*	6.9*	7.7*	8.6*	9.0*	9.9
OLQ-40V		9.5*	12.4*	18.6*	25.7*	29.7*		OLQ-40V		7.6*	8.7*	10.6*	11.9*	12.6*	
Digital Medium Temperature Models															
OMQ-30D				4.1*	6.2	7.3		OMQ-30D				2.9*	3.5	3.9	
OMQ-45D				6.1*	9.5	11.2	14.9	OMQ-45D				3.8*	4.7	5.2	6.2

Conditions: EN13215: Suction Gas Return 20°C, Subcooling 0K

* Conditions: EN13215: Suction Superheat 10K

Preliminary Data

Ambient Temperature: 32°C															
R449A	Cooling Capacity (kW)							R449A	Power Input (kW)						
	Evaporating Temperature (°C)								Evaporating Temperature (°C)						
	-45	-35	-30	-20	-10	-5	+5		-45	-35	-30	-20	-10	-5	+5
Low Temperature Models															
OLQ-24V		5.7*	7.1*	10.5*	14.8*	17.3*		OLQ-24V		4.8*	5.2*	5.9*	6.7*	7.0*	
OLQ-33V		7.9*	9.8*	14.6*	20.6*	24.1*	32.3	OLQ-33V		6.4*	6.9*	7.8*	8.6*	9.0*	9.9
OLQ-40V		9.5*	12.4*	18.6*	25.7*	29.6*		OLQ-40V		7.6*	8.7*	10.6*	12.0*	12.6*	
Digital Medium Temperature Models															
OMQ-30D				4.1*	6.2	7.3		OMQ-30D				2.9*	3.5	3.9	
OMQ-45D				6.1*	9.5	11.2	14.9	OMQ-45D				3.8*	4.7	5.2	6.2

Conditions: EN13215: Suction Gas Return 20°C, Subcooling 0K

* Conditions: EN13215: Suction Superheat 10K

Preliminary Data

Capacity Data

Ambient Temperature: 32°C															
R404A	Cooling Capacity (kW)							R404A	Power Input (kW)						
	Evaporating Temperature (°C)								Evaporating Temperature (°C)						
	-45	-35	-30	-20	-10	-5	+5		-45	-35	-30	-20	-10	-5	+5
Medium Temperature Models															
OMQ-56				8.3	11.5	13.4	17.4	OMQ-56				6.2	6.7	6.9	7.5
OMQ-75				11.3	15.3	17.4	22.1	OMQ-75				8.2	9.3	9.8	10.9
OMQ-92				14.9	20.5	23.7	30.7	OMQ-92				10.2	11.2	11.8	13.1
OMQ-110				17.3	23.7	27.3	35.1	OMQ-110				12.7	14.1	14.8	16.4
OMTQ-60				9.4	13.1	15.1	19.6	OMTQ-60				7.0	7.5	7.8	8.4
OMTQ-76				11.1	15.1	17.3		OMTQ-76				9.3	10.1	10.6	
OMTQ-90				14.2	19.9	23.1	30.2	OMTQ-90				9.6	10.3	10.7	11.5
Low Temperature Models															
OLQ-18V		6.0	7.1	9.7	13.1	15.0		OLQ-18V		4.6	5.0	6.0	7.1	7.8	
OLQ-24V		7.2	8.7	12.3	16.4	18.6	23.3	OLQ-24V		5.6	6.0	6.8	7.9	8.5	10.1
OLQ-33V		9.8	11.9	16.8	22.8	26.1	33.7	OLQ-33V		7.4	7.9	8.8	10.0	10.7	12.2
OLQ-40V		11.8	14.9	21.4	28.4	32.0	39.3	OLQ-40V		8.7	9.8	12.0	14.0	15.1	17.4
OLQ-48V		14.7	17.6	24.0	30.9	34.3		OLQ-48V		11.1	12.2	14.7	18.1	20.2	
OLTQ-26V		8.2	9.9	14.3	19.8	23.1	31.1	OLTQ-26V		6.4	6.7	7.4	8.2	8.7	9.6
OLTQ-36V		12.1	14.4	20.0	27.1	31.4		OLTQ-36V		8.9	9.6	11.1	12.8	13.8	
Digital Medium Temperature Models															
OMQ-30D				4.6	6.2	7.0	8.8	OMQ-30D				3.2	3.7	3.9	4.5
OMQ-45D				6.9	9.4	10.8	13.7	OMQ-45D				4.4	5.2	5.6	6.4
OMTQ-60D				9.5	13.2	15.2	19.7	OMTQ-60D				6.5	7.2	7.5	8.3
OMTQ-90D				13.9	20.0	23.5	31.5	OMTQ-90D				9.6	10.4	10.9	12.1
Digital Low Temperature Models															
OLQ-18DV		6.1	7.3	10.2	13.9	16.1	21.3	OLQ-18DV		4.3	4.7	5.3	6.0	6.5	7.4
OLTQ-36DV		12.1	14.4	20.0	27.1	31.4		OLTQ-36DV		8.9	9.6	11.1	12.8	13.8	

Conditions: EN13215: Suction Gas Return 20°C, Subcooling 0K

Ambient Temperature: 32°C															
R407C	Cooling Capacity (kW)							R407C	Power Input (kW)						
	Evaporating Temperature (°C)								Evaporating Temperature (°C)						
	-45	-35	-30	-20	-10	-5	+5		-45	-35	-30	-20	-10	-5	+5
Medium Temperature Models															
OMQ-56				6.9*	10.4*	12.7	17.4	OMQ-56				5.3*	5.8*	6.1	6.6
OMQ-75				9.3*	13.7*	16.2*	22.2	OMQ-75				6.7*	7.7*	8.2*	9.4
OMQ-92				12.0*	17.8*	21.7	29.6	OMQ-92				8.4*	9.4*	10.0	11.1
OMQ-110				14.2*	21.1*	25.6	34.7	OMQ-110				10.6*	12.0*	12.8	14.4
OMTQ-60				7.2*	11.3*	13.9	19.3	OMTQ-60				5.6*	6.2*	6.6	7.4
OMTQ-76				8.1*	12.9*	15.7*	22.3	OMTQ-76				6.8*	7.8*	8.4*	9.8
OMTQ-90				10.6*	17.0*	21.0	29.3	OMTQ-90				7.8*	8.6*	9.1	10.1

Conditions: EN13215: Suction Gas Return 20°C, Subcooling 0K

* Conditions: EN13215: Suction Superheat 10K

Capacity Data

Ambient Temperature: 32°C															
R134a	Cooling Capacity (kW)							R134a	Power Input (kW)						
	Evaporating Temperature (°C)								Evaporating Temperature (°C)						
	-45	-35	-30	-20	-10	-5	+5		-45	-35	-30	-20	-10	-5	+5
Medium Temperature Models															
OMQ-56				4.6*	7.3*	9.1	13.0	OMQ-56				3.3*	3.6*	3.7	4.0
OMQ-75				6.4*	9.8*	12.3	17.2	OMQ-75				4.0*	4.6*	4.9	5.6
OMQ-92				8.1*	12.6*	15.7	22.2	OMQ-92				5.4*	5.9*	6.2	6.8
OMTQ-60				5.1*	8.3*	10.5	15.1	OMTQ-60				3.8*	4.0*	4.2	4.5
OMTQ-76				6.1*	10.0*	12.6	18.0	OMTQ-76				4.4*	4.9*	5.1	5.7
OMTQ-90				7.7*	12.3*	15.6	22.5	OMTQ-90				5.5*	5.7*	5.9	6.4
OMQ-110				9.9*	15.2*	19.0	26.6	OMQ-110				6.6*	7.3*	7.8	8.6
Digital Medium Temperature Models															
OMQ-30D					4.3	5.1	7.1	OMQ-30D					2.0	2.2	2.5
OMQ-45D					6.2	7.6	10.7	OMQ-45D					2.8	3.0	3.4
OMTQ-60D				5.3*	8.7	10.5	14.9	OMTQ-60D				3.5*	3.9	4.1	4.6
OMTQ-90D				8.3	12.8	15.6	22.4	OMTQ-90D				5.1	5.6	5.9	6.5

Conditions: EN13215: Suction Gas Return 20°C, Subcooling 0K

* Conditions: EN13215: Suction Superheat 10K

Preliminary Data

Ambient Temperature: 32°C															
R450A	Cooling Capacity (kW)							R450A	Power Input (kW)						
	Evaporating Temperature (°C)								Evaporating Temperature (°C)						
	-45	-35	-30	-20	-10	-5	+5		-45	-35	-30	-20	-10	-5	+5
Digital Medium Temperature Models															
OMQ-30D				2.3*	3.8	4.6	6.6	OMQ-30D				1.5*	1.7	1.8	2.0
OMQ-45D				3.6	5.7	6.9	10.0	OMQ-45D				2.1	2.4	2.5	2.9

Conditions: EN13215: Suction Gas Return 20°C, Subcooling 0K

* Conditions: EN13215: Suction Superheat 10K

Preliminary Data

Ambient Temperature: 32°C															
R513A	Cooling Capacity (kW)							R513A	Power Input (kW)						
	Evaporating Temperature (°C)								Evaporating Temperature (°C)						
	-45	-35	-30	-20	-10	-5	+5		-45	-35	-30	-20	-10	-5	+5
Digital Medium Temperature Models															
OMQ-30D				2.7*	4.4	5.3	7.4	OMQ-30D				1.8*	2.0	2.1	2.4
OMQ-45D				4.0*	6.6	8.0	11.2	OMQ-45D				2.5*	2.8	3.0	3.5

Conditions: EN13215: Suction Gas Return 20°C, Subcooling 0K

* Conditions: EN13215: Suction Superheat 10K

Preliminary Data

Copeland EazyCool™ ZX Outdoor Refrigeration Units With Scroll Compressors

Copeland™ compact outdoor refrigeration units are for medium-temperature and low-temperature applications.

With this new range of outdoor refrigeration units, Emerson Climate Technologies offers a solution for refrigeration applications with space and noise constraints which responds to the increasing demand for energy-efficient refrigeration solutions units.

Copeland EazyCool ZX outdoor refrigeration units feature the most complete and unique equipment. Their advanced electronic controller enables precise parameter control and displays the system status. Vapor injection and liquid injection technology significantly increase system efficiency and operation map. Electronic protection functions, oil separator and suction accumulator guarantee optimum system safety.

Lowest life cycle costs and comprehensive safety features make Copeland EazyCool ZX a cost efficient and reliable choice for:

- Convenience stores
- Cold rooms
- Fast food stores, bars and restaurants
- Beverage coolers



Copeland EazyCool ZX Outdoor Refrigeration Units with Scroll Compressors

Copeland EazyCool ZX Line-up

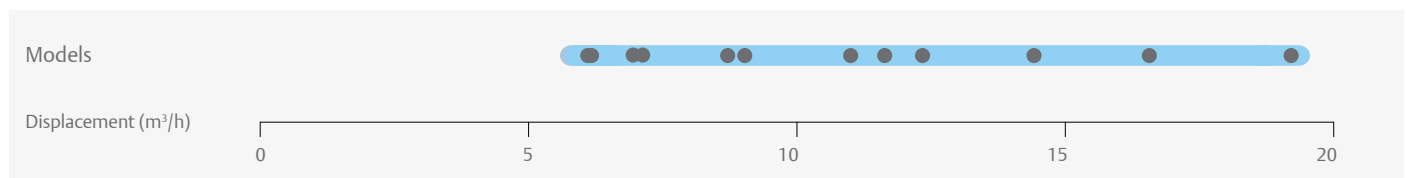

Copeland EazyCool ZX Digital Line-up

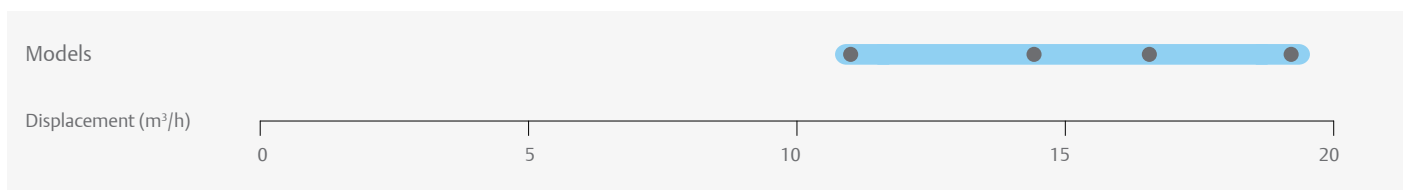

Features and Benefits

- Standard equipment: Copeland Scroll™ compressor, crankcase heater, electronic controller, fan(s) with speed control, liquid receiver, safety switches, filter drier and sight glass, oil separator and suction accumulator (LT models only)
- Copeland EazyCool ZX Digital models allow for 10% to 100% continuous capacity modulation
- Diagnostic capabilities protect the unit from over-current, phase loss and phase imbalance
- LED display shows real time system status
- Precise electronic suction pressure control
- Energy and operation cost saving due to excellent energy efficiency
- Noise attenuation due to low speed fan motors with sickle blades, fan speed control and sound jacket
- High capacity vapor injection technology for LT models
- Space saving due to compact dimensions
- Easy and quick installation
- Multiple refrigerant approvals incl. R407A/F, R448A/R449A, R404A, R134a, R450A and R513A

Maximum Allowable Pressures (PS)

- Low Side PS 22.5 bar (g)
- High Side PS 28.8 bar (g)

Technical Overview

Model	Displacement (m ³ /h)	Receiver Capacity (l)	Number of fans	Total Fan Motor Power (W)	Suction Line Diameter (inch)	Liquid Line Diameter (inch)	Width/Depth/Height (mm)	Net Weight (kg)	Motor Version/ Code		Maximum Operating Current (A)		Locked Rotor Current (A)		Sound Pressure @10m - dB(A)***
									1 Ph*	3 Ph**	1 Ph*	3 Ph**	1 Ph*	3 Ph**	
Medium Temperature Models															
ZXME020E	5.9	4.4	1	116	3/4	1/2	1029/424/840	76.0	PFJ	TFD	13	5	58	26	39.0
ZXME025E	6.8	4.4	1	116	3/4	1/2	1029/424/840	79.0	PFJ	TFD	12	5	61	38	40.0
ZXME030E	8.6	4.4	1	116	3/4	1/2	1029/424/840	79.0	PFJ	TFD	16	7	82	40	40.0
ZXME040E	11.7	4.4	1	116	7/8	1/2	1029/424/840	91.0	PFJ	TFD	24	10	114	49	40.0
ZXME040E	14.4	4.4	1	116	7/8	1/2	1029/424/840	91.0		TFD		10		49	40.0
ZXME050E	17.1	6.3	2	246	7/8	1/2	1029/424/1242	108.0		TFD		13		66	41.0
ZXME060E	18.8	6.3	2	246	7/8	1/2	1029/424/1242	112.0		TFD		13		74	41.0
ZXME075E	11.9	6.3	2	246	7/8	1/2	1029/424/1242	118.0		TFD		14		101	42.0
Digital Medium Temperature Models															
ZXDE-040E	11.4	6.3	2	246	7/8	1/2	1029/424/1242	104.0		TFD		8		48	40.0
ZXDE-050E	14.4	6.3	2	246	7/8	1/2	1029/424/1242	108.0		TFD		11		64	41.0
ZXDE-060E	17.1	6.3	2	246	7/8	1/2	1029/424/1242	112.0		TFD		11		74	41.0
ZXDE-075E	18.8	6.3	2	246	7/8	1/2	1029/424/1242	118.0		TFD		14		100	42.0
Low Temperature Models															
ZXLE020E	6.1	4.4	1	116	3/4	1/2	1029/424/840	79.0	PFJ	TFD	14	6	57	39	39.0
ZXLE025E	7.1	4.4	1	116	3/4	1/2	1029/424/840	79.0	PFJ	TFD	16	6	74	39	39.0
ZXLE030E	8.0	4.4	1	116	3/4	1/2	1029/424/840	81.0	PFJ	TFD	18	7	82	36	40.0
ZXLE040E	12.7	4.4	1	116	7/8	1/2	1029/424/840	93.0		TFD		9		52	40.0
ZXLE050E	14.4	6.3	2	246	7/8	1/2	1029/424/1242	106.0		TFD		12		52	41.0
ZXLE060E	17.1	6.3	2	246	7/8	1/2	1029/424/1242	116.0		TFD		14		74	41.0
ZXLE075E	18.8	6.3	2	246	7/8	1/2	1029/424/1242	121.0		TFD		15		101	41.0

* 1ph: 230V/ 50Hz

** 3 Ph: 380-420V/ 50Hz

*** @ 10m: sound pressure level at 10m distance from the compressor, free field condition

Capacity Data

Ambient Temperature: 32°C																
R407A	Cooling Capacity (kW)							R407A	Power Input (kW)							
	Evaporating Temperature (°C)								Evaporating Temperature (°C)							
	-45	-35	-30	-20	-10	-5	+5		-45	-35	-30	-20	-10	-5	+5	
Medium Temperature Models																
ZXME020E					3.5	4.1	5.6	ZXME020E						1.7	1.7	1.7
ZXME025E**					3.9	4.7	6.6	ZXME025E**						1.7	1.8	1.9
ZXME030E					4.9	5.9	8.3	ZXME030E						2.3	2.4	2.6
ZXME040E**					6.0	7.1	9.9	ZXME040E**						3.0	3.1	3.5
ZXME040E					6.3	7.5	10.3	ZXME040E						3.2	3.4	3.8
ZXME050E					8.7	10.4	14.4	ZXME050E						3.7	3.9	4.3
ZXME060E					9.8	11.8	16.4	ZXME060E						4.3	4.5	5.0
ZXME075E					11.3	13.6	18.9	ZXME075E						4.9	5.1	5.6
Low Temperature Models																
ZXLE020E		1.5	1.9	3.0	4.3	5.1	6.7	ZXLE020E		1.4	1.5	1.6	1.8	1.8	2.0	
ZXLE025E		1.8	2.2	3.4	5.0	5.9	7.9	ZXLE025E		1.6	1.7	1.8	2.0	2.0	2.3	
ZXLE030E		2.0	2.5	3.9	5.6	6.6	8.7	ZXLE030E		1.8	1.9	2.0	2.2	2.3	2.5	
ZXLE040E		3.1	3.9	5.9	8.3	9.6		ZXLE040E		2.7	2.9	3.4	4.0	4.4		
ZXLE050E		3.6	4.5	6.8	9.7	11.4	14.8	ZXLE050E		3.1	3.2	3.7	4.3	4.7	5.4	
ZXLE060E		4.2	5.3	7.9	11.3	13.1		ZXLE060E		3.7	3.9	4.5	5.3	5.8		
ZXLE075E		4.8	5.9	9.0	13.0	15.2	19.9	ZXLE075E		3.9	4.1	4.6	5.4	5.8	6.7	
Digital Medium Temperature Models																
ZXDE-040E				4.7	7.3	8.8	12.5	ZXDE-040E					2.7	2.8	2.9	3.1
ZXDE-050E				5.8	8.7	10.4	14.4	ZXDE-050E					3.5	3.7	3.9	4.3
ZXDE-060E				6.4	9.8	11.8	16.4	ZXDE-060E					4.0	4.3	4.5	5.0
ZXDE-075E				7.4	11.3	13.6	18.9	ZXDE-075E					4.5	4.9	5.1	5.6

Suction Gas Return 20°C / Subcooling 0K

** Single Phase Only

Preliminary Data

Capacity Data

Ambient Temperature: 32°C															
R407F	Cooling Capacity (kW)							R407F	Power Input (kW)						
	Evaporating Temperature (°C)								Evaporating Temperature (°C)						
	-45	-35	-30	-20	-10	-5	+5		-45	-35	-30	-20	-10	-5	+5
Medium Temperature Models															
ZXME020E					3.4	4.0	5.7	ZXME020E					1.6	1.6	1.7
ZXME025E**				3.3	5.0	6.0	8.4	ZXME025E**				2.1	2.3	2.5	2.7
ZXME030E					4.9	5.9	8.3	ZXME030E					2.3	2.4	2.6
ZXME040E**				4.0	6.0	7.1	9.9	ZXME040E**				2.8	3.0	3.1	3.5
ZXME040E					6.5*	8.0	10.9	ZXME040E					3.3*	3.5	4.0
ZXME050E				5.7*	8.6	10.4	14.4	ZXME050E				3.5*	3.7	3.9	4.3
ZXME060E				6.2*	9.7	11.8	16.4	ZXME060E				4.0*	4.3	4.5	5.0
ZXME075E				7.1*	11.2	13.6	18.9	ZXME075E				4.5*	4.9	5.1	5.6
Low Temperature Models															
ZXLE020E		1.6	2.0	3.1	4.5	5.3	7.0	ZXLE020E		1.5	1.6	1.7	1.9	1.9	2.2
ZXLE025E		1.8	2.3	3.6	5.3	6.2	8.2	ZXLE025E		1.7	1.8	1.9	2.1	2.2	2.4
ZXLE030E		2.1	2.6	4.0	5.9	6.9	9.1	ZXLE030E		1.9	2.0	2.1	2.3	2.4	2.7
ZXLE040E		3.3	4.1	6.1	8.6*	10.0*		ZXLE040E		2.9	3.1	3.6	4.3*	4.7*	
ZXLE050E		3.8	4.7	7.1	10.2	11.9	15.4	ZXLE050E		3.2	3.4	3.9	4.6	5.0	5.8
ZXLE060E		4.4	5.5	8.3	11.8	13.7		ZXLE060E		3.9	4.1	4.8	5.7	6.2	
ZXLE075E		5.0	6.2	9.4	13.6	15.9	20.8	ZXLE075E		4.1	4.3	4.9	5.7	6.2	7.2
Digital Medium Temperature Models															
ZXDE-040E				4.7	7.2	8.8	12.4	ZXDE-040E				2.8	2.9	3.0	3.2
ZXDE-050E				5.7	8.6	10.5	14.6	ZXDE-050E				3.6	3.9	4.1	4.5
ZXDE-060E				5.9	9.0	10.9	15.1	ZXDE-060E				3.9	4.2	4.4	4.8
ZXDE-075E				6.7	10.2	12.3	17.2	ZXDE-075E				4.3	4.6	4.8	5.2

Suction Gas Return 20°C / Subcooling 0K

*Suction Superheat 10K, Subcooling 0K

** Single Phase Only

Preliminary Data

Capacity Data

Ambient Temperature: 32°C															
R448A	Cooling Capacity (kW)							R448A	Power Input (kW)						
	Evaporating Temperature (°C)								Evaporating Temperature (°C)						
	-45	-35	-30	-20	-10	-5	+5		-45	-35	-30	-20	-10	-5	+5
Medium Temperature Models															
ZXME020E				2.2	3.4	4.1	5.8	ZXME020E				1.6	1.6	1.6	1.8
ZXME025E**				2.6	4.0	4.8	6.8	ZXME025E**				1.7	1.8	1.9	2.0
ZXME030E				3.4	5.0	6.1	8.4	ZXME030E				2.1	2.3	2.4	2.6
ZXME040E				4.3	6.6	7.8	10.7	ZXME040E				3.0	3.3	3.5	3.9
ZXME050E				5.8	8.8	10.5	14.6	ZXME050E				3.6	3.8	3.9	4.3
ZXME060E				6.6	10.1	12.0	16.7	ZXME060E				4.1	4.4	4.6	5.0
ZXME075E				7.6	11.6	13.9	19.2	ZXME075E				4.7	5.1	5.3	5.8
Low Temperature Models															
ZXLE020E		1.6	2.0	3.1	4.4	5.2	7.0	ZXLE020E		1.4	1.5	1.7	1.8	1.8	1.9
ZXLE025E		1.8	2.3	3.6	5.2	6.2	8.3	ZXLE025E		1.6	1.7	1.9	2.0	2.0	2.1
ZXLE030E		2.1	2.6	4.0	5.7	6.8	9.3	ZXLE030E		1.8	1.9	2.0	2.1	2.2	2.3
ZXLE040E		3.2	4.0	6.0	8.3	9.7		ZXLE040E		2.6	2.9	3.3	3.7	3.9	
ZXLE050E		4.0	5.0	7.3	10.4	12.1	16.3	ZXLE050E		3.1	3.4	3.9	4.3	4.5	4.9
ZXLE060E		4.7	5.8	8.5	12.0	14.0		ZXLE060E		3.7	4.1	4.7	5.3	5.6	
ZXLE075E		5.2	6.5	9.7	13.7	16.2	21.8	ZXLE075E		3.9	4.2	4.8	5.3	5.6	6.1
Digital Medium Temperature Models															
ZXDE-040E				4.8	7.2	8.7	12.3	ZXDE-040E				2.5	2.7	2.8	3.1
ZXDE-050E				5.8	8.7	10.4	14.4	ZXDE-050E				3.2	3.7	3.9	4.4
ZXDE-060E				6.8	10.1	12.0	16.6	ZXDE-060E				3.9	4.5	4.8	5.5
ZXDE-075E				7.7	11.4	13.6	18.8	ZXDE-075E				4.2	4.8	5.1	5.8

Suction Gas Return 20°C / Subcooling 0K

** Single Phase Only

Preliminary Data

Capacity Data

Ambient Temperature: 32°C															
R449A	Cooling Capacity (kW)							R449A	Power Input (kW)						
	Evaporating Temperature (°C)								Evaporating Temperature (°C)						
	-45	-35	-30	-20	-10	-5	+5		-45	-35	-30	-20	-10	-5	+5
Medium Temperature Models															
ZXME020E				2.2	3.4	4.1	5.8	ZXME020E				1.6	1.6	1.6	1.8
ZXME025E**				2.6	4.0	4.8	6.8	ZXME025E**				1.7	1.8	1.9	2.0
ZXME030E				3.4	5.0	6.1	8.4	ZXME030E				2.1	2.3	2.4	2.6
ZXME040E				4.3	6.6	7.8	10.7	ZXME040E				3.0	3.3	3.5	3.9
ZXME050E				5.8	8.8	10.5	14.6	ZXME050E				3.6	3.8	3.9	4.3
ZXME060E				6.6	10.1	12.0	16.7	ZXME060E				4.1	4.4	4.6	5.0
ZXME075E				7.6	11.6	13.9	19.2	ZXME075E				4.7	5.1	5.3	5.8
Low Temperature Models															
ZXLE020E		1.6	2.0	3.1	4.4	5.2	7.0	ZXLE020E		1.4	1.5	1.7	1.8	1.8	1.9
ZXLE025E		1.8	2.3	3.6	5.2	6.2	8.3	ZXLE025E		1.6	1.7	1.9	2.0	2.0	2.1
ZXLE030E		2.1	2.6	4.0	5.7	6.8	9.3	ZXLE030E		1.8	1.9	2.0	2.1	2.2	2.3
ZXLE040E		3.2	4.0	6.0	8.3	9.7		ZXLE040E		2.6	2.9	3.3	3.7	3.9	
ZXLE050E		4.0	5.0	7.3	10.4	12.1	16.3	ZXLE050E		3.1	3.4	3.9	4.3	4.5	4.9
ZXLE060E		4.7	5.8	8.5	12.0	14.0		ZXLE060E		3.7	4.1	4.7	5.3	5.6	
ZXLE075E		5.2	6.5	9.7	13.7	16.2	21.8	ZXLE075E		3.9	4.2	4.8	5.3	5.6	6.1
Digital Medium Temperature Models															
ZXDE-040E				4.8	7.2	8.7	12.3	ZXDE-040E				2.5	2.7	2.8	3.1
ZXDE-050E				5.8	8.7	10.4	14.4	ZXDE-050E				3.2	3.7	3.9	4.4
ZXDE-060E				6.8	10.1	12.0	16.6	ZXDE-060E				3.9	4.5	4.8	5.5
ZXDE-075E				7.7	11.4	13.6	18.8	ZXDE-075E				4.2	4.8	5.1	5.8

Suction Gas Return 20°C / Subcooling 0K

** Single Phase Only

Preliminary Data

Capacity Data

Ambient Temperature: 32°C															
R404A	Cooling Capacity (kW)							R404A	Power Input (kW)						
	Evaporating Temperature (°C)								Evaporating Temperature (°C)						
	-45	-35	-30	-20	-10	-5	+5		-45	-35	-30	-20	-10	-5	+5
Medium Temperature Models															
ZXME020E				2.4	3.6	4.2	5.7	ZXME020E				1.8	1.8	1.8	1.8
ZXME025E**				3.0	4.3	5.1	6.9	ZXME025E**				1.9	2.0	2.0	2.1
ZXME030E				3.7	5.2	6.2	8.2	ZXME030E				2.4	2.5	2.6	2.7
ZXME040E**				4.7	6.8	8.0	10.6	ZXME040E**				3.2	3.4	3.5	3.8
ZXME040E				4.9	7.0	8.2	10.8	ZXME040E				3.2	3.4	3.5	3.8
ZXME050E				6.4	9.1	10.7	14.4	ZXME050E				4.0	4.2	4.3	4.5
ZXME060E				7.3	10.4	12.2	16.2	ZXME060E				4.6	4.8	5.0	5.3
ZXME075E				8.4	11.9	13.9	18.5	ZXME075E				5.1	5.4	5.5	5.9
Low Temperature Models															
ZXLE020E		1.9	2.4	3.5	4.9	5.7		ZXLE020E		1.6	1.7	1.9	2.1	2.1	
ZXLE025E		2.2	2.8	4.1	5.8	6.7		ZXLE025E		1.9	2.0	2.2	2.4	2.5	
ZXLE030E		2.6	3.2	4.6	6.4	7.4		ZXLE030E		2.1	2.2	2.4	2.6	2.6	
ZXLE040E		4.0	4.9	7.0	9.6	11.0		ZXLE040E		3.0	3.2	3.6	4.1	4.4	
ZXLE050E		5.0	6.0	8.5	11.5	13.2		ZXLE050E		3.6	3.9	4.4	5.0	5.4	
ZXLE060E		5.8	7.0	9.8	13.2	15.0	18.9	ZXLE060E		4.4	4.7	5.5	6.3	6.7	7.7
ZXLE075E		6.5	7.9	11.2	15.3	17.6		ZXLE075E		4.6	4.9	5.5	6.2	6.6	
Digital Medium Temperature Models															
ZXDE-040E				5.3	7.6	8.9	12.2	ZXDE-040E				2.7	3.0	3.1	3.3
ZXDE-050E				6.4	9.0	10.6	14.1	ZXDE-050E				3.6	4.0	4.3	4.7
ZXDE-060E				7.4	10.5	12.2	16.1	ZXDE-060E				4.3	4.9	5.2	5.8
ZXDE-075E				8.4	11.9	13.8	18.3	ZXDE-075E				4.7	5.3	5.6	6.3

Suction Gas Return 20°C / Subcooling 0K

** Single Phase Only

Ambient Temperature: 32°C															
R134a	Cooling Capacity (kW)							R134a	Power Input (kW)						
	Evaporating Temperature (°C)								Evaporating Temperature (°C)						
	-45	-35	-30	-20	-10	-5	+5		-45	-35	-30	-20	-10	-5	+5
Medium Temperature Models															
ZXME020E				1.4	2.3	2.8	4.0	ZXME020E				1.0	1.0	1.0	1.1
ZXME025E**				1.5	2.6	3.2	4.7	ZXME025E**				1.2	1.3	1.3	1.4
ZXME030E				2.1	3.2	4.0	5.8	ZXME030E				1.3	1.4	1.4	1.5
ZXME040E**				2.6	4.3	5.3	7.8	ZXME040E**				2.0	2.1	2.2	2.4
ZXME040E				2.8	4.4	5.4	7.8	ZXME040E				1.7	1.8	1.9	2.0
ZXME050E				3.4	5.5	6.8	9.9	ZXME050E				2.1	2.3	2.4	2.5
ZXME060E				4.2	6.5	8.0	11.7	ZXME060E				2.5	2.6	2.7	3.0
ZXME075E				4.8	7.5	9.1	13.2	ZXME075E				3.1	3.2	3.3	3.6
Digital Medium Temperature Models															
ZXDE-040E					4.3	5.3	8.0	ZXDE-040E					1.8	1.9	1.9
ZXDE-050E					5.3	6.5	9.7	ZXDE-050E					2.3	2.4	2.5
ZXDE-060E					6.3	7.9	11.7	ZXDE-060E					2.7	2.8	3.0
ZXDE-075E					7.2	8.8	12.7	ZXDE-075E					3.0	3.0	3.3

Suction Gas Return 20°C / Subcooling 0K

** Single Phase Only

Preliminary Data

Capacity Data

Ambient Temperature: 32°C															
R450A	Cooling Capacity (kW)							R450A	Power Input (kW)						
	Evaporating Temperature (°C)								Evaporating Temperature (°C)						
	-45	-35	-30	-20	-10	-5	+5		-45	-35	-30	-20	-10	-5	+5
Medium Temperature Models															
ZXME020E				1.2	2.0	2.5	3.6	ZXME020E				0.9	0.9	0.9	0.9
ZXME025E**				1.4	2.3	2.8	4.2	ZXME025E**				1.0	1.0	1.0	1.1
ZXME030E				1.8	2.9	3.6	5.3	ZXME030E				1.2	1.2	1.2	1.3
ZXME040E				2.5	3.9	4.9	7.1	ZXME040E				1.6	1.6	1.6	1.7
ZXME050E				3.1	5.0	6.1	9.1	ZXME050E				2.0	2.1	2.1	2.2
ZXME060E				3.6	5.8	7.1	10.5	ZXME060E				2.3	2.4	2.4	2.5
ZXME075E				4.0	6.5	8.0	11.8	ZXME075E				2.6	2.7	2.7	2.9
Digital Medium Temperature Models															
ZXDE-040E				2.5	3.9	4.9	7.1	ZXDE-040E				1.6	1.6	1.6	1.7
ZXDE-050E				3.1	5.0	6.1	9.1	ZXDE-050E				2.0	2.1	2.1	2.2
ZXDE-060E				3.6	5.8	7.1	10.5	ZXDE-060E				2.3	2.4	2.4	2.5
ZXDE-075E				4.0	6.5	8.0	11.8	ZXDE-075E				2.6	2.7	2.7	2.9

Suction Gas Return 20°C / Subcooling 0K

** Single Phase Only

Preliminary Data

Ambient Temperature: 32°C															
R513A	Cooling Capacity (kW)							R513A	Power Input (kW)						
	Evaporating Temperature (°C)								Evaporating Temperature (°C)						
	-45	-35	-30	-20	-10	-5	+5		-45	-35	-30	-20	-10	-5	+5
Medium Temperature Models															
ZXME020E				1.5	2.3	2.9	4.2	ZXME020E				1.0	1.0	1.0	1.1
ZXME025E**				1.7	2.7	3.3	4.9	ZXME025E**				1.2	1.2	1.2	1.3
ZXME030E				2.2	3.4	4.2	6.0	ZXME030E				1.4	1.4	1.5	1.6
ZXME040E				3.0	4.6	5.7	8.2	ZXME040E				1.9	1.9	2.0	2.1
ZXME050E				3.8	5.9	7.2	10.5	ZXME050E				2.4	2.5	2.5	2.6
ZXME060E				4.4	6.8	8.4	12.1	ZXME060E				2.8	2.8	2.9	3.0
ZXME075E				4.9	7.7	9.4	13.5	ZXME075E				3.1	3.2	3.2	3.4
Digital Medium Temperature Models															
ZXDE-040E				3.0	4.6	5.7	8.2	ZXDE-040E				1.9	1.9	2.0	2.1
ZXDE-050E				3.8	5.9	7.2	10.5	ZXDE-050E				2.4	2.5	2.5	2.6
ZXDE-060E				4.4	6.8	8.4	12.1	ZXDE-060E				2.8	2.8	2.9	3.0
ZXDE-075E				4.9	7.7	9.4	13.5	ZXDE-075E				3.1	3.2	3.2	3.4

Suction Gas Return 20°C / Subcooling 0K

** Single Phase Only

Preliminary Data

Copeland™ Outdoor Refrigeration Units for R744-Transcritical Applications

With this range of outdoor refrigeration units, Emerson offers a solution which responds to the increasing demand for future proof refrigeration technology.

These models are designed for operation with the natural refrigerant CO₂ which has a very low global warming potential (GWP) of only 1.

The range features the latest technology like Stream series compressors which are characterized by their silent and reliable operation. The integrated frequency inverter controls the compressor speed exactly to the capacity demand of the application. EC-fans remove the heat from the gas cooler in the most efficient and silent way.

The state of the art electronic controller allows for precise adjustment and control of all relevant parameters and comprises numerous electronic protection functions for highly reliable operation.

The refrigeration units are future-proof choice for various target applications:

- Convenience stores
- Forecourt sites
- Cold rooms
- Fast food stores, bars and restaurants



Copeland™ Outdoor Refrigeration Unit for R744-Transcritical Applications

Refrigeration Unit Line-up



Technical Overview

Model	Displacement @ 50 Hz [m ³ /h]	Cooling Capacity @ 50 Hz [kW]	Receiver Capacity (l)	Suction Tube Diameter inch	Discharge Tube Diameter inch	Dimensions W / D / H (mm)	Design Pressure High/Med/Low (bar)	Net Weight [kg]	Power Supply	Nominal Current (A)	Sound Pressure 10 m dB (A)
OME-4MTL-05X	4.6	8.72	20	3/4	1/2	1574/900/1120	120/90/90	440	3/N/PE~50Hz 400/230V TN-S	19	42 - 44
OME-4MTL-07X	6.2	11.81	20	3/4	5/8	1574/900/1120	120/90/90	440	3/N/PE~50Hz 400/230V TN-S	22	42 - 44
OME-4MTL-09X	7.4	14.65	25	7/8	5/8	1574/900/1120	120/90/90	460	3/N/PE~50Hz 400/230V TN-S	27	42 - 44

Features and Benefits

- Future-proof solution with natural GWP 1 refrigerant, not impacted by F-Gas legislation
- Low carbon footprint
- Silent operation due to special attenuation on panels and sound optimized EC fans
- High energy efficiency through inverter controlled compressor and EC fans
- Space saving design
- Time saving commissioning by pre-set parameters
- High reliability with electronic protection against incorrect voltage, phase, current and discharge temperature
- State of the art controller for precise system control
- Modbus communication and monitoring functionality
- LCD Display to show the operation status
- OilWatch maintains correct system oil level
- Controller prepared for heat recovery
- Easy access for time saving service
- Built and tested in advanced industrial processes
- Individual compressor power consumption monitoring

Design Pressure:

- 90 bar in receiver and liquid line
- 120 bar on high-pressure side



Copeland Scroll™ Indoor Refrigeration Units for Refrigeration

Copeland™ air-cooled refrigeration units for medium temperature and low temperature applications.

Copeland Scroll refrigeration units are equipped with the latest refrigeration scroll compressors and build the widest range of its kind. The modular line concept offers base units which can be adapted to the target application by various options including weather housings and fan speed controls.

Copeland Scroll refrigeration units are available with normal or high capacity condensers to ensure optimum performance even under extreme conditions. They are equipped with dedicated medium or low temperature compressors which makes them suitable for all general refrigeration applications, such as:

- Mini markets and supermarkets
- Bars, restaurants and kitchens
- Beer cellars and beverage coolers
- Cold rooms
- Milk cooling tank



Copeland Scroll
Indoor Refrigeration Unit

Copeland Scroll Refrigeration Units Line-up

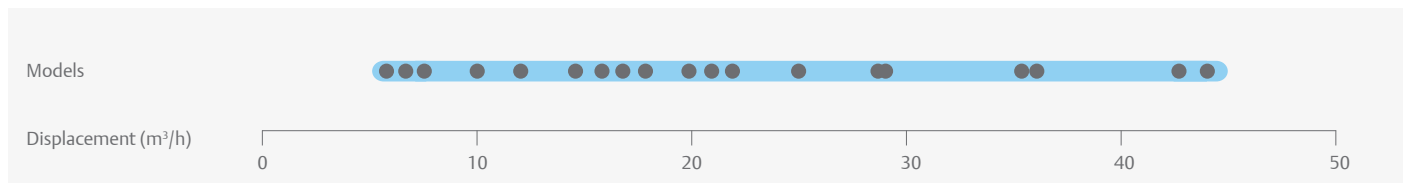

Copeland Scroll Digital Refrigeration Units Line-up

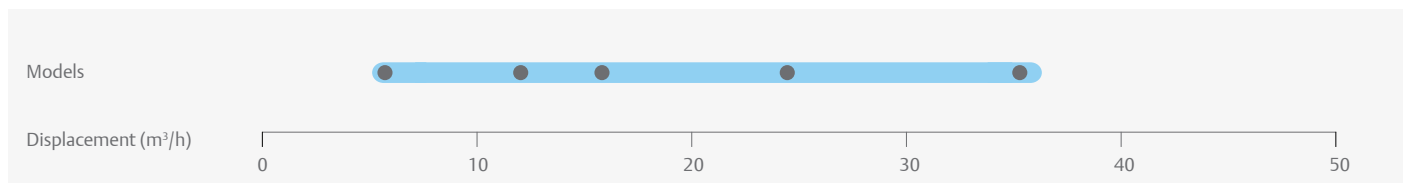

Features and Benefits

- Standard equipment: base plate, scroll compressor, crank case heater, condenser with 1 ph fan(s), HP and LP switch, liquid receiver with rotalock-valve, suction- and discharge shut-off valves
- Suitable for multiple refrigerants: R407A/F, R448A/R449A, R404A, R134a, R450A and R513A
- Wide range of quality accessories
- Excellent efficiency and reliability

Maximum Allowable Pressures (PS)

- Low Side PS 22.5 bar (g)
- High Side PS = 28 bar (g)

Technical Overview

Model	Displacement (m ³ /h)	Receiver Capacity (l)	Number of fans	Total Fan Motor Power (W)	Suction Line Diameter (inch)	Liquid Line Diameter (inch)	Width/Depth/Height (mm)	Net Weight (kg)	Motor Version/Code		Maximum Operating Current (A)		Locked Rotor Current (A)		Sound Pressure @10m - dB(A)***
									1 Ph*	3 Ph**	1 Ph*	3 Ph**	1 Ph*	3 Ph**	
Medium Temperature Models															
MC-D8-ZB15KE	5.9	3.9	1	110	3/4	1/2	560/570/446	48.0	PFJ	TFD	13	5	58	26	45.8
MC-H8-ZB15KE	5.9	7.9	1	235	3/4	1/2	735/680/533	57.0	PFJ	TFD	13	5	58	26	48.6
MC-D8-ZB19KE	6.8	3.9	1	110	3/4	1/2	560/570/446	49.0	PFJ	TFD	13	7	61	32	45.9
MC-K9-ZB19KE	6.8	7.9	2	220	3/4	1/2	950/640/454	66.5	PFJ	TFD	13	7	61	32	47.5
MC-H8-ZB19KE	6.8	7.9	1	235	3/4	1/2	735/680/533	61.0	PFJ	TFD	13	7	61	32	48.7
MC-D8-ZB21KE	8.6	3.9	1	110	7/8	1/2	560/570/446	50.0	PFJ	TFD	16	7	82	40	46.4
MC-H8-ZB21KE	8.6	7.9	1	235	7/8	1/2	735/680/533	61.0	PFJ	TFD	16	7	82	40	48.9
MC-K9-ZB21KE	8.6	7.9	2	220	7/8	1/2	950/640/454	67.5	PFJ	TFD	16	7	82	40	47.8
MC-K9-ZB26KE	10.0	7.9	2	220	7/8	1/2	950/640/454	68.0	PFJ	TFD	18	9	97	46	47.8
MC-H8-ZB26KE	10.0	7.9	1	235	7/8	1/2	735/680/533	62.0	PFJ	TFD	18	9	97	46	48.9
MC-H8-ZB30KE	11.7	7.9	1	235	7/8	1/2	735/680/533	74.0	PFJ	TFD	26	10	142	49	49.1
MC-M8-ZB30KE	11.7	7.9	1	235	7/8	1/2	735/730/708	86.5	PFJ	TFD	26	10	142	49	48.6
MC-P8-ZB30KE	11.7	7.9	2	220	7/8	1/2	950/640/633	86.5		TFD		10		49	48.5
MC-H8-ZB38KE	14.4	7.9	1	235	7/8	1/2	735/680/533	77.0	PFJ	TFD	32	13	142	66	49.2
MC-M8-ZB38KE	14.4	7.9	1	235	7/8	1/2	735/730/708	89.0	PFJ	TFD	32	13	142	66	48.8
MC-P8-ZB38KE	14.4	7.9	2	220	7/8	1/2	950/640/633	89.0	PFJ	TFD	32	13	142	66	48.7
MC-M8-ZB42KE	16.2	7.9	1	235	7/8	1/2	735/730/708	91.0	PFJ		36		150		49.4
MC-R7-ZB42KE	16.2	7.9	2	470	7/8	1/2	1130/680/633	101.0	PFJ		36		150		52.7
MC-M8-ZB45KE	17.1	7.9	1	235	7/8	1/2	735/730/708	91.0		TFD		13		74	49.4
MC-M9-ZB45KE	17.1	7.9	1	400	7/8	1/2	735/730/708	95.5		TFD		13		74	49.4
MC-R7-ZB45KE	17.1	7.9	2	470	7/8	1/2	1130/680/633	101.0		TFD		13		74	49.5
MC-R7-ZB50KE	19.8	7.9	2	470	1 3/8	1/2	1130/820/621	110.0		TFD		15		100	49.3
MC-S9-ZB50KE	22.1	11.7	2	470	1 3/8	5/8	1130/820/703	113.0		TFD		15		100	49.7
MC-R7-ZB58KE	22.1	7.9	2	470	1 3/8	1/2	1130/820/621	110.0		TFD		16		95	
MC-S9-ZB58KE	22.1	11.7	2	470	1 3/8	5/8	1130/820/703	113.0		TFD		16		95	
MC-S9-ZB66KE	24.9	11.7	2	470	1 3/8	5/8	1130/820/707	116.0		TFD		18		111	50.3
MC-V9-ZB66KE	24.9	15.8	2	470	1 3/8	3/4	1330/820/821	150.0		TFD		18		111	50.2
MC-V9-ZB76KE	29.1	15.8	2	470	1 3/8	3/4	1330/820/835	151.0		TFD		20		118	50.2
MC-V6-ZB76KE	29.1	15.8	2	800	1 3/8	3/4	1330/820/835	168.0		TFD		20		118	54.7
MC-V9-ZB95KE	36.4	15.8	2	470	1 3/8	3/4	1330/820/835	155.0		TFD		28		140	50.7
MC-V6-ZB95KE	36.4	15.8	2	800	1 3/8	3/4	1330/820/835	172.0		TFD		28		140	54.7
MC-V6-ZB114KE	43.3	15.8	2	800	1 3/8	3/4	1330/820/835	174.0		TFD		33		174	54.7
MC-W9-ZB114KE	43.3	15.8	2	800	1 3/8	3/4	1640/820/864	174.0		TFD		33		174	54.7
Digital Medium Temperature Models															
MC-M8-ZBD30	11.7	11.7	1	235	7/8	5/8	735/730/708	86.5		TFD		8		52	48.6
MC-M9-ZBD45	17.1	11.7	1	400	7/8	5/8	735/730/708	95.5		TFD		12		74	49.4
MC-V6-ZBDT60	23.4	18.9	2	800	1 3/8	3/4	1330/820/835	207.0		TFD		8+10			57.4
MC-V6-ZBDT90	34.1	18.9	2	800	1 3/8	3/4	1330/820/835	218.0		TFD		12+13			57.4
MC-S9-ZF48KE	11.7	11.7	2	470	1 3/8	5/8	1130/820/708	189.0		TWD		29		198	54.7

* 1ph: 230V/ 50Hz

** 3 Ph: 380-420V/ 50Hz

*** @ 10m: sound pressure level at 10m distance from the compressor, free field condition

Technical Overview

Models	Displacement (m ³ /h)	Receiver Capacity (l)	Number of Fans	Total Fan Motor Power (W)	Suction Line Diameter (inch)	Liquid Line Diameter (inch)	Width/Depth/Height (mm)	Net Weight (kg)	Motor Version/Code		Maximum Operating Current (A)		Locked Rotor Current (A)		Sound Pressure @10m - dB(A)***	
									1 Ph*	3 Ph**	1 Ph*	3 Ph**	1 Ph*	3 Ph**		
Low Temperature Models																
MC-B8-ZF06KE	3.3	3.3	1	85	7/8	1/2	560/570/396	64.0		TFD		5		26	46.7	
MC-D8-ZF09KE	3.9	3.9	1	110	7/8	1/2	560/570/446	64.0		TFD		6		40	46.7	
MC-H8-ZF09KE	7.9	7.9	1	235	7/8	1/2	735/680/533	66.0		TFD		6		40	49.1	
MC-H8-ZF11KE	7.9	7.9	1	235	7/8	1/2	735/680/533	67.0		TFD		7		46	49.4	
MC-H8-ZF13KE	7.9	7.9	1	235	7/8	1/2	735/680/533	77.0		TFD		8		52	49.5	
MC-M8-ZF13KE	7.9	7.9	1	235	7/8	1/2	735/730/708	85.0		TFD		8		52	49.0	
MC-M9-ZF13KE	7.9	7.9	1	400	7/8	1/2	735/730/708	95.5		TFD		8		52		
MC-H8-ZF15KE	7.9	7.9	1	235	7/8	1/2	735/680/533	83.0		TFD		10		64	50.0	
MC-M8-ZF15KE	7.9	7.9	1	235	7/8	1/2	735/730/708	86.0		TFD		10		64	49.6	
MC-R7-ZF15KE	7.9	7.9	2	470	1 3/8	1/2	1130/680/708	105.0		TFD		10		64	52.0	
MC-M8-ZF18KE	7.9	7.9	1	235	7/8	1/2	735/730/708	88.0		TFD		13		74	49.9	
MC-M9-ZF18KE	7.9	7.9	1	400	7/8	1/2	735/730/708	95.5		TFD		13		74	50.0	
MC-S9-ZF18KE	7.9	7.9	2	470	1 3/8	1/2	1130/680/708	168.0		TFD		13		74		
MC-S9-ZF25K5	11.7	11.7	2	470	1 1/8	5/8	1130/680/703	117.0		TFD		16		102	54.7	
MC-S9-ZF34K5	11.7	11.7	2	470	1 1/8	5/8	1130/680/703	141.0		TFD		25		100	54.7	
MC-V6-ZF41K5	11.7	11.7	2	800	1 3/8	5/8	1330/820/830	168.0		TFD		29		118	57.4	
MC-V6-ZF49K5	11.7	11.7	2	800	1 3/8	3/4	1330/820/830	185.0		TFD		30		139	57.4	

* 1ph: 230V/ 50Hz

** 3 Ph: 380-420V/ 50Hz

*** @ 10m: sound pressure level at 10m distance from the compressor, free field condition

Capacity Data

Ambient Temperature: 32°C															
R407A	Cooling Capacity (kW)							R407A	Power Input (kW)						
	Evaporating Temperature (°C)								Evaporating Temperature (°C)						
	-45	-35	-30	-20	-10	-5	+5		-45	-35	-30	-20	-10	-5	+5
Medium Temperature Models															
MC-H8-ZB15KE					3.5	4.2	5.9	MC-H8-ZB15KE					1.7	1.8	1.9
MC-D8-ZB15KE					3.2	3.8	5.3	MC-D8-ZB15KE					1.8	1.9	2.1
MC-D8-ZB19KE					3.7*	4.5	6.1	MC-D8-ZB19KE					2.2*	2.3	2.5
MC-K9-ZB19KE					4.1	4.9	6.8	MC-K9-ZB19KE					2.1	2.1	2.3
MC-H8-ZB19KE					4.1	4.9	6.9	MC-H8-ZB19KE					2.1	2.2	2.3
MC-K9-ZB21KE					4.8	5.8	8.0	MC-K9-ZB21KE					2.5	2.6	2.8
MC-H8-ZB21KE					4.8	5.8	8.0	MC-H8-ZB21KE					2.5	2.6	2.8
MC-D8-ZB21KE					4.2*	5.1		MC-D8-ZB21KE					2.7*	3.0	
MC-K9-ZB26KE					5.4	6.4	8.8	MC-K9-ZB26KE					2.9	3.0	3.4
MC-H8-ZB26KE					5.4	6.4	8.9	MC-H8-ZB26KE					2.9	3.0	3.4
MC-M8-ZB30KE					6.4	7.8	10.8	MC-M8-ZB30KE					3.3	3.4	3.7
MC-P8-ZB30KE					6.5	7.8	10.9	MC-P8-ZB30KE					3.2	3.4	3.7
MC-H8-ZB30KE					5.9*	7.3		MC-H8-ZB30KE					3.5*	3.7	
MC-H8-ZB38KE					7.2*	8.6*		MC-H8-ZB38KE					4.5*	4.9*	
MC-P8-ZB38KE					7.8*	9.6	13.0	MC-P8-ZB38KE					4.1*	4.4	5.0
MC-M8-ZB38KE					7.7*	9.5		MC-M8-ZB38KE					4.2*	4.5	
MC-R7-ZB42KE**				6.0*	9.3	11.1	15.3	MC-R7-ZB42KE**				4.4*	4.8	5.0	5.3
MC-M8-ZB42KE**				5.6*	8.2*	10.0	13.4	MC-M8-ZB42KE**				4.6*	5.1*	5.5	6.0
MC-M8-ZB45KE					8.5*	10.3		MC-M8-ZB45KE					5.2*	5.6	
MC-R7-ZB45KE					9.6	11.5	15.7	MC-R7-ZB45KE					4.9	5.1	5.5
MC-M9-ZB45KE					9.3	11.0	14.9	MC-M9-ZB45KE					5.1	5.3	5.8
MC-R7-ZB50KE					11.0	13.2	18.0	MC-R7-ZB50KE					6.0	6.3	6.9
MC-S9-ZB50KE					11.4	13.7	19.0	MC-S9-ZB50KE					5.7	5.9	6.4
MC-R7-ZB58KE					11.1*	13.8		MC-R7-ZB58KE					6.6*	7.1	
MC-S9-ZB58KE					11.9	14.5	20.4	MC-S9-ZB58KE					6.3	6.7	7.4
MC-V9-ZB66KE					13.8	16.7	23.2	MC-V9-ZB66KE					6.9	7.3	8.1
MC-S9-ZB66KE					13.2	15.9	21.9	MC-S9-ZB66KE					7.3	7.7	8.7
MC-V9-ZB76KE					15.8	19.0	26.3	MC-V9-ZB76KE					8.2	8.7	9.8
MC-V6-ZB76KE					16.7	20.2	28.4	MC-V6-ZB76KE					8.0	8.4	9.2
MC-V6-ZB95KE					19.5	23.5	32.6	MC-V6-ZB95KE					10.7	11.3	12.6
MC-V9-ZB95KE					17.4*	21.5		MC-V9-ZB95KE					11.3*	12.1	
MC-V6-ZB114KE					21.4*	26.8		MC-V6-ZB114KE					13.0*	13.9	
MC-W9-ZB114KE					22.5	27.4	38.4	MC-W9-ZB114KE					12.9	13.6	15.4

Suction Gas Return 20°C / Subcooling 0K

*Suction Superheat 10K, Subcooling 0K

** Single Phase Only

Preliminary Data

Capacity Data

Ambient Temperature: 32°C															
R407A	Cooling Capacity (kW)							R407A	Power Input (kW)						
	Evaporating Temperature (°C)								Evaporating Temperature (°C)						
	-45	-35	-30	-20	-10	-5	+5		-45	-35	-30	-20	-10	-5	+5
Low Temperature Models															
MC-H8-ZF09KE		1.7	2.1	3.2	4.7	5.5	7.6	MC-H8-ZF09KE		1.7	1.7	1.8	2.1	2.3	2.7
MC-D8-ZF09KE		1.6	2.0	3.0	4.3	5.0	6.6*	MC-D8-ZF09KE		1.7	1.7	1.9	2.1	2.3	2.8*
MC-M9-ZF13KE		2.3	2.9	4.5	6.7	8.0	11.1	MC-M9-ZF13KE		2.5	2.6	2.8	3.2	3.4	4.1
MC-H8-ZF13KE		2.3	2.8	4.3	6.3	7.4	10.0	MC-H8-ZF13KE		2.5	2.6	2.9	3.4	3.7	4.6
MC-M8-ZF13KE		2.3	2.9	4.4	6.5	7.7	10.6	MC-M8-ZF13KE		2.4	2.5	2.8	3.2	3.4	4.2
MC-M8-ZF15KE		2.8	3.5	5.3	7.6	9.0	12.2	MC-M8-ZF15KE		2.9	3.1	3.6	4.2	4.7	5.8
MC-R7-ZF15KE		2.9	3.6	5.6	8.2	9.7	13.5	MC-R7-ZF15KE		3.0	3.1	3.5	4.0	4.4	5.3
MC-H8-ZF15KE		2.7	3.4	5.1	7.2	8.5		MC-H8-ZF15KE		3.0	3.3	3.8	4.6	5.1	
MC-S9-ZF18KE		3.5	4.4	6.7	9.9	11.8	16.3	MC-S9-ZF18KE		3.5	3.7	4.1	4.6	4.9	5.8
MC-M8-ZF18KE		3.3	4.2	6.2	8.9	10.4	13.7*	MC-M8-ZF18KE		3.6	3.8	4.4	5.1	5.6	6.8*
MC-M9-ZF18KE		3.4	4.3	6.5	9.3	11.1	14.9	MC-M9-ZF18KE		3.6	3.8	4.3	4.9	5.3	6.4
MC-S9-ZF25K5		4.4	5.5	8.5	12.4	14.8		MC-S9-ZF25K5		4.3	4.6	5.3	6.2	6.7	
MC-S9-ZF34K5		5.9	7.5	11.4	16.4	19.4		MC-S9-ZF34K5		5.6	6.2	7.4	9.0	9.9	
MC-V6-ZF41K5		7.4	9.4	14.2	20.6	24.4		MC-V6-ZF41K5		6.8	7.4	8.7	10.2	11.1	
MC-V6-ZF49K5		8.7	11.1	16.9	24.5	29.1		MC-V6-ZF49K5		8.3	9.1	10.8	12.8	13.9	
Digital Medium Temperature Models															
MC-M8-ZBD30					6.8	8.1	11.1	MC-M8-ZBD30					3.4	3.6	4.0
MC-M9-ZBD45					9.2	11.0	15.0	MC-M9-ZBD45					4.9	5.2	5.8
MC-V6-ZBDT60				9.4	14.4	17.4	24.3	MC-V6-ZBDT60				6.0	6.4	6.7	7.3
MC-V6-ZBDT90				12.7	19.1	22.8	31.4	MC-V6-ZBDT90				8.8	9.5	9.9	10.9

Suction Gas Return 20°C / Subcooling 0K

*Suction Superheat 10K, Subcooling 0K

** Single Phase Only

Preliminary Data

Capacity Data

Ambient Temperature: 32°C															
R407F	Cooling Capacity (kW)							R407F	Power Input (kW)						
	Evaporating Temperature (°C)								Evaporating Temperature (°C)						
	-45	-35	-30	-20	-10	-5	+5		-45	-35	-30	-20	-10	-5	+5
Medium Temperature Models															
MC-H8-ZB15KE					3.4	4.1	5.7	MC-H8-ZB15KE					1.8	1.9	1.9
MC-D8-ZB15KE					3.0	3.7	5.0	MC-D8-ZB15KE					2.0	2.0	2.2
MC-H8-ZB19KE					4.0	4.8	6.7	MC-H8-ZB19KE					2.2	2.3	2.5
MC-K9-ZB19KE					4.0	4.8	6.7	MC-K9-ZB19KE					2.2	2.3	2.5
MC-D8-ZB19KE					3.5*	4.3	5.9	MC-D8-ZB19KE					2.4*	2.5	2.8
MC-K9-ZB21KE					4.7	5.6	7.7	MC-K9-ZB21KE					2.7	2.9	3.1
MC-H8-ZB21KE					3.9*	4.7*		MC-H8-ZB21KE					3.0*	3.2*	
MC-H8-ZB26KE					5.1*	6.3	8.6	MC-H8-ZB26KE					3.3*	3.5	3.9
MC-K9-ZB26KE					5.1*	6.3	8.6	MC-K9-ZB26KE					3.3*	3.5	3.9
MC-M8-ZB30KE				4.1*	6.6	8.0	11.2	MC-M8-ZB30KE				3.3*	3.5	3.7	4.1
MC-P8-ZB30KE				4.1*	6.6	8.0	11.3	MC-P8-ZB30KE				3.2*	3.5	3.6	4.0
MC-H8-ZB30KE					6.1*	7.5		MC-H8-ZB30KE					3.8*	4.0	
MC-M8-ZB38KE					7.6*	9.3		MC-M8-ZB38KE					4.7*	4.9	
MC-P8-ZB38KE					7.7*	9.4		MC-P8-ZB38KE					4.6*	4.9	
MC-H8-ZB38KE					7.0*	8.4*		MC-H8-ZB38KE					5.0*	5.3*	
MC-R7-ZB45KE				5.9*	9.7	11.8	16.4	MC-R7-ZB45KE				4.7*	5.2	5.5	6.0
MC-M9-ZB45KE					9.1*	11.2	15.5	MC-M9-ZB45KE					5.4*	5.7	6.4
MC-M8-ZB45KE					8.4*	10.2*		MC-M8-ZB45KE					5.6*	6.0*	
MC-R7-ZB58KE					11.7*	14.6		MC-R7-ZB58KE					7.1*	7.6	
MC-S9-ZB58KE				7.1*	12.4*	15.4	21.5	MC-S9-ZB58KE				6.0*	6.7*	7.2	8.1
MC-V9-ZB66KE				8.7*	14.6	17.7	24.6	MC-V9-ZB66KE				6.6*	7.4	7.8	8.7
MC-S9-ZB66KE					13.6*	16.8		MC-S9-ZB66KE					7.7*	8.3	
MC-V9-ZB76KE				9.8*	16.3*	20.1	27.8	MC-V9-ZB76KE				7.6*	8.7*	9.4	10.7
MC-V6-ZB76KE				10.6*	17.8	21.6	30.2	MC-V6-ZB76KE				7.6*	8.5	8.9	9.9
MC-W9-ZB114KE				13.3*	23.2*	29.0		MC-W9-ZB114KE				12.1*	13.7*	14.7	
MC-V6-ZB114KE					22.6*	28.2		MC-V6-ZB114KE					14.0*	15.1	
Low Temperature Models															
MC-B8-ZF06KE		1.2	1.4	2.1				MC-B8-ZF06KE		1.5	1.6	1.8			
MC-H8-ZF09KE		1.7	2.2	3.3	4.9	5.8	7.9	MC-H8-ZF09KE		1.8	1.8	1.9	2.2	2.4	2.8
MC-D8-ZF09KE		1.7	2.1	3.1	4.4	5.2		MC-D8-ZF09KE		1.8	1.8	2.0	2.3	2.5	
MC-H8-ZF11KE		2.2	2.7	4.1	5.9	6.9	9.3	MC-H8-ZF11KE		2.1	2.2	2.4	2.7	3.0	3.5
MC-M9-ZF13KE		2.4	3.1	4.7	7.0	8.3	11.6	MC-M9-ZF13KE		2.6	2.7	3.0	3.3	3.6	4.3
MC-M8-ZF13KE		2.4	3.0	4.6	6.8	8.1	11.0	MC-M8-ZF13KE		2.5	2.6	2.9	3.4	3.7	4.5
MC-H8-ZF13KE		2.4	3.0	4.5	6.5	7.7		MC-H8-ZF13KE		2.6	2.8	3.1	3.6	4.0	
MC-H8-ZF15KE		2.8	3.6	5.3	7.5			MC-H8-ZF15KE		3.2	3.5	4.1	5.0		
MC-R7-ZF15KE		3.0	3.8	5.8	8.5	10.2	14.0	MC-R7-ZF15KE		3.1	3.3	3.7	4.2	4.6	5.6
MC-M8-ZF15KE		2.9	3.7	5.5	8.0	9.4		MC-M8-ZF15KE		3.0	3.3	3.8	4.5	5.0	
MC-M8-ZF18KE		3.5	4.3	6.5	9.2	10.8		MC-M8-ZF18KE		3.8	4.1	4.7	5.5	6.0	
MC-M9-ZF18KE		3.5	4.5	6.8	9.7	11.5		MC-M9-ZF18KE		3.8	4.0	4.6	5.2	5.7	
MC-S9-ZF18KE		3.6	4.6	7.1	10.4	12.3	17.0	MC-S9-ZF18KE		3.7	3.9	4.3	4.9	5.2	6.1
Digital Medium Temperature Models															
MC-M8-ZBD30				4.6*	6.8	8.1	10.9	MC-M8-ZBD30				2.8*	3.3	3.6	4.1
MC-M9-ZBD45					9.4*	11.6	15.5	MC-M9-ZBD45					5.1*	5.5	6.6
MC-V6-ZBDT60				9.1*	14.3	17.2	24.0	MC-V6-ZBDT60				6.1*	6.7	6.9	7.6
MC-V6-ZBDT90				12.1*	19.7	23.7	32.6	MC-V6-ZBDT90				8.7*	10.1	10.7	12.2

Suction Gas Return 20°C / Subcooling 0K

*Suction Superheat 10K, Subcooling 0K

Preliminary Data

Capacity Data

Ambient Temperature: 32°C															
R448A	Cooling Capacity (kW)							R448A	Power Input (kW)						
	Evaporating Temperature (°C)								Evaporating Temperature (°C)						
	-45	-35	-30	-20	-10	-5	+5		-45	-35	-30	-20	-10	-5	+5
Medium Temperature Models															
MC-D8-ZB15KE				2.1	3.2	3.8	5.3	MC-D8-ZB15KE				1.7	1.8	1.8	2.0
MC-H8-ZB15KE				2.2	3.5	4.2	5.9	MC-H8-ZB15KE				1.7	1.7	1.7	1.8
MC-D8-ZB19KE				2.3*	3.7	4.4	6.0	MC-D8-ZB19KE				2.0*	2.1	2.2	2.5
MC-H8-ZB19KE				2.6	4.0	4.8	6.6	MC-H8-ZB19KE				1.9	2.0	2.1	2.3
MC-K9-ZB19KE				2.6	3.9	4.7	6.6	MC-K9-ZB19KE				1.9	2.0	2.0	2.3
MC-D8-ZB21KE				2.9*	4.5	5.3	7.0	MC-D8-ZB21KE				2.4*	2.8	3.0	3.4
MC-H8-ZB21KE				3.3	4.9	5.9	8.1	MC-H8-ZB21KE				2.3	2.5	2.6	2.8
MC-K9-ZB21KE				3.3	4.9	5.9	8.1	MC-K9-ZB21KE				2.3	2.5	2.6	2.9
MC-H8-ZB26KE				3.8	5.6	6.7	9.2	MC-H8-ZB26KE				2.8	3.0	3.1	3.5
MC-K9-ZB26KE				3.7	5.6	6.6	9.1	MC-K9-ZB26KE				2.8	3.0	3.2	3.5
MC-H8-ZB30KE				4.0*	6.4	7.5	10.3	MC-H8-ZB30KE				3.2*	3.6	3.8	4.2
MC-P8-ZB30KE				4.4	6.7	8.0	11.0	MC-P8-ZB30KE				3.1	3.3	3.4	3.8
MC-M8-ZB30KE				4.4	6.7	8.0	10.9	MC-M8-ZB30KE				3.1	3.3	3.5	3.9
MC-H9-ZB38KE				4.7*	7.5	8.8		MC-H9-ZB38KE				4.3*	4.8	5.1	
MC-P8-ZB38KE				5.1*	8.0	9.5	13.0	MC-P8-ZB38KE				3.9*	4.3	4.5	5.1
MC-M8-ZB38KE				5.0*	8.0	9.4	12.8	MC-M8-ZB38KE				4.0*	4.4	4.6	5.2
MC-M8-ZB42KE**				5.5*	8.7	10.3	13.9	MC-M8-ZB42KE**				4.6*	5.2	5.5	6.2
MC-R7-ZB42KE**				6.3	9.5	11.4	15.7	MC-R7-ZB42KE**				4.4	4.7	4.9	5.4
MC-M8-ZB45KE				5.7*	9.0	10.6	14.3	MC-M8-ZB45KE				4.7*	5.2	5.5	6.3
MC-R7-ZB45KE				6.5	9.8	11.8	16.1	MC-R7-ZB45KE				4.5	4.8	5.0	5.5
MC-M9-ZB45KE				6.3	9.5	11.3	15.4	MC-M9-ZB45KE				4.6	5.0	5.2	5.9
MC-R7-ZB58KE				7.1*	12.0	14.4	19.7	MC-R7-ZB58KE				6.1*	6.8	7.2	8.1
MC-S9-ZB58KE				7.5*	12.5	15.1	20.8	MC-S9-ZB58KE				5.9*	6.4	6.7	7.5
MC-S9-ZB66KE				8.6*	13.9	16.5	22.4	MC-S9-ZB66KE				6.7*	7.4	7.8	8.7
MC-V9-ZB66KE				9.0*	14.5	17.3	23.7	MC-V9-ZB66KE				6.5*	7.0	7.3	8.1
MC-V6-ZB76KE				10.9*	17.4	21.0	29.0	MC-V6-ZB76KE				7.4*	8.0	8.4	9.3
MC-V9-ZB76KE				10.3*	16.6	19.8	26.9	MC-V9-ZB76KE				7.5*	8.3	8.8	10.0
MC-V9-ZB95KE				11.2*	18.8	22.5	30.2	MC-V9-ZB95KE				10.2*	11.5	12.3	14.2
MC-W9-ZB114KE				14.1*	23.6	28.5	39.3	MC-W9-ZB114KE				11.9*	13.1	13.8	15.6
MC-V6-ZB114KE				13.8*	23.1	27.9	38.3	MC-V6-ZB114KE				12.2*	13.4	14.1	16.1
Low Temperature Models															
MC-D8-ZF09KE		1.7	2.2	3.2	4.5	5.2		MC-D8-ZF09KE		2.0	2.0	2.2	2.5	2.7	
MC-H8-ZF09KE		1.8	2.3	3.4	4.9	5.7		MC-H8-ZF09KE		1.9	1.9	2.0	2.3	2.5	
MC-H8-ZF13KE		2.5	3.1	4.7	6.7	7.8		MC-H8-ZF13KE		2.6	2.6	2.9	3.4	3.7	
MC-M8-ZF13KE		2.6	3.2	4.9	7.0	8.2		MC-M8-ZF13KE		2.5	2.5	2.8	3.1	3.4	
MC-M9-ZF13KE		2.6	3.3	5.0	7.2	8.5		MC-M9-ZF13KE		2.6	2.6	2.8	3.1	3.4	
MC-H8-ZF15KE		3.0	3.8	5.5	7.6			MC-H8-ZF15KE		3.4	3.6	4.2	5.0		
MC-M8-ZF15KE		3.1	3.9	5.8	8.1	9.4		MC-M8-ZF15KE		3.3	3.4	3.9	4.5	5.0	
MC-R7-ZF15KE		3.2	4.0	6.1	8.7	10.3		MC-R7-ZF15KE		3.3	3.4	3.7	4.3	4.6	
MC-M8-ZF18KE		3.6	4.5	6.7	9.3	10.8		MC-M8-ZF18KE		4.1	4.2	4.6	5.4	5.9	
MC-M9-ZF18KE		3.7	4.6	6.9	9.8	11.5		MC-M9-ZF18KE		4.0	4.0	4.4	5.0	5.4	
MC-S9-ZF18KE		3.8	4.8	7.2	10.4	12.3		MC-S9-ZF18KE		3.8	3.8	4.1	4.6	4.9	
Digital Medium Temperature Models															
MC-M8-ZBD30				4.5	6.8	8.1	11.1	MC-M8-ZBD30				2.7	3.2	3.5	4.1
MC-M9-ZBD45				6.5	9.7	11.6	15.6	MC-M9-ZBD45				4.0	4.8	5.2	6.1
MC-V6-ZBDT60				9.4	14.3	17.1	23.8	MC-V6-ZBDT60				5.8	6.3	6.6	7.4
MC-V6-ZBDT90				13.2	19.9	23.6	32.4	MC-V6-ZBDT90				8.3	9.3	9.9	11.3

Suction Gas Return 20°C / Subcooling 0K

*Suction Superheat 10K, Subcooling 0K

** Single Phase Only

Preliminary Data

Capacity Data

Ambient Temperature: 32°C															
R449A	Cooling Capacity (kW)							R449A	Power Input (kW)						
	Evaporating Temperature (°C)								Evaporating Temperature (°C)						
	-45	-35	-30	-20	-10	-5	+5		-45	-35	-30	-20	-10	-5	+5
Medium Temperature Models															
MC-D8-ZB15KE				2.1	3.2	3.8	5.3	MC-D8-ZB15KE				1.7	1.8	1.8	2.0
MC-H8-ZB15KE				2.2	3.5	4.2	5.9	MC-H8-ZB15KE				1.7	1.7	1.7	1.8
MC-D8-ZB19KE				2.3*	3.7	4.4	6.0	MC-D8-ZB19KE				2.0*	2.1	2.2	2.5
MC-H8-ZB19KE				2.6	4.0	4.8	6.6	MC-H8-ZB19KE				1.9	2.0	2.1	2.3
MC-K9-ZB19KE				2.6	3.9	4.7	6.6	MC-K9-ZB19KE				1.9	2.0	2.0	2.3
MC-D8-ZB21KE				2.9*	4.5	5.3	7.0	MC-D8-ZB21KE				2.4*	2.8	3.0	3.4
MC-H8-ZB21KE				3.3	4.9	5.9	8.1	MC-H8-ZB21KE				2.3	2.5	2.6	2.8
MC-K9-ZB21KE				3.3	4.9	5.9	8.1	MC-K9-ZB21KE				2.3	2.5	2.6	2.9
MC-H8-ZB26KE				3.8	5.6	6.7	9.2	MC-H8-ZB26KE				2.8	3.0	3.1	3.5
MC-K9-ZB26KE				3.7	5.6	6.6	9.1	MC-K9-ZB26KE				2.8	3.0	3.2	3.5
MC-H8-ZB30KE				4.0*	6.4	7.5	10.3	MC-H8-ZB30KE				3.2*	3.6	3.8	4.2
MC-P8-ZB30KE				4.4	6.7	8.0	11.0	MC-P8-ZB30KE				3.1	3.3	3.4	3.8
MC-M8-ZB30KE				4.4	6.7	8.0	10.9	MC-M8-ZB30KE				3.1	3.3	3.5	3.9
MC-P8-ZB38KE				5.1*	8.0	9.5	13.0	MC-P8-ZB38KE				3.9*	4.3	4.5	5.1
MC-M8-ZB38KE				5.0*	8.0	9.4	12.8	MC-M8-ZB38KE				4.0*	4.4	4.6	5.2
MC-H8-ZB38KE				4.7*	7.5	8.8		MC-H8-ZB38KE				4.3*	4.8	5.1	
MC-M8-ZB42KE**				5.5*	8.7	10.3	13.9	MC-M8-ZB42KE**				4.6*	5.2	5.5	6.2
MC-R7-ZB42KE**				6.3	9.5	11.4	15.7	MC-R7-ZB42KE**				4.4	4.7	4.9	5.4
MC-M8-ZB45KE				5.7*	9.0	10.6	14.3	MC-M8-ZB45KE				4.7*	5.2	5.5	6.3
MC-R7-ZB45KE				6.5	9.8	11.8	16.1	MC-R7-ZB45KE				4.5	4.8	5.0	5.5
MC-M9-ZB45KE				6.3	9.5	11.3	15.4	MC-M9-ZB45KE				4.6	5.0	5.2	5.9
MC-R7-ZB58KE				7.1*	12.0	14.4	19.7	MC-R7-ZB58KE				6.1*	6.8	7.2	8.1
MC-S9-ZB58KE				7.5*	12.5	15.1	20.8	MC-S9-ZB58KE				5.9*	6.4	6.7	7.5
MC-S9-ZB66KE				8.6*	13.9	16.5	22.4	MC-S9-ZB66KE				6.7*	7.4	7.8	8.7
MC-V9-ZB66KE				9.0*	14.5	17.3	23.7	MC-V9-ZB66KE				6.4*	7.0	7.3	8.1
MC-V6-ZB76KE				10.9*	17.4	21.0	29.0	MC-V6-ZB76KE				7.4*	8.0	8.4	9.3
MC-V9-ZB76KE				10.3*	16.6	19.8	26.9	MC-V9-ZB76KE				7.5*	8.3	8.8	10.0
MC-V6-ZB95KE				12.3*	20.5	24.5	33.4	MC-V6-ZB95KE				9.9*	10.8	11.4	12.8
MC-V9-ZB95KE				11.2*	18.8	22.5	30.2	MC-V9-ZB95KE				10.2*	11.5	12.3	14.2
MC-V6-ZB114KE				13.7*	23.1	27.9	38.3	MC-V6-ZB114KE				12.2*	13.4	14.1	16.1
MC-W9-ZB114KE				14.1*	23.6	28.5	39.3	MC-W9-ZB114KE				11.9*	13.1	13.8	15.6
Low Temperature Models															
MC-D8-ZF09KE		1.7	2.2	3.2	4.5	5.2		MC-D8-ZF09KE		2.0	2.0	2.2	2.5	2.7	
MC-H8-ZF09KE		1.8	2.3	3.4	4.9	5.7		MC-H8-ZF09KE		1.9	1.9	2.0	2.3	2.5	
MC-H8-ZF13KE		2.5	3.1	4.7	6.7	7.8		MC-H8-ZF13KE		2.6	2.6	2.9	3.4	3.7	
MC-M8-ZF13KE		2.6	3.2	4.9	7.0	8.2		MC-M8-ZF13KE		2.5	2.5	2.8	3.1	3.4	
MC-M9-ZF13KE		2.6	3.3	5.0	7.2	8.5		MC-M9-ZF13KE		2.6	2.6	2.8	3.1	3.4	
MC-H8-ZF15KE		3.0	3.8	5.5	7.6			MC-H8-ZF15KE		3.4	3.6	4.2	5.0		
MC-M8-ZF15KE		3.1	3.9	5.8	8.1	9.4		MC-M8-ZF15KE		3.3	3.4	3.9	4.5	5.0	
MC-R7-ZF15KE		3.2	4.0	6.1	8.7	10.3		MC-R7-ZF15KE		3.3	3.4	3.7	4.3	4.6	
MC-M8-ZF18KE		3.6	4.5	6.7	9.3	10.8		MC-M8-ZF18KE		4.1	4.2	4.6	5.4	5.9	
MC-M9-ZF18KE		3.7	4.6	6.9	9.8	11.5		MC-M9-ZF18KE		4.0	4.0	4.4	5.0	5.4	
MC-S9-ZF18KE		3.8	4.8	7.2	10.4	12.3		MC-S9-ZF18KE		3.8	3.8	4.1	4.6	4.9	
Digital Medium Temperature Models															
MC-M8-ZBD30				4.5	6.8	8.1	11.1	MC-M8-ZBD30				2.7	3.2	3.5	4.1
MC-M9-ZBD45				6.5	9.7	11.6	15.6	MC-M9-ZBD45				4.0	4.8	5.2	6.1
MC-V6-ZBDT60				9.4	14.3	17.1	23.8	MC-V6-ZBDT60				5.8	6.3	6.6	7.4
MC-V6-ZBDT90				13.2	19.9	23.6	32.4	MC-V6-ZBDT90				8.3	9.3	9.9	11.3

Suction Gas Return 20°C / Subcooling 0K

*Suction Superheat 10K, Subcooling 0K

** Single Phase Only

Preliminary Data

Capacity Data

Ambient Temperature: 32°C															
R404A	Cooling Capacity (kW)							R404A	Power Input (kW)						
	Evaporating Temperature (°C)								Evaporating Temperature (°C)						
	-45	-35	-30	-20	-10	-5	+5		-45	-35	-30	-20	-10	-5	+5
Medium Temperature Models															
MC-H8-ZB15KE				2.5	3.6	4.3	5.8	MC-H8-ZB15KE				1.9	1.9	1.9	1.9
MC-D8-ZB15KE				2.2	3.3	3.8	5.0	MC-D8-ZB15KE				1.9	2.0	2.0	2.1
MC-K9-ZB19KE				2.9	4.1	4.8	6.5	MC-K9-ZB19KE				2.1	2.2	2.2	2.4
MC-H8-ZB19KE				2.9	4.1	4.8	6.5	MC-H8-ZB19KE				2.1	2.2	2.3	2.4
MC-D8-ZB19KE				2.6	3.7	4.3	5.6	MC-D8-ZB19KE				2.2	2.4	2.5	2.6
MC-H8-ZB21KE				3.6	5.1	5.9	7.8	MC-H8-ZB21KE				2.6	2.7	2.8	3.0
MC-K9-ZB21KE				3.6	5.1	5.9	7.8	MC-K9-ZB21KE				2.6	2.7	2.8	3.0
MC-D8-ZB21KE				3.2	4.4	5.0	6.4	MC-D8-ZB21KE				2.8	3.1	3.2	3.5
MC-K9-ZB26KE				4.1	5.7	6.6	8.7	MC-K9-ZB26KE				3.1	3.3	3.4	3.6
MC-H8-ZB26KE				4.1	5.7	6.6	8.6	MC-H8-ZB26KE				3.1	3.3	3.4	3.7
MC-H8-ZB30KE				4.6	6.4	7.4	9.6	MC-H8-ZB30KE				3.7	3.9	4.1	4.4
MC-P8-ZB30KE				5.0	7.1	8.3	11.1	MC-P8-ZB30KE				3.3	3.5	3.5	3.8
MC-M8-ZB30KE				4.8	6.8	7.9	10.5	MC-M8-ZB30KE				3.4	3.6	3.7	4.0
MC-H8-ZB38KE				5.3	7.3	8.4	10.7	MC-H8-ZB38KE				4.8	5.2	5.4	6.0
MC-P8-ZB38KE				6.0	8.4	9.7	12.9	MC-P8-ZB38KE				4.2	4.5	4.7	5.1
MC-M8-ZB38KE				5.7	8.0	9.2	12.0	MC-M8-ZB38KE				4.4	4.8	5.0	5.4
MC-R7-ZB42KE**				6.9	9.8	11.4	15.1	MC-R7-ZB42KE**				4.8	5.1	5.2	5.6
MC-M8-ZB42KE**				6.3	8.7	10.0	12.8	MC-M8-ZB42KE**				5.1	5.6	5.8	6.3
MC-R7-ZB45KE				7.1	10.1	11.8	15.6	MC-R7-ZB45KE				5.0	5.3	5.4	5.8
MC-M8-ZB45KE				6.5	8.9	10.3	13.2	MC-M8-ZB45KE				5.3	5.7	6.0	6.5
MC-M9-ZB45KE				6.9	9.6	11.1	14.5	MC-M9-ZB45KE				5.1	5.5	5.7	6.1
MC-S9-ZB50KE				7.9	12.0	14.2	18.9	MC-S9-ZB50KE				5.8	6.1	6.3	6.7
MC-R7-ZB50KE				7.5	11.4	13.4	17.7	MC-R7-ZB50KE				6.0	6.5	6.7	7.2
MC-R7-ZB58KE				8.5	12.4	14.5	18.8	MC-R7-ZB58KE				6.7	7.3	7.6	8.3
MC-S9-ZB58KE				8.9	13.1	15.4	20.3	MC-S9-ZB58KE				6.4	6.9	7.1	7.7
MC-S9-ZB66KE				10.3	14.5	16.8	21.7	MC-S9-ZB66KE				7.4	7.9	8.2	8.9
MC-V9-ZB66KE				10.7	15.1	17.6	23.0	MC-V9-ZB66KE				7.1	7.6	7.8	8.5
MC-V6-ZB76KE				12.9	18.5	21.6	28.7	MC-V6-ZB76KE				8.0	8.6	8.9	9.6
MC-V9-ZB76KE				12.2	17.2	19.9	25.8	MC-V9-ZB76KE				8.3	9.0	9.4	10.3
MC-V6-ZB95KE				14.9	21.5	25.2	33.1	MC-V6-ZB95KE				10.7	11.4	11.9	13.0
MC-V9-ZB95KE				12.2*	19.3	22.4	28.7	MC-V9-ZB95KE				11.2*	12.4	13.0	14.3
MC-W9-ZB114KE				16.8	24.6	28.8	38.0	MC-W9-ZB114KE				13.2	14.1	14.6	16.0
MC-V6-ZB114KE				15.1*	24.3	28.4	37.3	MC-V6-ZB114KE				13.1*	14.3	14.8	16.2

Suction Gas Return 20°C / Subcooling 0K

*Suction Superheat 10K, Subcooling 0K

** Single Phase Only

Capacity Data

Ambient Temperature: 32°C															
R404A	Cooling Capacity (kW)							R404A	Power Input (kW)						
	Evaporating Temperature (°C)								Evaporating Temperature (°C)						
	-45	-35	-30	-20	-10	-5	+5		-45	-35	-30	-20	-10	-5	+5
Low Temperature Models															
MC-B8-ZF06KE		1.3	1.6	2.2	2.9	3.2		MC-B8-ZF06KE		1.7	1.8	2.1	2.4	2.6	
MC-D8-ZF09KE		1.9	2.3	3.3	4.4	5.0	6.3	MC-D8-ZF09KE		2.0	2.1	2.3	2.6	2.8	3.2
MC-H8-ZF09KE		2.0	2.5	3.6	4.9	5.7	7.5	MC-H8-ZF09KE		2.0	2.0	2.2	2.5	2.6	3.0
MC-H8-ZF11KE		2.5	3.0	4.3	5.8	6.7	8.7	MC-H8-ZF11KE		2.4	2.5	2.7	3.1	3.3	3.8
MC-M9-ZF13KE		2.9	3.6	5.3	7.3	8.5	11.2	MC-M9-ZF13KE		2.6	2.7	3.0	3.4	3.6	4.1
MC-H8-ZF13KE		2.8	3.4	4.9	6.6	7.6	9.7	MC-H8-ZF13KE		2.6	2.7	3.1	3.5	3.8	4.3
MC-M8-ZF13KE		2.8	3.5	5.1	7.0	8.1	10.6	MC-M8-ZF13KE		2.5	2.6	2.9	3.3	3.6	4.1
MC-R7-ZF15KE		3.5	4.4	6.4	8.9	10.4	13.6	MC-R7-ZF15KE		3.4	3.6	4.0	4.5	4.9	5.7
MC-M8-ZF15KE		3.4	4.2	5.9	8.1	9.2	11.7	MC-M8-ZF15KE		3.3	3.5	4.0	4.7	5.1	6.0
MC-H8-ZF15KE		3.3	4.0	5.6	7.4	8.4		MC-H8-ZF15KE		3.4	3.7	4.3	5.0	5.5	
MC-M8-ZF18KE		3.9	4.8	6.8	9.2	10.5	13.3	MC-M8-ZF18KE		4.0	4.3	4.8	5.5	5.9	6.8
MC-M9-ZF18KE		4.0	5.0	7.2	9.8	11.3	14.6	MC-M9-ZF18KE		4.0	4.2	4.6	5.2	5.6	6.4
MC-S9-ZF18KE		4.2	5.2	7.6	10.6	12.4	16.5	MC-S9-ZF18KE		3.8	4.0	4.4	4.9	5.2	5.9
MC-S9-ZF25K5		5.3	6.5	9.3	13.0	15.1	19.8	MC-S9-ZF25K5		4.2	4.5	5.2	6.1	6.5	7.5
MC-S9-ZF34K5		6.7	8.3	11.9	16.1	18.5		MC-S9-ZF34K5		5.6	6.0	7.1	8.3	9.1	
MC-V6-ZF41K5		8.6	10.6	15.4	21.4	24.8	32.6	MC-V6-ZF41K5		7.0	7.5	8.7	10.1	10.8	12.4
MC-V6-ZF49K5		10.2	12.5	18.1	24.8	28.7		MC-V6-ZF49K5		8.4	8.9	10.3	12.1	13.1	
Digital Medium Temperature Models															
MC-M8-ZBD30				5.0	6.9	8.0	10.5	MC-M8-ZBD30				3.0	3.4	3.6	4.0
MC-M9-ZBD45				7.1	9.8	11.4	14.6	MC-M9-ZBD45				4.5	5.2	5.6	6.4
MC-V6-ZBDT60				10.4	14.9	17.6	23.6	MC-V6-ZBDT60				6.3	6.7	7.0	7.5
MC-V6-ZBDT90				14.1	20.4	24.1	32.5	MC-V6-ZBDT90				9.6	10.4	10.8	11.9

Suction Gas Return 20°C / Subcooling 0K

*Suction Superheat 10K, Subcooling 0K

** Single Phase Only

Preliminary Data

Capacity Data

Ambient Temperature: 32°C															
R407C	Cooling Capacity (kW)							R407C	Power Input (kW)						
	Evaporating Temperature (°C)								Evaporating Temperature (°C)						
	-45	-35	-30	-20	-10	-5	+5		-45	-35	-30	-20	-10	-5	+5
Medium Temperature Models															
MC-D8-ZB15KE				1.8*	3.0	3.6	5.1	MC-D8-ZB15KE				1.6*	1.6	1.7	1.8
MC-H8-ZB15KE				1.9*	3.2	3.9	5.6	MC-H8-ZB15KE				1.6*	1.6	1.6	1.7
MC-H8-ZB19KE				2.2*	3.5	4.3	6.3	MC-H8-ZB19KE				1.7*	1.8	1.9	2.0
MC-D8-ZB19KE				2.0*	3.2*	4.0	5.7	MC-D8-ZB19KE				1.7*	1.9*	2.0	2.2
MC-K9-ZB19KE				2.2*	3.5	4.3	6.3	MC-K9-ZB19KE				1.7*	1.8	1.9	2.0
MC-H8-ZB21KE				2.9*	4.6	5.5	7.8	MC-H8-ZB21KE				2.1*	2.3	2.4	2.6
MC-K9-ZB21KE				2.8*	4.6	5.5	7.7	MC-K9-ZB21KE				2.1*	2.3	2.4	2.6
MC-D8-ZB21KE				2.6*	4.0*	4.9*	6.8	MC-D8-ZB21KE				2.2*	2.5*	2.6*	3.0
MC-H8-ZB26KE				3.3*	5.1*	6.3	8.8	MC-H8-ZB26KE				2.5*	2.7*	2.9	3.2
MC-K9-ZB26KE				3.3*	5.1*	6.2	8.7	MC-K9-ZB26KE				2.5*	2.7*	2.9	3.2
MC-M8-ZB30KE				4.2*	6.2*	7.5	10.4	MC-M8-ZB30KE				2.8*	3.2*	3.3	3.7
MC-H8-ZB30KE				4.0*	5.9*	7.1	9.7	MC-H8-ZB30KE				3.0*	3.4*	3.6	4.0
MC-P8-ZB30KE				4.2*	6.3	7.5	10.5	MC-P8-ZB30KE				2.8*	3.1	3.3	3.6
MC-M8-ZB38KE				4.9*	7.5*	9.1	12.3	MC-M8-ZB38KE				3.6*	3.9*	4.2	4.7
MC-H8-ZB38KE					7.0*	8.4*	11.4	MC-H8-ZB38KE					4.3*	4.5*	5.3
MC-P8-ZB38KE				4.9*	7.5*	9.1	12.5	MC-P8-ZB38KE				3.6*	3.9*	4.1	4.6
MC-R7-ZB42KE**				5.7*	8.8	10.5	14.7	MC-R7-ZB42KE**				4.3*	4.6	4.7	4.8
MC-M8-ZB42KE**				5.3*	7.9*	9.4*	13.0	MC-M8-ZB42KE**				4.5*	4.9*	5.1*	5.6
MC-R7-ZB45KE				5.8*	9.1	11.1	15.5	MC-R7-ZB45KE				4.1*	4.5	4.7	5.1
MC-M8-ZB45KE				5.4*	8.2*	9.8*	13.8	MC-M8-ZB45KE				4.3*	4.8*	5.1*	5.9
MC-M9-ZB45KE				5.6*	8.7*	10.7	14.8	MC-M9-ZB45KE				4.2*	4.6*	4.9	5.5
MC-S9-ZB50KE				6.3*	10.5	12.8	17.8	MC-S9-ZB50KE				4.9*	5.2	5.4	6.0
MC-R7-ZB50KE				5.9*	10.0	12.3	17.1	MC-R7-ZB50KE				5.1*	5.5	5.7	6.3
MC-V9-ZB66KE				9.0*	13.8	16.5	23.0	MC-V9-ZB66KE				5.8*	6.4	6.7	7.3
MC-S9-ZB66KE					13.3	15.9	22.0	MC-S9-ZB66KE					6.7	7.1	7.9
MC-V6-ZB76KE				10.4*	16.3	19.7	27.6	MC-V6-ZB76KE				6.9*	7.5	7.7	8.5
MC-V9-ZB76KE				10.0*	15.6	18.7	26.0	MC-V9-ZB76KE				6.9*	7.7	8.1	9.1
MC-W9-ZB114KE				13.6*	22.2	26.9	37.7	MC-W9-ZB114KE				10.7*	11.9	12.5	14.0

Suction Gas Return 20°C / Subcooling 0K

*Suction Superheat 10K, Subcooling 0K

** Single Phase Only

Preliminary Data

Capacity Data

Ambient Temperature: 32°C															
R134a	Cooling Capacity (kW)							R134a	Power Input (kW)						
	Evaporating Temperature (°C)								Evaporating Temperature (°C)						
	-45	-35	-30	-20	-10	-5	+5		-45	-35	-30	-20	-10	-5	+5
Medium Temperature Models															
MC-D8-ZB15KE				1.4	2.2	2.7	3.9	MC-D8-ZB15KE				1.0	1.0	1.1	1.2
MC-H8-ZB15KE				1.4	2.3	2.8	4.1	MC-H8-ZB15KE				1.1	1.1	1.1	1.2
MC-H8-ZB19KE				1.6	2.6	3.2	4.7	MC-H8-ZB19KE				1.2	1.3	1.3	1.4
MC-K9-ZB19KE				1.6	2.6	3.2	4.7	MC-K9-ZB19KE				1.2	1.2	1.3	1.3
MC-D8-ZB19KE				1.6	2.5	3.1	4.4	MC-D8-ZB19KE				1.1	1.2	1.3	1.4
MC-H8-ZB21KE				2.1	3.2	4.0	5.7	MC-H8-ZB21KE				1.5	1.5	1.6	1.7
MC-K9-ZB21KE				2.1	3.2	4.0	5.8	MC-K9-ZB21KE				1.4	1.5	1.6	1.7
MC-D8-ZB21KE				1.9*	3.1	3.7	5.3	MC-D8-ZB21KE				1.4*	1.5	1.6	1.8
MC-H8-ZB26KE				2.3	3.7	4.5	6.5	MC-H8-ZB26KE				1.7	1.8	1.8	2.0
MC-K9-ZB26KE				2.4	3.7	4.5	6.5	MC-K9-ZB26KE				1.6	1.7	1.8	1.9
MC-M8-ZB30KE				2.8	4.4	5.3	7.7	MC-M8-ZB30KE				1.9	2.0	2.0	2.2
MC-P8-ZB30KE				2.8	4.4	5.4	7.8	MC-P8-ZB30KE				1.8	1.9	2.0	2.1
MC-H8-ZB30KE				2.7	4.2	5.2	7.4	MC-H8-ZB30KE				1.9	2.0	2.1	2.3
MC-P8-ZB38KE				3.3	5.4	6.6	9.5	MC-P8-ZB38KE				2.2	2.4	2.5	2.7
MC-M8-ZB38KE				3.3	5.3	6.5	9.3	MC-M8-ZB38KE				2.2	2.4	2.5	2.8
MC-H8-ZB38KE				3.0*	5.1	6.3	8.9	MC-H8-ZB38KE				2.3*	2.6	2.7	3.0
MC-R7-ZB42KE**				3.9	6.1	7.5	10.8	MC-R7-ZB42KE**				2.8	2.9	2.9	2.9
MC-M8-ZB42KE**				3.8	5.9	7.1	10.1	MC-M8-ZB42KE**				2.8	2.9	3.0	3.1
MC-M8-ZB45KE				4.0	6.2	7.6	10.9	MC-M8-ZB45KE				2.7	2.9	3.0	3.3
MC-M9-ZB45KE				4.1	6.4	7.8	11.3	MC-M9-ZB45KE				2.7	2.9	3.0	3.3
MC-R7-ZB45KE				4.2	6.5	8.0	11.6	MC-R7-ZB45KE				2.8	2.9	3.0	3.2
MC-R7-ZB50KE				4.7	7.3	8.9	12.8	MC-R7-ZB50KE				3.4	3.5	3.7	4.0
MC-S9-ZB50KE				4.8	7.5	9.1	13.1	MC-S9-ZB50KE				3.3	3.4	3.5	3.8
MC-S9-ZB58KE				5.3	8.3	10.2	14.6	MC-S9-ZB58KE				3.7	3.8	4.0	4.3
MC-R7-ZB58KE				5.2	8.1	9.9	14.1	MC-R7-ZB58KE				3.8	4.0	4.1	4.5
MC-S9-ZB66KE				6.1	9.4	11.4	16.4	MC-S9-ZB66KE				4.1	4.3	4.5	4.9
MC-V9-ZB66KE				6.2	9.5	11.6	16.7	MC-V9-ZB66KE				4.0	4.2	4.4	4.7
MC-V9-ZB76KE				7.0	10.8	13.1	18.8	MC-V9-ZB76KE				4.7	4.9	5.2	5.6
MC-V6-ZB76KE				7.1	11.1	13.6	19.6	MC-V6-ZB76KE				4.9	5.0	5.2	5.6
MC-V9-ZB95KE				8.3	13.3	16.2	22.9	MC-V9-ZB95KE				5.9	6.4	6.7	7.4
MC-V6-ZB95KE				8.6	13.8	16.9	24.2	MC-V6-ZB95KE				5.9	6.3	6.5	7.1
MC-V6-ZB114KE				9.9	16.1	19.8	28.4	MC-V6-ZB114KE				7.2	7.6	8.0	8.7
MC-W9-ZB114KE				9.9	16.2	20.0	28.7	MC-W9-ZB114KE				7.1	7.6	7.9	8.6
Digital Medium Temperature Models															
MC-M8-ZBD30				2.9	4.5	5.4	7.6	MC-M8-ZBD30				1.8	2.0	2.1	2.4
MC-M9-ZBD45				3.9*	6.4	7.7	11.0	MC-M9-ZBD45				2.6*	3.0	3.1	3.5
MC-V6-ZBDT60				5.8	9.1	11.1	16.0	MC-V6-ZBDT60				3.9	4.1	4.3	4.6
MC-V6-ZBDT90				8.4	13.0	15.9	22.9	MC-V6-ZBDT90				5.2	5.7	6.0	6.6

Suction Gas Return 20°C / Subcooling 0K

*Suction Superheat 10K, Subcooling 0K

** Single Phase Only

Preliminary Data

Capacity Data

Ambient Temperature: 32°C															
R450A	Cooling Capacity (kW)							R450A	Power Input (kW)						
	Evaporating Temperature (°C)								Evaporating Temperature (°C)						
	-45	-35	-30	-20	-10	-5	+5		-45	-35	-30	-20	-10	-5	+5
Medium Temperature Models															
MC-D8-ZB15KE				1.2	1.9	2.4	3.5	MC-D8-ZB15KE				0.9	0.9	0.9	0.9
MC-H8-ZB15KE				1.2	2.0	2.5	3.7	MC-H8-ZB15KE				1.0	1.0	1.0	1.0
MC-D8-ZB19KE				1.4	2.2	2.7	4.0	MC-D8-ZB19KE				1.1	1.1	1.1	1.2
MC-H8-ZB19KE				1.4	2.3	2.8	4.2	MC-H8-ZB19KE				1.1	1.1	1.1	1.2
MC-K9-ZB19KE				1.4	2.3	2.8	4.2	MC-K9-ZB19KE				1.1	1.1	1.1	1.2
MC-D8-ZB21KE				1.6*	2.8	3.4	4.9	MC-D8-ZB21KE				1.3*	1.3	1.4	1.5
MC-H8-ZB21KE				1.8	2.9	3.6	5.3	MC-H8-ZB21KE				1.3	1.4	1.4	1.4
MC-K9-ZB21KE				1.8	2.9	3.6	5.3	MC-K9-ZB21KE				1.3	1.3	1.3	1.4
MC-H8-ZB26KE				2.1	3.3	4.1	6.0	MC-H8-ZB26KE				1.5	1.6	1.6	1.7
MC-K9-ZB26KE				2.1	3.3	4.1	6.0	MC-K9-ZB26KE				1.5	1.5	1.6	1.7
MC-H8-ZB30KE				2.4	3.8	4.7	6.9	MC-H8-ZB30KE				1.8	1.8	1.8	1.9
MC-M8-ZB30KE				2.4	3.9	4.9	7.1	MC-M8-ZB30KE				1.7	1.7	1.8	1.8
MC-P8-ZB30KE				2.5	4.0	4.9	7.2	MC-P8-ZB30KE				1.7	1.7	1.7	1.8
MC-H9-ZB38KE				2.7*	4.6	5.7	8.2	MC-H9-ZB38KE				2.2*	2.3	2.4	2.6
MC-M8-ZB38KE				3.0	4.8	5.9	8.6	MC-M8-ZB38KE				2.1	2.2	2.2	2.4
MC-P8-ZB38KE				3.0	4.8	6.0	8.7	MC-P8-ZB38KE				2.1	2.1	2.2	2.3
MC-M8-ZB42KE**				3.3	5.3	6.5	9.4	MC-M8-ZB42KE**				2.4	2.5	2.5	2.7
MC-R7-ZB42KE**				3.4	5.5	6.8	10.0	MC-R7-ZB42KE**				2.5	2.5	2.6	2.7
MC-M8-ZB45KE				3.5	5.5	6.8	9.8	MC-M8-ZB45KE				2.5	2.5	2.6	2.8
MC-M9-ZB45KE				3.5	5.7	7.0	10.2	MC-M9-ZB45KE				2.6	2.6	2.7	2.8
MC-R7-ZB45KE				3.6	5.8	7.1	10.5	MC-R7-ZB45KE				2.6	2.6	2.7	2.8
MC-R7-ZB58KE				4.5	7.2	8.8	12.7	MC-R7-ZB58KE				3.3	3.6	3.8	4.1
MC-S9-ZB58KE				4.6	7.3	8.9	13.0	MC-S9-ZB58KE				3.3	3.5	3.7	4.0
MC-S9-ZB66KE				5.1	8.1	9.9	14.4	MC-S9-ZB66KE				3.6	3.9	4.1	4.5
MC-V9-ZB66KE				5.2	8.2	10.1	14.6	MC-V9-ZB66KE				3.6	3.9	4.0	4.4
MC-V6-ZB76KE				6.0	9.7	11.9	17.4	MC-V6-ZB76KE				4.4	4.7	4.9	5.2
MC-V9-ZB76KE				5.9	9.4	11.6	16.9	MC-V9-ZB76KE				4.1	4.5	4.7	5.2
MC-V6-ZB95KE				7.3	11.8	14.5	21.3	MC-V6-ZB95KE				5.4	5.7	6.0	6.7
MC-V9-ZB95KE				7.1	11.3	14.0	20.3	MC-V9-ZB95KE				5.3	5.7	6.0	6.8
MC-V6-ZB114KE				8.4	13.8	17.0	24.8	MC-V6-ZB114KE				6.5	7.0	7.3	8.1
MC-W9-ZB114KE				8.5	13.8	17.1	25.0	MC-W9-ZB114KE				6.5	7.0	7.3	8.0
Digital Medium Temperature Models															
MC-M8-ZBD30				2.5	4.0	4.9	7.1	MC-M8-ZBD30				1.5	1.7	1.8	2.0
MC-M9-ZBD45				3.6	5.8	7.1	10.2	MC-M9-ZBD45				2.3	2.6	2.7	3.0
MC-V6-ZBDT60				5.0	8.1	10.1	14.8	MC-V6-ZBDT60				3.5	3.6	3.7	4.0
MC-V6-ZBDT90				7.3	11.6	14.3	21.0	MC-V6-ZBDT90				4.8	5.1	5.2	5.7

Suction Gas Return 20°C / Subcooling 0K

*Suction Superheat 10K, Subcooling 0K

** Single Phase Only

Preliminary Data

Capacity Data

Ambient Temperature: 32°C															
R513A	Cooling Capacity (kW)							R513A	Power Input (kW)						
	Evaporating Temperature (°C)								Evaporating Temperature (°C)						
	-45	-35	-30	-20	-10	-5	+5		-45	-35	-30	-20	-10	-5	+5
Medium Temperature Models															
MC-D8-ZB15KE				1.4	2.3	2.8	4.0	MC-D8-ZB15KE				1.1	1.1	1.1	1.1
MC-H8-ZB15KE				1.5	2.4	2.9	4.2	MC-H8-ZB15KE				1.1	1.1	1.1	1.1
MC-D8-ZB19KE				1.6*	2.6	3.2	4.4	MC-D8-ZB19KE				1.2*	1.3	1.3	1.4
MC-H8-ZB19KE				1.8	2.8	3.3	4.8	MC-H8-ZB19KE				1.3	1.3	1.3	1.4
MC-K9-ZB19KE				1.8	2.8	3.4	4.8	MC-K9-ZB19KE				1.3	1.3	1.3	1.4
MC-D8-ZB21KE				2.0*	3.3	3.9	5.3	MC-D8-ZB21KE				1.5*	1.6	1.7	1.8
MC-H8-ZB21KE				2.3	3.5	4.2	5.9	MC-H8-ZB21KE				1.5	1.6	1.6	1.7
MC-K9-ZB21KE				2.3	3.5	4.2	5.9	MC-K9-ZB21KE				1.5	1.6	1.6	1.7
MC-H8-ZB26KE				2.5	3.9	4.7	6.8	MC-H8-ZB26KE				1.8	1.9	1.9	2.0
MC-K9-ZB26KE				2.5	3.9	4.8	6.8	MC-K9-ZB26KE				1.8	1.8	1.9	2.0
MC-H8-ZB30KE				2.7*	4.5	5.5	7.8	MC-H8-ZB30KE				2.0*	2.1	2.2	2.4
MC-M8-ZB30KE				3.0	4.6	5.7	8.2	MC-M8-ZB30KE				2.0	2.0	2.1	2.2
MC-P8-ZB30KE				3.0	4.7	5.8	8.3	MC-P8-ZB30KE				1.9	2.0	2.0	2.1
MC-H9-ZB38KE				3.2*	5.4	6.5	9.2	MC-H9-ZB38KE				2.6*	2.8	2.9	3.1
MC-M8-ZB38KE				3.4*	5.6	6.8	9.7	MC-M8-ZB38KE				2.5*	2.6	2.7	2.9
MC-P8-ZB38KE				3.7	5.7	7.0	10.0	MC-P8-ZB38KE				2.5	2.6	2.6	2.8
MC-M8-ZB42KE**				3.7*	6.2	7.6	10.7	MC-M8-ZB42KE**				2.8*	3.0	3.1	3.3
MC-R7-ZB42KE**				4.2	6.6	8.0	11.5	MC-R7-ZB42KE**				2.9	3.0	3.0	3.2
MC-M8-ZB45KE				3.9*	6.5	7.8	11.1	MC-M8-ZB45KE				2.9*	3.1	3.2	3.4
MC-M9-ZB45KE				4.3	6.7	8.1	11.6	MC-M9-ZB45KE				3.0	3.1	3.2	3.4
MC-R7-ZB45KE				4.4	6.8	8.3	12.0	MC-R7-ZB45KE				3.0	3.1	3.1	3.3
MC-R7-ZB58KE				5.5	8.4	10.2	14.4	MC-R7-ZB58KE				3.9	4.1	4.3	4.7
MC-S9-ZB58KE				5.5	8.6	10.5	14.9	MC-S9-ZB58KE				3.9	4.0	4.1	4.5
MC-S9-ZB66KE				6.2	9.6	11.6	16.4	MC-S9-ZB66KE				4.3	4.5	4.7	5.1
MC-V9-ZB66KE				6.3	9.7	11.8	16.8	MC-V9-ZB66KE				4.3	4.4	4.5	4.9
MC-V6-ZB76KE				7.4	11.5	14.0	20.2	MC-V6-ZB76KE				5.1	5.3	5.5	5.8
MC-V9-ZB76KE				7.2	11.2	13.6	19.3	MC-V9-ZB76KE				4.9	5.2	5.4	5.9
MC-V6-ZB95KE				8.9	14.0	17.1	24.3	MC-V6-ZB95KE				6.4	6.7	6.9	7.4
MC-V9-ZB95KE				8.6	13.4	16.2	22.8	MC-V9-ZB95KE				6.3	6.8	7.1	7.8
MC-V6-ZB114KE				10.1	16.3	19.9	28.1	MC-V6-ZB114KE				7.8	8.2	8.5	9.1
MC-W9-ZB114KE				10.2	16.4	20.0	28.3	MC-W9-ZB114KE				7.7	8.2	8.4	9.0
MC-V6-ZB114KE			10.2					MC-V6-ZB114KE							
Digital Medium Temperature Models															
MC-M8-ZBD30				3.0	4.7	5.7	8.1	MC-M8-ZBD30				1.8	2.0	2.1	2.3
MC-M9-ZBD45				4.4	6.8	8.2	11.6	MC-M9-ZBD45				2.7	3.0	3.2	3.6
MC-V6-ZBDT60				6.2	9.6	11.9	17.2	MC-V6-ZBDT60				4.0	4.2	4.3	4.6
MC-V6-ZBDT90				8.8	13.7	16.8	24.0	MC-V6-ZBDT90				5.6	6.0	6.2	6.7

Suction Gas Return 20°C / Subcooling 0K

*Suction Superheat 10K, Subcooling 0K

** Single Phase Only

Preliminary Data

Copeland Scroll Digital™ Receiver Unit HLR

Copeland Scroll Digital Receiver Units are the perfect choice for remote condenser systems.

These Scroll Digital Receiver Units are an innovative offering by Emerson for food service and retail businesses. Their compact design and the power of Digital Scroll continuous capacity modulation allow for optimized environmental integration at highest system efficiency.

Eight models with single or tandem compressors cover the need of medium temperature refrigeration capacities in various applications. The continuous capacity modulation always provides the right performance, especially for systems with multiple evaporators and variable loads. The remote condenser concept allows for optimal building integration.



Digital Receiver Unit HLR



Digital Receiver Unit HLR Line-up

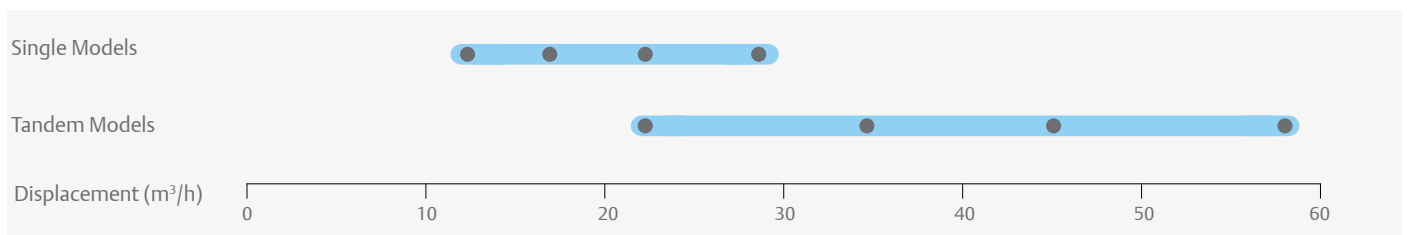

Features and Benefits

- Standard equipment: Digital Scroll compressor, liquid receiver, liquid line with filter drier and sight glass, HP/LP switch, complete electrical box including controller with overload protection and communication interface
- Continuous capacity modulation 10-100 % (Single) or 5-100 % (Tandem)
- Precise suction pressure control
- Maximum system flexibility by free choice of third party condensers
- Excellent energy efficiency
- High reliability
- Easy and quick installation
- Suitable for multiple refrigerants: R407A/F, R448A/R449A, R404A, R134a, R450A and R513A

Maximum Allowable Pressures (PS)

- Low Side PS 22.5 bar (g)
- High Side PS = 28/32 bar (g)

Technical Overview

Models	Displacement (m ³ /h)	Receiver Capacity (l)	Suction Line Diameter (inch)	Liquid Line Diameter (inch)	Width/Depth/Height (mm)	Net Weight (kg)	Motor Version/Code		Maximum Operating Current (A)		Locked Rotor Current (A)		Sound Pressure @1 m - dB(A)***	
							1 Ph*	3 Ph**	1 Ph*	3 Ph**	1 Ph*	3 Ph**	Without Sound Shell	With Sound Shell
Single Compressor Unit Models														
HLR13-ZBD30KE	11.7	13	7/8	5/8	690/400/710	72	TFD		8		52		59	49
HLR13-ZBD45KE	17.1	13	7/8	5/8	690/400/710	75	TFD		12		74		61	51
HLR13-ZBD58KE	22.1	13	1 1/8	3/4	725/400/710	84	TFD		15		95		65	55
HLR13-ZBD76KE	28.8	13	1 3/8	3/4	725/400/710	90	TFD		20		118		66	56
Tandem Compressor Unit Models														
HLR31-ZBDT60KE	23.4	31	1 3/8	7/8	970/480/910	130	TFD		8+8		52 + 52		62	-
HLR31-ZBDT90KE	34.1	31	1 3/8	7/8	970/480/910	138	TFD		12 + 12		74 + 74		64	-
HLR31-ZBDT116KE	44.2	31	1 5/8	1 1/8	970/480/870	165	TFD		15 + 15		95 + 95		68	-
HLR31-ZBDT152KE	58.2	31	1 5/8	1 3/8	970/480/870	175	TFD		20 + 20		118 + 118		69	-

Capacity Data

Condensing Temperature: 40°C															
R407A	Cooling Capacity (kW)							R407A	Power Input (kW)						
	Evaporating Temperature (°C)								Evaporating Temperature (°C)						
Model	-45	-35	-30	-20	-10	-5	+5	Model	-45	-35	-30	-20	-10	-5	+5
Single Compressor Unit Models															
HLR13-ZBD30KCE				4.0*	6.8	8.4	12.4	HLR13-ZBD30KCE				3.2*	3.1	3.2	3.2
HLR13-ZBD45KCE				5.5*	9.4	11.7	17.2	HLR13-ZBD45KCE				4.4*	4.3	4.4	4.4
Tandem Compressor Unit Models															
HLR31-ZBDT60KCE				8.0*	13.6	16.8	24.6	HLR31-ZBDT60KCE				6.2*	6.2	6.2	6.3
HLR31-ZBDT90KCE				11.4*	18.9	23.2	34.1	HLR31-ZBDT90KCE				8.7*	8.8	8.8	8.8

Conditions: EN13215: Suction Gas Return 20°C, Subcooling 0K

* Suction Superheat 10K

Preliminary Data

Condensing Temperature: 40°C															
R407F	Cooling Capacity (kW)							R407F	Power Input (kW)						
	Evaporating Temperature (°C)								Evaporating Temperature (°C)						
Model	-45	-35	-30	-20	-10	-5	+5	Model	-45	-35	-30	-20	-10	-5	+5
HLR13-ZBD30KCE			2.8*	4.8	7.3	8.8	12.8	HLR13-ZBD30KCE			2.0*	2.5	2.8	2.9	3.1
HLR13-ZBD45KCE				6.4*	10.8	13.2	18.9	HLR13-ZBD45KCE				3.7*	4.1	4.3	4.6
HLR31-ZBDT60KCE				8.9*	14.5	17.7	25.7	HLR31-ZBDT60KCE				5.4*	5.7	5.8	6.0
HLR31-ZBDT90KCE				12.4*	21.2	26.1	37.9	HLR31-ZBDT90KCE				7.8*	8.4	8.5	8.8

Conditions: EN12900: Condensing Temperature 45°C, Suction Gas Return 20°C, Subcooling 0K

*Conditions: EN12900: Condensing Temperature 45°C, Suction Superheat 10K

Condensing Temperature: 40°C															
R448A	Cooling Capacity (kW)							R448A	Power Input (kW)						
	Evaporating Temperature (°C)								Evaporating Temperature (°C)						
Model	-45	-35	-30	-20	-10	-5	+5	Model	-45	-35	-30	-20	-10	-5	+5
Single Compressor Unit Models															
HLR13-ZBD30KCE				4.1*	6.8	8.3	12.1	HLR13-ZBD30KCE				2.7*	3.0	3.1	3.4
HLR13-ZBD45KCE				6.0*	10.0	12.2	17.7	HLR13-ZBD45KCE				3.8*	4.2	4.4	4.8
Tandem Compressor Unit Models															
HLR31-ZBDT60KCE				8.2*	13.5	16.6	24.2	HLR31-ZBDT60KCE				5.4*	5.9	6.2	6.8
HLR31-ZBDT90KCE				12.0*	20	24.4	35.4	HLR31-ZBDT90KCE				7.6*	8.4	8.8	9.6
HLR31-ZBDT116KCE				13.7*	25.5	31.7	46.2	HLR31-ZBDT116KCE				11.9*	11.8	11.9	12.1
HLR31-ZBDT152KCE				19.8*	34.9	43.10	62.5	HLR31-ZBDT152KCE				15.8*	16.0	16.10	16.5

Conditions: EN13215: Suction Gas Return 20°C, Subcooling 0K

* Suction Superheat 10K

Preliminary Data

Capacity Data

Condensing Temperature: 40°C															
R449A	Cooling Capacity (kW)							R449A	Power Input (kW)						
	Evaporating Temperature (°C)								Evaporating Temperature (°C)						
Model	-45	-35	-30	-20	-10	-5	+5	Model	-45	-35	-30	-20	-10	-5	+5
Single Compressor Unit Models															
HLR13-ZBD30KCE				4.1*	6.8	8.3	12.1	HLR13-ZBD30KCE				2.7*	3.0	3.1	3.4
HLR13-ZBD45KCE				6.0*	10.0	12.2	17.7	HLR13-ZBD45KCE				3.8*	4.2	4.4	4.8
Tandem Compressor Unit Models															
HLR31-ZBDT60KCE				8.2*	13.5	16.6	24.2	HLR31-ZBDT60KCE				5.4*	5.9	6.2	6.8
HLR31-ZBDT90KCE				11.9*	20.0	24.4	35.4	HLR31-ZBDT90KCE				7.6*	8.4	8.8	9.6
HLR31-ZBDT116KCE				13.7*	25.5	31.7	46.2	HLR31-ZBDT116KCE				11.9*	11.8	11.9	12.1
HLR31-ZBDT152KCE				19.7*	34.9	43.10	62.5	HLR31-ZBDT152KCE				15.8*	16.0	16.10	16.5

Conditions: EN13215: Suction Gas Return 20°C, Subcooling 0K

* Suction Superheat 10K

Preliminary Data

Condensing Temperature: 45°C															
R404A	Cooling Capacity (kW)							R404A	Power Input (kW)						
	Evaporating Temperature (°C)								Evaporating Temperature (°C)						
Model	-45	-35	-30	-20	-10	-5	+5	Model	-45	-35	-30	-20	-10	-5	+5
Single Compressor Unit Models															
HLR13-ZBD30KCE			2.7*	4.8	7.0	8.4	11.8	HLR13-ZBD30KCE			2.4*	2.9	3.1	3.2	3.5
HLR13-ZBD45KCE			3.4*	6.6	10.2	12.5	18.0	HLR13-ZBD45KCE			4.4*	4.6	4.8	4.9	5.2
HLR13-ZBD58KCE				8.6	13.5	16.3	22.9	HLR13-ZBD58KCE				6.4	6.4	6.4	6.4
HLR13-ZBD76KCE				11.8	17.9	21.4	30.2	HLR13-ZBD76KCE				8.1	8.3	8.3	8.4
Tandem Compressor Unit Models															
HLR31-ZBDT60KCE			5.4*	9.6	14.1	16.9	23.6	HLR31-ZBDT60KCE			4.9*	5.8	6.3	6.5	6.9
HLR31-ZBDT90KCE			7.0*	13.4	20.3	24.5	35.0	HLR31-ZBDT90KCE			9.2*	9.4	9.6	9.7	9.9
HLR31-ZBDT116KE			6.4*	17.0	26.7	32.4	45.8	HLR31-ZBDT116KE			13.1*	12.7	12.7	12.7	12.8
HLR31-ZBDT152KE				23.7	35.7	42.9	60.3	HLR31-ZBDT152KE				16.2	16.4	16.5	16.8

Conditions: EN12900: Condensing Temperature 45°C, Suction Gas Return 20°C, Subcooling 0K

* Conditions: EN12900: Condensing Temperature 45°C, Suction Superheat 10K

Condensing Temperature: 40°C															
R407C	Cooling Capacity (kW)							R407C	Power Input (kW)						
	Evaporating Temperature (°C)								Evaporating Temperature (°C)						
Model	-45	-35	-30	-20	-10	-5	+5	Model	-45	-35	-30	-20	-10	-5	+5
Single Compressor Unit Models															
HLR13-ZBD30KCE					6.2	7.6	11.1	HLR13-ZBD30KCE					3.0	3.0	3.0
HLR13-ZBD45KCE					8.9	11.1	16.5	HLR13-ZBD45KCE					4.1	4.1	4.2
Tandem Compressor Unit Models															
HLR31-ZBDT60KCE					12.2*	15.2	22.2	HLR31-ZBDT60KCE					6.0*	6.0	6.1
HLR31-ZBDT90KCE					17.5*	22.2	32.9	HLR31-ZBDT90KCE					8.3*	8.3	8.4

Conditions: EN13215: Suction Gas Return 20°C, Subcooling 0K

* Suction Superheat 10K

Capacity Data

Condensing Temperature: 40°C															
R134a	Cooling Capacity (kW)							R134a	Power Input (kW)						
	Evaporating Temperature (°C)								Evaporating Temperature (°C)						
Model	-45	-35	-30	-20	-10	-5	+5	Model	-45	-35	-30	-20	-10	-5	+5
Single Compressor Unit Models															
HLR13-ZBD30KCE					4.3	5.2	7.5	HLR13-ZBD30KCE					1.9	2.0	2.2
HLR13-ZBD45KCE					6.0	7.5	11.2	HLR13-ZBD45KCE					2.7	2.9	3.1
HLR13-ZBD58KCE					7.8	9.7	14.4	HLR13-ZBD58KCE					3.8	3.8	3.9
HLR31-ZBD76KCE					10.2	12.7	18.9	HLR31-ZBD76KCE					4.9	5.0	5.1
Tandem Compressor Unit Models															
HLR31-ZBDT60KCE					8.3	10.3	15.2	HLR31-ZBDT60KCE					3.9	4.0	4.2
HLR31-ZBDT90KCE					12.1	15.1	22.6	HLR31-ZBDT90KCE					5.5	5.6	5.9
HLR31-ZBDT116KCE					15.6	19.4	28.8	HLR31-ZBDT116KCE					7.5	7.6	7.8
HLR31-ZBDT152KCE					20.4	25.3	37.8	HLR31-ZBDT152KCE					9.8	9.9	10.2

Conditions: EN13215: Suction Gas Return 20°C, Subcooling 0K
Preliminary Data

Condensing Temperature: 40°C															
R450A	Cooling Capacity (kW)							R450A	Power Input (kW)						
	Evaporating Temperature (°C)								Evaporating Temperature (°C)						
Model	-45	-35	-30	-20	-10	-5	+5	Model	-45	-35	-30	-20	-10	-5	+5
Single Compressor Unit Models															
HLR13-ZBD30KCE				2.0*	3.6	4.6	6.9	HLR13-ZBD30KCE				1.5*	1.6	1.7	1.8
HLR13-ZBD45KCE				3.0*	5.4	6.7	10.2	HLR13-ZBD45KCE				2.2*	2.4	2.5	2.8
Tandem Compressor Unit Models															
HLR31-ZBDT60KCE				4.1*	7.3	9.1	13.8	HLR31-ZBDT60KCE				3.0*	3.2	3.3	3.6
HLR31-ZBDT90KCE				5.9*	10.8	13.5	20.3	HLR31-ZBDT90KCE				4.4*	4.7	4.9	5.3

Conditions: EN13215: Suction Gas Return 20°C, Subcooling 0K
Preliminary Data

Condensing Temperature: 40°C															
R513A	Cooling Capacity (kW)							R513A	Power Input (kW)						
	Evaporating Temperature (°C)								Evaporating Temperature (°C)						
Model	-45	-35	-30	-20	-10	-5	+5	Model	-45	-35	-30	-20	-10	-5	+5
Single Compressor Unit Models															
HLR13-ZBD30KCE				2.5*	4.3	5.4	8.0	HLR13-ZBD30KCE				1.8*	1.9	2.0	2.1
HLR13-ZBD45KCE				3.6*	6.4	7.9	11.9	HLR13-ZBD45KCE				2.6*	2.8	2.9	3.1
Tandem Compressor Unit Models															
HLR31-ZBDT60KCE				5.0*	8.7	10.8	16.0	HLR31-ZBDT60KCE				3.5*	3.9	4.0	4.2
HLR31-ZBDT90KCE				7.3*	12.8	15.9	23.7	HLR31-ZBDT90KCE				5.1*	5.6	5.8	6.3

Conditions: EN13215: Suction Gas Return 20°C, Subcooling 0K
Preliminary Data



Semi-Hermetic Refrigeration Units K/L Compressors

Copeland™ air-cooled indoor refrigeration units for medium temperature and low temperature applications.

Long-term engineering and manufacturing experience has led to these refrigeration units with reed valve technology compressors. Their excellent quality and reliability is traditionally well known in the refrigeration industry.

This series of refrigeration units is equipped with single fan or twin fans which allows for very compact dimensions. The wide range of models offers solutions for most applications including operation in extreme conditions like high evaporation temperatures and high ambient temperatures.



Semi-Hermetic Refrigeration Unit K/L
Compressors

Semi-Hermetic K & L Refrigeration Units Line-up

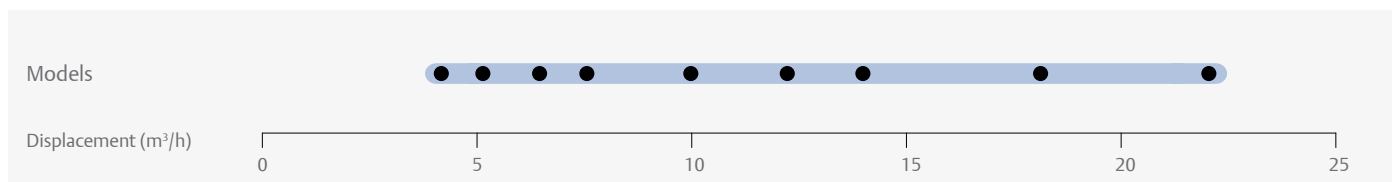

Features and Benefits

- Standard equipment: compressor, condenser with thermally protected fan(s), discharge line with flexible pipe loop or vibration absorber, liquid receiver with shut-off-valve, HP/LP switch with automatic reset
- Suitable for a broad range of refrigerants: R407A/F, R404A and R134a
- Wide range of quality accessories
- Proven reliability

Maximum Allowable Pressures (PS)

- Low Side PS 22.5 bar (g)
- High Side PS = 28 bar (g)

Technical Overview

Models	Displacement (m ³ /h)	Receiver Capacity (l)	Number of fans	Total Fan Motor Power (W)	Suction Line Diameter (inch)	Liquid Line Diameter (inch)	Width/Depth/Height (mm)	Net Weight (kg)	Motor Version/Code		Maximum Operating Current (A)		Locked Rotor Current (A)		Sound Pressure @10m - dB(A)***
									1 Ph*	3 Ph**	1 Ph*	3 Ph**	1 Ph*	3 Ph**	
B8-KJ-10X-B	3.3	3.3	1	85	5/8	1/2	560/570/396	57.5	CAG	EWL	7	3	32	16	39.0
B8-KJ-7X-B	3.3	3.3	1	85	5/8	1/2	560/570/396	57.5	CAG	EWL	6	2	35	12	
B8-KL-15X-B	3.3	3.3	1	85	5/8	1/2	560/570/396	57.5	CAG	EWL	8	3	43	19	39.5
B8-KM-5X-B	3.3	3.3	1	85	5/8	1/2	560/570/396	56.0	CAG	EWL	5	2	24	12	39.0
B8-KM-7X-B	3.3	3.3	1	85	1/2	1/2	560/570/396	57.5	CAG	EWL	6	2	35	12	
B8-KSJ-10X-B	3.3	3.3	1	85	5/8	1/2	560/570/396	58.5	CAG	EWL	7	3	32	16	
D8-KSJ-15X-B	3.9	3.9	1	110	7/8	1/2	560/570/446	62.0	CAG	EWL	9	3	43	19	45.6
D8-KSL-20X-B	3.9	3.9	1	110	5/8	1/2	560/570/446	60.0		EWL		5		23	
D8-LE-20X-B	3.9	3.9	1	110	5/8	1/2	560/715/446	96.5		EWL		6		38	
D8-LF-20X-B	3.9	3.9	1	110	5/8	1/2	560/715/446	98.5		EWL		6		38	
H8-KSL-20X-B	7.9	7.9	1	235	5/8	1/2	735/680/533	60.0		EWL		5		23	
H8-LE-20X-B	7.9	7.9	1	235	7/8	1/2	735/680/533	108.0		EWL		6		38	
H8-LF-30X-B	7.9	7.9	1	235	7/8	1/2	735/680/533	108.0		EWL		7		51	48.5
H8-LJ-20X-B	7.9	7.9	1	235	7/8	1/2	735/680/533	103.0		EWL		6		38	
H8-LJ-30X-B	7.9	7.9	1	235	7/8	1/2	735/680/533	108.0		EWL		7		51	48.5
H8-LL-30X-B	7.9	7.9	1	235	1 1/8	1/2	735/680/533	110.0		EWL		7		53	48.5
H8-LL-40X-B	7.9	7.9	1	235	1 1/8	1/2	735/680/533	112.0		EWL		10		59	48.6
H8-LSG-40X-B	7.9	7.9	1	235	1 1/8	1/2	735/680/533	116.0		EWL		9		69	
K9-LL-30X-B	7.9	7.9	2	220	1 1/8	1/2	950/640/454	134.0		EWL		7		53	47.2
K9-LSG-40X-B	7.9	7.9	2	220	1 1/8	1/2	950/640/454	131.0		EWL		9		69	50.9
P8-LF-30X-B	7.9	7.9	2	220	1 1/8	1/2	950/640/633	127.0		EWL		7		51	47.8
P8-LJ-30X-B	7.9	7.9	2	220	7/8	1/2	950/640/633	127.0		EWL		7		51	47.8
P8-LL-40X-B	7.9	7.9	2	220	1 1/8	1/2	950/640/633	128.0		EWL		10		59	48.0

* 1ph: 230V/ 50Hz

** 3 Ph: 380-420V/ 50Hz

*** @ 10m: sound pressure level at 10m distance from the compressor, free field condition

Capacity Data

Ambient Temperature: 32°C															
R407A	Cooling Capacity (kW)							R407A	Power Input (kW)						
	Evaporating Temperature (°C)								Evaporating Temperature (°C)						
Model	-45	-35	-30	-20	-10	-5	+5	Model	-45	-35	-30	-20	-10	-5	+5
B8-KM-5X-B		0.5	0.7	1.2				B8-KM-5X-B		0.5	0.6	0.7			
B8-KM-7X-B		0.5	0.7	1.2	1.8	2.2	3.0	B8-KM-7X-B		0.6	0.6	0.8	0.9	1.0	1.2
B8-KJ-7X-B		0.7	0.9	1.5				B8-KJ-7X-B		0.7	0.8	1.0			
B8-KJ-10X-B		0.7	0.9	1.5	2.3	2.7		B8-KJ-10X-B		0.6	0.7	0.9	1.2	1.4	
D8-KSJ-15X-B		0.9	1.2	2.0	3.0	3.6		D8-KSJ-15X-B		0.9	1.0	1.3	1.5	1.7	
B8-KSJ-10X-B		0.9	1.2	1.9				B8-KSJ-10X-B		0.9	1.0	1.3			
B8-KL-15X-B		1.0	1.3	2.1				B8-KL-15X-B		1.0	1.1	1.4			
D8-LE-20X-B		0.9	1.4	2.6	4.1	5.0		D8-LE-20X-B		0.9	1.1	1.5	2.0	2.2	
H8-LE-20X-B		0.9	1.5	2.8	4.6	5.6	7.9	H8-LE-20X-B		1.0	1.2	1.6	2.1	2.3	2.7
H8-LF-30X-B		1.3	2.0	3.7	5.9	7.1		H8-LF-30X-B		1.4	1.6	2.2	2.8	3.1	
P8-LF-30X-B		1.4	2.1	3.9	6.2	7.5	10.6	P8-LF-30X-B		1.3	1.6	2.2	2.7	3.0	3.6
D8-LF-20X-B		1.3	1.8	3.2				D8-LF-20X-B		1.2	1.5	2.0			
P8-LJ-30X-B		1.9	2.6	4.5	6.9	8.3		P8-LJ-30X-B		1.7	1.9	2.6	3.2	3.6	
H8-LJ-20X-B		1.6	2.3	4.2				H8-LJ-20X-B		1.5	1.8	2.5			
H8-LJ-30X-B		1.8	2.6	4.3	6.6	7.9		H8-LJ-30X-B		1.7	2.0	2.6	3.3	3.7	
H8-LL-40X-B		2.1	3.1	5.3	8.0	9.5		H8-LL-40X-B		1.9	2.2	3.1	4.1	4.6	
H8-LL-30X-B		2.1	3.0	5.2				H8-LL-30X-B		1.8	2.2	3.1			
P8-LL-40X-B		2.2	3.2	5.6	8.6	10.4		P8-LL-40X-B		1.9	2.2	3.1	4.0	4.5	
K9-LSG-40X-B		2.7	3.8	6.3				K9-LSG-40X-B		2.3	2.7	3.8			

Conditions: EN13215: Suction Gas Return 20°C, Subcooling 0K

Capacity Data

Ambient Temperature: 32°C															
R404A	Cooling Capacity (kW)							R404A	Power Input (kW)						
	Evaporating Temperature (°C)								Evaporating Temperature (°C)						
Model	-45	-35	-30	-20	-10	-5	+5	Model	-45	-35	-30	-20	-10	-5	+5
B8-KM-7X-B	0.3	0.6	0.8	1.3	1.9	2.2	3.0	B8-KM-7X-B	0.4	0.6	0.7	0.8	1.0	1.1	1.3
B8-KM-5X-B	0.3	0.6	0.8	1.3				B8-KM-5X-B	0.5	0.6	0.6	0.8			
B8-KJ-7X-B	0.4	0.8	1.1	1.7				B8-KJ-7X-B	0.6	0.8	0.9	1.1			
B8-KJ-10X-B	0.4	0.8	1.1	1.7	2.4	2.8	3.6	B8-KJ-10X-B	0.5	0.8	0.9	1.1	1.4	1.5	1.8
D8-KSJ-15X-B	0.6	1.1	1.4	2.2	3.2	3.8		D8-KSJ-15X-B	0.7	1.0	1.1	1.4	1.8	1.9	
B8-KSJ-10X-B	0.6	1.1	1.3					B8-KSJ-10X-B	0.8	1.0	1.2				
B8-KL-15X-B	0.7	1.2	1.5	2.3				B8-KL-15X-B	0.9	1.1	1.3	1.6			
H8-KSL-20X-B	0.9	1.7	2.2	3.3	4.8	5.7		H8-KSL-20X-B	1.1	1.5	1.7	2.1	2.6	2.8	
D8-KSL-20X-B	0.9	1.6	2.0	3.1	4.3			D8-KSL-20X-B	1.0	1.3	1.5	2.0	2.6		
H8-LE-20X-B		1.3	1.9	3.2	4.8	5.8	7.8	H8-LE-20X-B		1.2	1.4	1.9	2.3	2.5	3.0
D8-LE-20X-B		1.2	1.7	2.9	4.3	5.0		D8-LE-20X-B		1.1	1.3	1.7	2.2	2.5	
H8-LF-30X-B	0.9	2.1	2.7	4.4	6.3	7.4		H8-LF-30X-B	1.3	1.9	2.1	2.7	3.3	3.6	
P8-LF-30X-B	1.0	2.1	2.9	4.7	6.9	8.2	11.1	P8-LF-30X-B	1.3	1.9	2.1	2.6	3.2	3.4	4.0
D8-LF-20X-B		1.7	2.2	3.5				D8-LF-20X-B		1.5	1.8	2.4			
H8-LJ-20X-B		2.1	2.9					H8-LJ-20X-B		1.8	2.2				
P8-LJ-30X-B	1.1	2.4	3.2	5.1	7.5	8.9	11.9	P8-LJ-30X-B	1.4	2.0	2.3	3.0	3.6	4.0	4.6
H8-LJ-30X-B	1.1	2.3	3.0	4.7	6.8	7.9		H8-LJ-30X-B	1.4	2.0	2.4	3.0	3.8	4.2	
H8-LL-40X-B	1.4	2.8	3.6	5.7	8.1	9.4		H8-LL-40X-B	1.7	2.4	2.8	3.7	4.7	5.3	
H8-LL-30X-B	1.2	2.7	3.6	5.7				H8-LL-30X-B	1.5	2.2	2.7	3.6			
P8-LL-40X-B	1.4	2.9	3.9	6.2	9.1	10.8		P8-LL-40X-B	1.7	2.4	2.8	3.6	4.5	5.0	
K9-LL-30X-B	1.2	2.7	3.6	5.7				K9-LL-30X-B	1.5	2.2	2.6	3.6			
H8-LSG-40X-B	1.7	3.4	4.4	6.7				H8-LSG-40X-B	1.9	2.8	3.3	4.5			
K9-LSG-40X-B	1.7	3.4	4.4	6.7				K9-LSG-40X-B	1.9	2.8	3.3	4.5			

Conditions: EN13215: Suction Gas Return 20°C, Subcooling 0K

Ambient Temperature: 32°C															
R134a	Cooling Capacity (kW)							R134a	Power Input (kW)						
	Evaporating Temperature (°C)								Evaporating Temperature (°C)						
Model	-45	-35	-30	-20	-10	-5	+5	Model	-45	-35	-30	-20	-10	-5	+5
B8-KM-5X-B				0.8	1.2	1.5	2.2	B8-KM-5X-B				0.6	0.6	0.6	0.6
B8-KJ-7X-B				1.0	1.6	1.9	2.8	B8-KJ-7X-B				0.8	0.8	0.8	0.8
B8-KSJ-10X-B				1.2	1.9	2.4	3.4	B8-KSJ-10X-B				0.8	0.9	1.0	0.8
B8-KL-15X-B				1.4	2.2	2.6	3.7	B8-KL-15X-B				0.9	1.2	1.3	1.2
D8-KSL-20X-B				1.8	2.9	3.5	5.0	D8-KSL-20X-B				1.1	1.4	1.5	1.8
H8-KSL-20X-B				1.9	3.0	3.7	5.4	H8-KSL-20X-B				1.2	1.5	1.6	1.8
D8-LE-20X-B				1.6	2.7	3.4	4.9	D8-LE-20X-B				1.4	1.4	1.4	1.4
H8-LE-20X-B				1.7	2.9	3.6	5.4	H8-LE-20X-B				1.5	1.5	1.5	1.5
D8-LF-20X-B				2.2	3.6	4.4	6.2	D8-LF-20X-B				1.7	1.7	1.7	1.7
H8-LJ-20X-B				2.7	4.3	5.2	7.5	H8-LJ-20X-B				2.2	2.2	2.2	2.2
H8-LL-30X-B				3.2	5.2	6.4	9.2	H8-LL-30X-B				2.1	2.1	2.1	2.1
K9-LL-30X-B				3.2	5.3	6.5	9.3	K9-LL-30X-B				2.1	2.6	2.1	2.1
H8-LSG-40X-B				4.2	6.5	7.9	11.0	H8-LSG-40X-B				3.2	3.2	3.2	3.2
K9-LSG-40X-B				4.2	6.6	8.0	11.1	K9-LSG-40X-B				2.5	3.2	3.6	3.6

Conditions: EN13215: Suction Gas Return 20°C, Subcooling 0K

Refrigeration Units With Semi-Hermetic Discus™ Compressors

Copeland™ air-cooled indoor refrigeration units for medium temperature and low temperature applications.

In a further approach to improve compressor performance and reduce compression losses, Emerson engineers developed the Discus valve technology.

This series of refrigeration units is equipped with 2 or 3 cylinder semi-hermetic compressors with Discus valve technology. The models are specifically suitable for those applications where high efficiency and low energy consumption is required.

The wide range of compressor models combined with 2 or 4 fan high capacity condensers covers most application needs of low temperature and medium temperature applications.



Refrigeration Units with Semi-Hermetic Discus Compressors

Discus Refrigeration Units Line-up

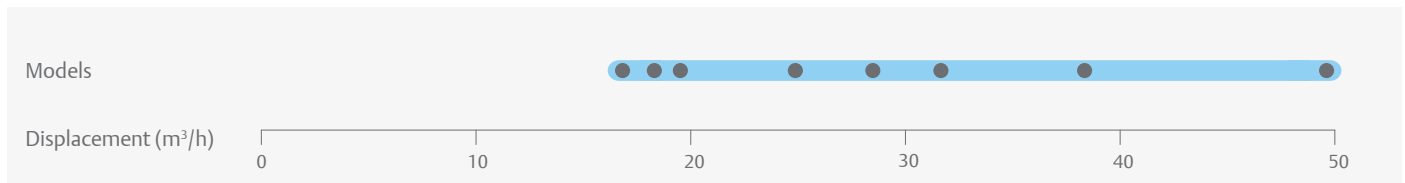

Features and Benefits

- Standard equipment: Discus compressor, condenser with thermally protected fan(s), discharge line with flexible pipe loop or vibration absorber, liquid receiver with shut-off-valve, HP/LP switch with automatic reset, oil pressure safety control OPS2
- Suitable for multiple refrigerants: R407A/F, R448A/R449A, R404A, R134a, R450A and R513A
- Wide range of quality accessories
- Excellent efficiency
- Proven reliability

Maximum Allowable Pressures (PS)

- Low Side PS 22.5 bar (g)
- High Side PS = 28 bar (g)

Technical Overview

Model	Displacement (m ³ /h)	Receiver Capacity (l)	Number of fans	Total Fan Motor Power (W)	Suction Line Diameter (inch)	Liquid Line Diameter (inch)	Width/Depth/Height (mm)	Net Weight (kg)	Motor Version/Code	Maximum Operating Current (A)	Locked Rotor Current (A)	Sound Pressure @10m - dB(A)***
									3 Ph**	3 Ph**	3 Ph**	
P8-2DC-50X-B	17	11.7	2	220	1 3/8	5/8	950/740/633	186.0	AWM	9	55	
R7-2DD-50X-B	19	15.8	2	470	1 3/8	3/4	1130/820/633	196.0	AWM	10	55	
P8-2DL-75X-B	24	11.7	2	220	1 3/8	5/8	950/740/633		AWM	14	82	50.0
R7-2DL-75X-B	24	15.8	2	470	1 3/8	3/4	1130/820/708	205.0	AWM	14	82	
P8-2DB-50X-B	28	11.7	2	220	1 3/8	5/8	950/740/633	186.0	AWM	13	55	49.6
P8-2DB-75X-B	28	11.7	2	220	1 3/8	5/8	950/740/633	191.0	AWM	16	82	52.0
S9-2DB-75X-B	28	15.8	2	470	1 3/8	3/4	1130/820/708	212.0	AWM	16	82	
P8-3DA-50X-B	32	11.7	2	220	1 3/8	5/8	950/740/633	205.0	AWM	16	55	51.6
P8-3DA-75X-B	32	11.7	2	220	1 3/8	5/8	950/740/633	211.0	AWM	18	106	52.0
S9-3DA-75X-B	32	18.9	2	470	1 3/8	7/8	1330/820/835	259.0	AWM	18	106	
R7-3DC-100X-B	38	15.8	2	470	1 3/8	3/4	1129/820/633	234.0	AWM	21	121	56.0
R7-3DC-75X-B	38	15.8	2	470	1 3/8	3/4	1130/820/633	278.0	AWM	18	82	54.6
S9-3DS-100X-B	50	15.8	2	470	1 3/8	3/4	1130/820/708	239.0	AWM	24	121	54.0
S9-3DS-150X-B	50	15.8	2	470	1 3/8	3/4	1129/820/708	243.0	AWM	29	123	57.0

** 3 Ph: 380-420V/ 50Hz

*** @ 10m: sound pressure level at 10m distance from the compressor, free field condition

Capacity Data

Ambient Temperature: 32°C															
R407A	Cooling Capacity (kW)							R407A	Power Input (kW)						
	Evaporating Temperature (°C)								Evaporating Temperature (°C)						
Model	-45	-35	-30	-20	-10	-5	+5	Model	-45	-35	-30	-20	-10	-5	+5
P8-2DC-50X-B		1.8	2.6	4.5	7.1	8.7	12.3	P8-2DC-50X-B		1.6	1.9	2.5	3.2	3.6	4.5
R7-2DD-50X-B		2.4	3.4	5.8	9.1	11.0	15.5	R7-2DD-50X-B		2.2	2.5	3.2	4.0	4.4	5.2
R7-2DL-75X-B				7.1	10.9	13.1	18.2	R7-2DL-75X-B				4.0	5.0	5.5	6.6
P8-2DB-75X-B				7.9	11.4	13.2		P8-2DB-75X-B				4.8	6.3	7.1	
S9-2DB-75X-B				8.7	13.2	15.7	21.4	S9-2DB-75X-B				4.9	6.1	6.8	8.1
P8-2DB-50X-B		3.3*	4.5*	7.9	11.3	13.2		P8-2DB-50X-B		3.0*	3.5*	4.7	6.2	7.1	
S9-3DA-75X-B				9.8	14.7	17.5	23.7	S9-3DA-75X-B				5.6	7.0	7.8	9.4
P8-3DA-50X-B		3.7*	5.0*	8.7	12.1	13.9		P8-3DA-50X-B		3.4*	4.1*	5.6	7.4	8.5	
P8-3DA-75X-B				8.5	12.2	14.2		P8-3DA-75X-B				5.5	7.2	8.2	
R7-3DC-75X-B		4.7*	6.3*	11.1	15.8	18.3		R7-3DC-75X-B		4.3*	5.1*	6.8	8.8	9.9	
V6-3DC-100X-B				12.6	19.1	22.9	31.5	V6-3DC-100X-B				6.6	8.2	9.0	10.6
R7-3DC-100X-B				11.1	16.2	18.9		R7-3DC-100X-B				6.5	8.5	9.6	
V6-3DS-150X-B				16.1	23.8	28.2	37.8	V6-3DS-150X-B				8.9	11.2	12.4	15.0
S9-3DS-100X-B		6.3*	8.5*	14.7	20.5	23.6		S9-3DS-100X-B		5.7*	6.7*	9.0	11.8	13.4	
W9-3DS-150X-B				16.3	24.2	28.7	38.8	W9-3DS-150X-B				8.8	11.1	12.3	14.7

Conditions: EN13215: Suction Gas Return 20°C, Subcooling 0K

* Conditions: EN13215: Suction Superheat 10K

Ambient Temperature: 32°C															
R448A	Cooling Capacity (kW)							R448A	Power Input (kW)						
	Evaporating Temperature (°C)								Evaporating Temperature (°C)						
Model	-45	-35	-30	-20	-10	-5	+5	Model	-45	-35	-30	-20	-10	-5	+5
P8-2DC-50X		1.7*	2.8	4.9	7.6	9.1	12.6	P8-2DC-50X		1.6*	2.0	2.7	3.4	3.8	4.6
R7-2DD-50X		2.0*	3.3	5.9	9.2	11.1	15.6	R7-2DD-50X		2.1*	2.5	3.3	4.1	4.5	5.3
P8-2DL-75X		2.6*	3.7*	6.7	10.1	12.0		P8-2DL-75X		2.5*	2.9*	3.8	4.9	5.6	
R7-2DL-75X		2.8*	4.2	7.1	11.0	13.4	18.8	R7-2DL-75X		2.8*	3.1	4.0	5.0	5.5	6.8
P8-2DB-50X		3.6*	4.8*	8.0	11.4	13.3		P8-2DB-50X		3.1*	3.6*	4.8	6.4	7.2	
P8-2DB-75X		3.7*	5.0*	8.2	11.7	13.5		P8-2DB-75X		3.2*	3.7*	5.0	6.4	7.3	
S9-2DB-75X		4.0*	5.4*	9.2	13.6	16.3	22.1	S9-2DB-75X		3.4*	3.9*	5.0	6.2	6.8	8.3
P8-3DA-50X		4.0*	5.2*	8.6	12.2			P8-3DA-50X		3.5*	4.1*	5.6	7.4		
P8-3DA-75X		3.8*	5.3*	9.0	13.0	15.1		P8-3DA-75X		3.6*	4.2*	5.7	7.4	8.3	
S9-3DA-75X		4.2*	5.9*	10.4	15.5	18.4	25.1	S9-3DA-75X		3.8*	4.4*	5.8	7.1	7.9	9.4
R7-3DC-100X		4.6*	6.6*	11.5	16.5	19.2		R7-3DC-100X		4.1*	4.8*	6.6	8.5	9.6	
V6-3DC-100X		5.2*	7.8	13.1	19.7	23.4	32.0	V6-3DC-100X		4.4*	5.2	6.7	8.2	9.1	10.8
R7-3DC-75X		5.1*	6.7*	11.0	15.8	18.4		R7-3DC-75X		4.5*	5.1*	6.8	8.7	9.8	
S9-3DS-100X		7.0*	9.0*	14.8	21.2			S9-3DS-100X		5.8*	6.8*	9.1	11.9		
S9-3DS-150X		7.3*	9.5*	15.3	21.2	24.3		S9-3DS-150X		6.1*	7.0*	9.3	11.9	13.3	
V6-3DS-150X		7.8*	10.3*	16.9	24.5	28.8	38.2	V6-3DS-150X		6.3*	7.2*	9.2	11.4	12.6	15.2
W9-3DS-150X		7.8*	10.4*	17.2	24.9	29.4	39.2	W9-3DS-150X		6.3*	7.2*	9.1	11.3	12.5	15.0

Conditions: EN13215: Suction Gas Return 20°C, Subcooling 0K

* Conditions: EN13215: Suction Superheat 10K

Preliminary Data

Capacity Data

Ambient Temperature: 32°C															
R449A	Cooling Capacity (kW)							R449A	Power Input (kW)						
	Evaporating Temperature (°C)								Evaporating Temperature (°C)						
Model	-45	-35	-30	-20	-10	-5	+5	Model	-45	-35	-30	-20	-10	-5	+5
P8-2DC-50X		1.7*	2.8	4.9	7.6	9.1	12.6	P8-2DC-50X		1.6*	2.0	2.7	3.4	3.8	4.6
R7-2DD-50X		2.0*	3.3	5.9	9.2	11.1	15.6	R7-2DD-50X		2.1*	2.5	3.3	4.1	4.5	5.3
P8-2DL-75X		2.6*	3.7*	6.7	10.1	12.0		P8-2DL-75X		2.5*	2.9*	3.8	4.9	5.6	
R7-2DL-75X		2.8*	4.2	7.1	11.0	13.4	18.8	R7-2DL-75X		2.8*	3.1	4.0	5.0	5.5	6.8
P8-2DB-50X		3.6*	4.8*	8.0	11.4	13.3		P8-2DB-50X		3.1*	3.6*	4.8	6.4	7.2	
P8-2DB-75X		3.7*	4.9*	8.2	11.7	13.5		P8-2DB-75X		3.2*	3.7*	5.0	6.4	7.3	
S9-2DB-75X		4.0*	5.4*	9.2	13.6	16.3	22.1	S9-2DB-75X		3.4*	3.9*	5.0	6.2	6.8	8.3
P8-3DA-50X		4.0*	5.2*	8.6	12.2			P8-3DA-50X		3.5*	4.1*	5.6	7.4		
P8-3DA-75X		3.8*	5.2*	9.0	13.0	15.1		P8-3DA-75X		3.6*	4.2*	5.7	7.4	8.3	
S9-3DA-75X		4.2*	5.9*	10.4	15.5	18.4	25.1	S9-3DA-75X		3.8*	4.4*	5.8	7.1	7.9	9.4
R7-3DC-100X		4.6*	6.6*	11.5	16.5	19.2		R7-3DC-100X		4.1*	4.8*	6.6	8.5	9.6	
V6-3DC-100X		5.2*	7.8	13.1	19.7	23.4	32.0	V6-3DC-100X		4.4*	5.2	6.7	8.2	9.1	10.8
R7-3DC-75X		5.1*	6.6*	11.0	15.8	18.4		R7-3DC-75X		4.5*	5.1*	6.8	8.7	9.8	
S9-3DS-100X		6.9*	9.0*	14.8	21.2			S9-3DS-100X		5.8*	6.8*	9.1	11.9		
S9-3DS-150X		7.3*	9.5*	15.3	21.2	24.3		S9-3DS-150X		6.1*	7.0*	9.3	11.9	13.3	
V6-3DS-150X		7.8*	10.3*	16.9	24.5	28.8	38.2	V6-3DS-150X		6.3*	7.2*	9.2	11.4	12.6	15.2
W9-3DS-150X		7.8*	10.4*	17.2	24.9	29.4	39.2	W9-3DS-150X		6.3*	7.2*	9.1	11.3	12.5	15.0

Conditions: EN13215: Suction Gas Return 20°C, Subcooling 0K

* Conditions: EN13215: Suction Superheat 10K

Preliminary Data

Ambient Temperature: 32°C															
R404A	Cooling Capacity (kW)							R404A	Power Input (kW)						
	Evaporating Temperature (°C)								Evaporating Temperature (°C)						
Model	-45	-35	-30	-20	-10	-5	+5	Model	-45	-35	-30	-20	-10	-5	+5
P8-2DC-50X-B		2.4	3.2	5.2	7.9	9.5	13.0	P8-2DC-50X-B		2.0	2.3	3.0	3.7	4.0	4.7
R7-2DD-50X-B		3.1	4.1	6.7	9.9	11.7	15.9	R7-2DD-50X-B		2.6	3.0	3.8	4.5	4.9	5.6
R7-2DL-75X-B		3.8	5.0	8.0	11.8	13.9	18.6	R7-2DL-75X-B		3.2	3.6	4.5	5.6	6.1	7.3
P8-2DB-75X-B		4.8	6.0	8.9	12.2	14.0		P8-2DB-75X-B		3.7	4.2	5.5	6.9	7.7	
S9-2DB-75X-B		5.1	6.5	10.0	14.2	16.7	21.9	S9-2DB-75X-B		3.9	4.4	5.6	6.9	7.6	8.9
P8-2DB-50X-B	2.0*	4.6	5.9	8.9	12.3			P8-2DB-50X-B	2.5*	3.4	4.0	5.4	7.0		
P8-3DA-50X-B	2.3*	5.4	6.7	9.6	12.9			P8-3DA-50X-B	2.9*	4.2	5.0	6.5	8.3		
P8-3DA-75X-B		5.0	6.5	9.8	13.5	15.4		P8-3DA-75X-B		4.1	4.8	6.4	8.1	9.0	
S9-3DA-75X-B		5.4	7.1	11.2	16.0	18.7	24.5	S9-3DA-75X-B		4.4	5.1	6.5	8.0	8.7	10.3
R7-3DC-75X-B	3.1*	6.7	8.4	12.1	16.2			R7-3DC-75X-B	3.9*	5.4	6.2	7.9	9.9		
R7-3DC-100X-B		6.3	8.2	12.3	16.6	18.9		R7-3DC-100X-B		5.1	5.9	7.8	9.8	10.8	
V6-3DC-100X-B		7.1	9.3	14.6	20.9	24.5	32.5	V6-3DC-100X-B		5.4	6.2	7.8	9.3	10.1	11.5
S9-3DS-100X-B	4.2*	9.0	11.3	16.2	21.5			S9-3DS-100X-B	5.1*	7.1	8.2	10.7	13.5		
V6-3DS-150X-B		9.4	12.2	18.5	25.9	30.1	39.1	V6-3DS-150X-B		7.1	8.2	10.6	12.9	14.1	16.3
W9-3DS-150X-B		9.4	12.2	18.7	26.2	30.5	39.7	W9-3DS-150X-B		7.1	8.2	10.5	12.9	14.0	16.2

Conditions: EN13215: Suction Gas Return 20°C, Subcooling 0K

* Conditions: EN13215: Suction Superheat 10K

Capacity Data

Ambient Temperature: 32°C															
R134a	Cooling Capacity (kW)							R134a	Power Input (kW)						
	Evaporating Temperature (°C)								Evaporating Temperature (°C)						
Model	-45	-35	-30	-20	-10	-5	+5	Model	-45	-35	-30	-20	-10	-5	+5
B8-KM-5X-B				0.8	1.2	1.5	2.2	B8-KM-5X-B				0.6	0.6	0.6	0.6
B8-KJ-7X-B				1.0	1.6	1.9	2.8	B8-KJ-7X-B				0.8	0.8	0.8	0.8
B8-KSJ-10X-B				1.2	1.9	2.4	3.4	B8-KSJ-10X-B				0.8	0.9	1.0	0.8
B8-KL-15X-B				1.4	2.2	2.6	3.7	B8-KL-15X-B				0.9	1.2	1.3	1.2
D8-KSL-20X-B				1.8	2.9	3.5	5.0	D8-KSL-20X-B				1.1	1.4	1.5	1.8
H8-KSL-20X-B				1.9	3.0	3.7	5.4	H8-KSL-20X-B				1.2	1.5	1.6	1.8
D8-LE-20X-B				1.6	2.7	3.4	4.9	D8-LE-20X-B				1.4	1.4	1.4	1.4
H8-LE-20X-B				1.7	2.9	3.6	5.4	H8-LE-20X-B				1.5	1.5	1.5	1.5
D8-LF-20X-B				2.2	3.6	4.4	6.2	D8-LF-20X-B				1.7	1.7	1.7	1.7
H8-LJ-20X-B				2.7	4.3	5.2	7.5	H8-LJ-20X-B				2.2	2.2	2.2	2.2
H8-LL-30X-B				3.2	5.2	6.4	9.2	H8-LL-30X-B				2.1	2.1	2.1	2.1
K9-LL-30X-B				3.2	5.3	6.5	9.3	K9-LL-30X-B				2.1	2.6	2.1	2.1
H8-LSG-40X-B				4.2	6.5	7.9	11.0	H8-LSG-40X-B				3.2	3.2	3.2	3.2
K9-LSG-40X-B				4.2	6.6	8.0	11.1	K9-LSG-40X-B				2.5	3.2	3.6	3.6

Conditions: EN13215: Suction Gas Return 20°C, Subcooling 0K

Refer to Emerson's Select software for R450A and R513A capacity data.



Refrigeration Units With Semi-Hermetic Stream Compressors and CoreSense™ Diagnostics

Copeland air-cooled indoor refrigeration units for low, medium and high temperature applications.

This series of refrigeration units is equipped with 4 or 6 cylinder high performance semi-hermetic Stream compressors. The advanced protection and diagnostic features reduce service costs and system downtime. These models are specifically suitable for those applications where high efficiency and reliability is required to achieve low lifecycle costs.

Multiple refrigerant approvals and wide range of accessories improve flexibility in system design.



Refrigeration Units with Semi-Hermetic Stream Compressors and CoreSense™ Diagnostics

Refrigeration Units With Stream Compressor Line-up

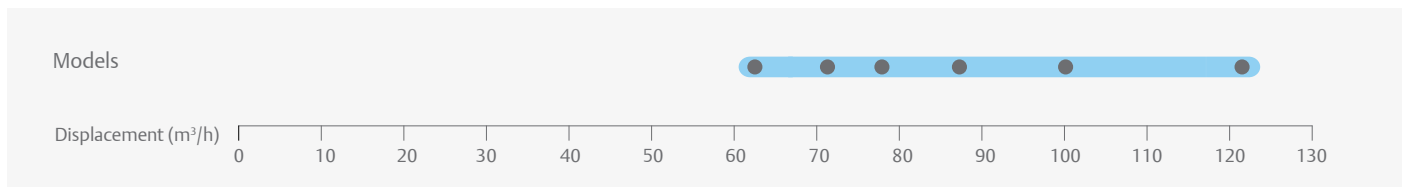

Features and Benefits

- Standard equipment: Stream compressor with CoreSense Diagnostics, condenser with thermally protected fan(s), discharge line with flexible pipe loop or vibration absorber, liquid receiver with shut-off-valve, HP/LP switch with automatic reset.
- Suitable for multiple refrigerants: R407A/F, R448A/R449A, R404A, R134a, R450A and R513A
- Wide range of quality accessories
- Excellent efficiency
- Proven reliability

Maximum Allowable Pressures (PS)

- Low pressure side = 22.5 bar
- High pressure side = 28 bar

CoreSense Diagnostics Features

- Motor and oil protection
- Storage of compressor asset and advanced runtime information
- Runtime and alarm signalling using multicoloured LED flash-codes
- System communication via Modbus
- Compressor power sensing

Technical Overview

Model	Displacement (m ³ /h)	Receiver Capacity (l)	Number of Fans	Total Fan Motor Power (W)	Suction Line Diameter (inch)	Liquid Line Diameter (inch)	Net Weight (kg)	Motor Version/ Code	Maximum Operating Current (A)	Locked Rotor Current (A)	Sound Pressure @10m - dB(A)***
								3 Ph**	3 Ph**	3 Ph**	
W99-6MI-40X	121	47.9	4	1600	2 1/8	7/8	521.0	AWM	71	304	59.0
Z9-4MA-22X	62	18.9	4	1600	1 5/8	7/8	383.0	AWM	36	175	59.0
V6-4ML-15X	71	18.9	2	800	1 5/8	7/8	303.0	AWM	35	156	57.0
V6-4MF-13X	62	18.9	2	800	1 5/8	7/8	295.0	AWM	31	105	57.0
Z9-4MH-25X	71	18.9	4	1600	2 1/8	7/8	389.0	AWM	42	199	59.0
Z9-4MM-20X	71	18.9	4	1600	2 1/8	7/8	388.0	AWM	39	175	
Z9-4MI-30X	78	18.9	4	1600	2 1/8	7/8	416.0	AWM	47	221	59.0
Z9-4MT-22X	71	18.9	4	1600	2 1/8	7/8	389.0	AWM	45	175	
Z9-4MJ-33X	88	18.9	4	1600	2 1/8	7/8	416.0	AWM	53	221	59.0
W9-4MT-22X	88	18.9	2	800	2 1/8	7/8	358.0	AWM	45	175	59.0
W9-4MM-20X	78	18.9	2	800	2 1/8	7/8	358.0	AWM	39	175	57.0
Z9-4MU-25X	100	18.9	4	1600	2 1/8	7/8	392.0	AWM	52	199	59.0
Z9-6MM-30X	121	18.9	4	1600	2 1/8	7/8	410.0	AWM	60	255	59.0
W99-4MK-35X	121	47.9	4	1600	2 1/8	7/8	504.0	AWM	61	255	59.0
Z9-4ML-15X	71	18.9	4	1600	1 5/8	7/8	386.0	AWM	35	156	

** 3 Ph: 380-420V/ 50Hz

*** @ 10m: sound pressure level at 10m distance from the compressor, free field condition

Capacity Data

R407A	Cooling Capacity (kW)							R407A	Power Input (kW)						
	Ambient Temperature: 32°C								Ambient Temperature: 32°C						
	Evaporating Temperature (°C)								Evaporating Temperature (°C)						
Model	-45	-35	-30	-20	-10	-5	+5	Model	-45	-35	-30	-20	-10	-5	+5
V6-4MF-13X		7.5*	10.3*	18.4	26.5	31.0		V6-4MF-13X		6.9*	8.1*	10.9	14.0	15.8	
Z9-4MA-22X				20.9	32.0	38.7	54.5	Z9-4MA-22X				11.0	13.3	14.5	17.0
Z9-4ML-15X		10.2*	15.2	24.6	36.7	43.8		Z9-4ML-15X		8.9*	10.2	12.9	15.8	17.4	
Z9-4MH-25X				24.4	36.6	43.9	60.9	Z9-4MH-25X				12.9	15.7	17.1	20.0
V6-4ML-15X		9.3*	12.6*	21.7	30.9	35.9		V6-4ML-15X		8.2*	9.6*	12.9	16.7	18.9	
Z9-4MI-30X				26.6	40.0	47.9	66.1	Z9-4MI-30X				14.2	17.4	19.0	22.5
Z9-4MM-20X		11.4*	16.7	26.7	39.6	47.2		Z9-4MM-20X		9.7*	11.2	14.3	17.6	19.3	
W9-4MM-20X		10.5*	14.0*	23.8	33.8	39.2		W9-4MM-20X		9.0*	10.6*	14.3	18.5	20.9	
Z9-4MJ-33X				29.3	43.6	52.0	71.2	Z9-4MJ-33X				15.9	19.6	21.5	25.8
W9-4MT-22X		11.1*	14.7*	25.1	35.2	40.6		W9-4MT-22X		10.3*	12.1*	16.4	21.4	24.3	
Z9-4MT-22X		12.1*	17.9	28.4	41.9	49.8		Z9-4MT-22X		10.9*	12.6	16.2	20.1	22.2	
W99-4MK-35X				32.4	47.9	56.8	76.6	W99-4MK-35X				18.1	22.6	25.0	30.4
Z9-4MU-25X		13.2*	19.8	31.7	46.5	55.0		Z9-4MU-25X		12.1*	14.0	18.1	22.8	25.5	
Z9-6MM-30X		15.8*	23.7	37.5	54.5	64.0		Z9-6MM-30X		14.2*	16.5	21.7	27.6	30.9	
W99-6MI-40X				38.4	56.2	66.1	87.7	W99-6MI-40X				21.6	27.3	30.5	37.5

Conditions: EN13215: Suction Gas Return 20°C, Subcooling 0K

* Conditions: EN13215: Suction Superheat 10K

R407F	Cooling Capacity (kW)							R407F	Power Input (kW)						
	Ambient Temperature: 32°C								Ambient Temperature: 32°C						
	Evaporating Temperature (°C)								Evaporating Temperature (°C)						
Model	-45	-35	-30	-20	-10	-5	+5	Model	-45	-35	-30	-20	-10	-5	+5
Z9-4MA-22X				21.3*	34.0	41.1	57.5	Z9-4MA-22X				11.7*	14.2	15.5	18.0
V6-4MF-13X		8.0*	11.0*	18.1*	27.5	32.1		V6-4MF-13X		7.2*	8.5*	11.4*	14.9	16.8	
V6-4ML-15X		9.9*	13.3*	21.4*	32.4			V6-4ML-15X		8.6*	10.1*	13.6*	17.9		
Z9-4MH-25X				24.4*	38.7	46.5	64.6	Z9-4MH-25X				13.5*	16.6	18.1	21.3
Z9-4MI-30X				26.9*	42.0	50.2	68.8	Z9-4MI-30X				14.7*	18.2	20.0	23.9
W9-4MM-20X		10.9*	14.6*	23.3*	35.1			W9-4MM-20X		9.6*	11.2*	15.0*	19.6		
Z9-4MJ-33X				29.6*	45.9	54.5	74.1	Z9-4MJ-33X				16.6*	20.6	22.9	27.7
W9-4MT-22X		12.4*	16.4*	25.5*	36.1*			W9-4MT-22X		10.9*	12.7*	17.2*	22.8*		
Z9-4MU-25X		14.8*	19.8*	32.2*	49.5	58.5		Z9-4MU-25X		12.7*	14.7*	19.1*	24.4	27.3	
W99-4MK-35X				32.5*	50.1	59.3	79.8	W99-4MK-35X				18.8*	23.6	26.4	32.7
W99-6MI-40X				38.4*	59.0	69.3	91.6	W99-6MI-40X				22.6*	28.9	32.4	40.2
Z9-6MM-30X		17.7*	23.7*	38.1*	58.0	68.1		Z9-6MM-30X		15.1*	17.4*	22.8*	29.3	32.8	

Conditions: EN13215: Suction Gas Return 20°C, Subcooling 0K

* Conditions: EN13215: Suction Superheat 10K

Capacity Data

R448A	Cooling Capacity (kW)							R448A	Power Input (kW)						
	Ambient Temperature: 32°C								Ambient Temperature: 32°C						
	Evaporating Temperature (°C)								Evaporating Temperature (°C)						
Model	-45	-35	-30	-20	-10	-5	+5	Model	-45	-35	-30	-20	-10	-5	+5
Z9-4MA-22X		9.0*	13.1	21.8	33.6	40.8	57.8	Z9-4MA-22X		7.8*	9.0	11.3	13.6	14.8	17.2
V6-4MF-13X		8.4*	11.0*	18.2	25.8	30.1		V6-4MF-13X		7.0*	8.2*	11.1	14.4	16.3	
Z9-4MH-25X		10.6*	15.2	24.9	37.5	45.0	62.2	Z9-4MH-25X		9.1*	10.4	13.2	16.1	17.7	20.9
V6-4ML-15X		10.5*	13.8*	22.4	31.6	36.6		V6-4ML-15X		8.4*	9.8*	13.2	17.3	19.7	
Z9-4ML-15X		11.5*	16.0	25.3	37.3	44.3		Z9-4ML-15X		9.1*	10.4	13.2	16.3	17.9	
Z9-4MI-30X		11.9*	17.2	27.9	41.7	49.7	68.2	Z9-4MI-30X		9.8*	11.4	14.6	17.9	19.7	23.2
W9-4MM-20X		11.7*	15.3*	24.5	34.1	39.2		W9-4MM-20X		9.3*	10.9*	14.6	19.3	22.0	
Z9-4MM-20X		12.7*	17.6	27.7	40.3	47.5		Z9-4MM-20X		10.0*	11.4	14.5	18.0	20.0	
Z9-4MJ-33X		13.2*	18.8	30.3	45.0	53.6	73.3	Z9-4MJ-33X		10.8*	12.5	16.2	20.2	22.3	26.8
W9-4MT-22X		13.1*	16.9*	27.0	37.2			W9-4MT-22X		10.5*	12.4*	16.7	22.1		
Z9-4MT-22X		14.4*	18.8*	30.7	44.5	52.4		Z9-4MT-22X		11.2*	12.8*	16.4	20.5	22.8	
W99-4MK-35X		14.7*	19.8*	33.4	49.3	58.5	79.3	W99-4MK-35X		12.3*	14.2*	18.6	23.3	25.9	31.3
Z9-4MU-25X		15.2*	20.0*	33.1	48.3	57.1		Z9-4MU-25X		12.3*	14.2*	18.5	23.6	26.5	
W99-6MI-40X		17.8*	23.9*	40.0	57.7	67.5	88.5	W99-6MI-40X		14.5*	16.9*	21.9	27.7	30.9	37.9
Z9-6MM-30X		18.3*	24.0*	39.1	55.5	64.6		Z9-6MM-30X		14.6*	16.9*	22.2	28.1	31.4	

Conditions: EN13215: Suction Gas Return 20°C, Subcooling 0K

* Conditions: EN13215: Suction Superheat 10K

Preliminary Data

R449A	Cooling Capacity (kW)							R449A	Power Input (kW)						
	Ambient Temperature: 32°C								Ambient Temperature: 32°C						
	Evaporating Temperature (°C)								Evaporating Temperature (°C)						
Model	-45	-35	-30	-20	-10	-5	+5	Model	-45	-35	-30	-20	-10	-5	+5
Z9-4MA-22X		9.0*	13.1	21.8	33.6	40.8	57.8	Z9-4MA-22X		7.8*	9.0	11.3	13.6	14.8	17.2
V6-4MF-13X		8.4*	11.0*	18.2	25.8	30.1		V6-4MF-13X		7.0*	8.2*	11.1	14.4	16.3	
Z9-4MH-25X		10.5*	15.2	24.9	37.5	45.0	62.2	Z9-4MH-25X		9.1*	10.4	13.2	16.1	17.7	20.9
V6-4ML-15X		10.4*	13.7*	22.4	31.6	36.6		V6-4ML-15X		8.4*	9.8*	13.2	17.3	19.7	
Z9-4ML-15X		11.4*	16.0	25.3	37.3	44.3		Z9-4ML-15X		9.1*	10.4	13.2	16.3	17.9	
W9-4MM-20X		11.7*	15.2*	24.5	34.1	39.2		W9-4MM-20X		9.3*	10.9*	14.6	19.3	22.0	
Z9-4MJ-33X		13.2*	18.8	30.3	45.0	53.6	73.3	Z9-4MJ-33X		10.8*	12.5	16.2	20.2	22.3	26.8
W9-4MT-22X		13.1*	16.9*	27.0	37.2			W9-4MT-22X		10.5*	12.4*	16.7	22.1		
Z9-4MT-22X		14.3*	18.8*	30.7	44.5	52.4		Z9-4MT-22X		11.2*	12.8*	16.4	20.5	22.8	
W99-4MK-35X		14.7*	19.7*	33.4	49.3	58.5	79.3	W99-4MK-35X		12.3*	14.2*	18.6	23.3	25.9	31.3
Z9-4MU-25X		15.1*	19.9*	33.1	48.3	57.1		Z9-4MU-25X		12.3*	14.2*	18.5	23.6	26.5	
W99-6MI-40X		17.7*	23.8*	40.0	57.7	67.5	88.5	W99-6MI-40X		14.5*	16.9*	21.9	27.7	30.9	37.9
Z9-6MM-30X		18.2*	24.0*	39.1	55.5	64.6		Z9-6MM-30X		14.6*	16.9*	22.2	28.1	31.4	

Conditions: EN13215: Suction Gas Return 20°C, Subcooling 0K

* Conditions: EN13215: Suction Superheat 10K

Preliminary Data

Capacity Data

R404A	Cooling Capacity (kW)							R404A	Power Input (kW)						
	Ambient Temperature: 32°C								Ambient Temperature: 32°C						
	Evaporating Temperature (°C)								Evaporating Temperature (°C)						
Model	-45	-35	-30	-20	-10	-5	+5	Model	-45	-35	-30	-20	-10	-5	+5
Z9-4MA-22X		11.7	15.3	24.0	34.8	41.0	55.0	Z9-4MA-22X		8.9	10.1	12.5	14.9	16.0	18.2
V6-4MF-13X	4.3*	10.8	13.7	20.4	28.4	32.8		V6-4MF-13X	5.8*	8.2	9.5	12.3	15.3	16.9	
V6-4ML-15X	5.4*	13.0	16.4	23.9	32.6	37.2		V6-4ML-15X	7.1*	9.9	11.5	14.9	18.7	20.6	
Z9-4MH-25X		13.4	17.5	27.3	39.6	46.7	62.8	Z9-4MH-25X		10.2	11.6	14.6	17.6	19.1	22.0
Z9-4ML-15X	5.9*	14.2	18.1	27.7	39.5	46.3		Z9-4ML-15X	7.9*	10.5	12.0	15.0	18.0	19.4	
Z9-4MM-20X	6.8*	15.9	20.1	30.2	42.5	49.4		Z9-4MM-20X	8.7*	11.6	13.1	16.3	19.7	21.3	
W9-4MM-20X	6.3*	14.5	18.1	25.9	34.6	39.2		W9-4MM-20X	7.9*	11.0	12.7	16.5	20.7	23.0	
Z9-4MI-30X		15.4	20.0	30.5	43.1	50.3	66.1	Z9-4MI-30X		11.4	13.0	16.3	19.6	21.2	24.6
Z9-4MJ-33X		17.0	21.8	33.2	46.9	54.6	71.6	Z9-4MJ-33X		12.4	14.2	17.9	21.8	23.8	27.8
W9-4MT-22X	7.2*	15.9	19.7	28.1	37.6			W9-4MT-22X	8.8*	12.4	14.4	18.7	23.6		
Z9-4MT-22X	7.9*	17.7	22.2	33.3	46.9	54.6		Z9-4MT-22X	9.6*	13.0	14.7	18.5	22.4	24.4	
W99-4MK-35X		18.9	24.1	36.5	51.3	59.6	77.8	W99-4MK-35X		14.1	16.2	20.5	25.2	27.6	32.4
Z9-4MU-25X	8.4*	19.2	24.2	36.1	50.7			Z9-4MU-25X	10.5*	14.4	16.5	20.9	25.5		
W99-6MI-40X		22.1	28.2	42.3	58.8	67.9	87.3	W99-6MI-40X		16.8	19.3	24.8	30.6	33.6	40.0
Z9-6MM-30X	10.1*	22.8	28.4	41.8	58.1	67.2		Z9-6MM-30X	12.8*	17.5	20.0	25.3	31.2	34.3	

Conditions: EN13215: Suction Gas Return 20°C, Subcooling 0K

* Conditions: EN13215: Suction Superheat 10K

R407C	Cooling Capacity (kW)							R407C	Power Input (kW)						
	Ambient Temperature: 32°C								Ambient Temperature: 32°C						
	Evaporating Temperature (°C)								Evaporating Temperature (°C)						
Model	-45	-35	-30	-20	-10	-5	+5	Model	-45	-35	-30	-20	-10	-5	+5
Z9-4MA-22X				20.0	30.4	36.7	51.5	Z9-4MA-22X				10.7	12.9	13.9	16.0
Z9-4MH-25X				22.7	34.8	42.0	58.8	Z9-4MH-25X				12.2	14.8	16.1	18.8
Z9-4MI-30X				25.3	38.3	46.0	64.0	Z9-4MI-30X				13.4	16.4	18.0	21.1
Z9-4MJ-33X				27.8	42.0	50.4	69.6	Z9-4MJ-33X				14.8	18.4	20.2	24.3
W99-4MK-35X				31.9	47.7	56.9	77.5	W99-4MK-35X				16.9	21.2	23.5	28.5
W99-6MI-40X				36.2	53.5	63.3	84.5	W99-6MI-40X				20.0	25.5	28.4	34.9

Conditions: EN13215: Suction Gas Return 20°C, Subcooling 0K

Preliminary Data

Capacity Data

R134a		Cooling Capacity (kW)						R134a		Power Input (kW)					
		Ambient Temperature: 32°C								Ambient Temperature: 32°C					
		Evaporating Temperature (°C)								Evaporating Temperature (°C)					
Model	-45	-35	-30	-20	-10	-5	+5	Model	-45	-35	-30	-20	-10	-5	+5
Z9-4MA-22X				14.0	21.9	26.9	39.1	Z9-4MA-22X				7.4	8.8	9.4	10.6
V6-4MF-13X				12.4	19.6	23.8	33.8	V6-4MF-13X				6.6	8.2	9.1	10.9
Z9-4ML-15X				15.7	24.8	30.5	44.0	Z9-4ML-15X				8.3	10.0	10.9	12.5
Z9-4MH-25X				15.8	24.9	30.6	44.4	Z9-4MH-25X				8.5	10.2	11.1	12.6
V6-4ML-15X				14.8	22.9	27.7	38.6	V6-4ML-15X				7.7	9.8	10.9	13.2
W9-4MM-20X				16.4	25.2	30.3	42.1	W9-4MM-20X				8.5	10.8	12.0	14.6
Z9-4MI-30X				17.5	27.2	33.3	47.9	Z9-4MI-30X				9.1	11.0	12.0	13.8
Z9-4MM-20X				17.3	27.1	33.2	47.6	Z9-4MM-20X				9.1	11.0	12.0	13.8
Z9-4MJ-33X				19.5	30.1	36.7	52.4	Z9-4MJ-33X				10.2	12.3	13.4	15.5
Z9-4MT-22X				19.6	30.4	37.1	52.9	Z9-4MT-22X				10.2	12.4	13.6	15.9
W9-4MT-22X				18.5	28.0	33.6	45.9	W9-4MT-22X				9.7	12.3	13.7	16.9
Z9-4MU-25X				21.2	33.3	40.6	57.9	Z9-4MU-25X				11.3	14.0	15.4	18.3
W99-4MK-35X				21.8	33.7	41.0	58.5	W99-4MK-35X				11.2	13.8	15.2	18.0
Z9-6MM-30X				25.3	39.1	47.4	66.7	Z9-6MM-30X				13.3	16.7	18.4	22.1
W99-6MI-40X				25.2	39.0	47.4	67.3	W99-6MI-40X				13.5	16.5	18.2	21.7

Conditions: EN13215: Suction Gas Return 20°C, Subcooling 0K

Refer to Emerson's Select software for R450A and R513A capacity data.

Compressors Motor Codes Table

Semi-Hermetic						
Motor Codes	Voltage	Connection		Motor Codes	Voltage	Connection
Standard Motor Version						
CAG	220-230/1/50	-				
EWL (DK, DL, D2S)	220-240/3/50	Δ		EWN (DK, DL, D2S)	250-280/3/60	Δ
EWL (DK, DL, D2S)	380-420/3/50	Y		EWN (DK, DL, D2S)	440-480/3/60	Y
AWM	380-420/3/50	YY/Y		AWD	440-480/3/60	YY/Y
Special Motor Version						
EWM	380-420/3/50	Δ/Y-Start		EWD	440-480/3/60	Δ/Y-Start
AWR	220-240/3/50	YY/Y		EWK (not D8)	220-240/3/60	Δ
AWY	500-550/3/50	YY/Y		EWK (not D8)	380-420/3/60	Y
				AWC	208-230/3/60	YY/Y
				AWX	380/3/60	YY/Y
Hermetic & Scroll						
Motor Codes	Voltage	Connection		Motor Codes	Voltage	Connection
Standard Motor Version						
PFJ	220-240/1/50	-		PFJ	265/1/60	-
PFT	220-240/1/50	-				
PFZ	220-240/1/50	-				
TFD	380-420/3/50	Y		TFD	460/3/60	Y
TFM	380-420/3/50	Y				
TWD	380-420/3/50	Y		TWD	460/3/60	Y
FWD	380-420/3/50	Δ/Δ				
FWM	380-420/3/50	Δ/Δ				
TWM	380-420/3/50	Y				
Special Motor Version						
TF5	200-220/3/50	Y		TF5	200-230/3/60	Y
TWR	220-240/3/50	Y		TW7	380/3/60	Y
TWC	200/3/50	Y		TWC	208-230/3/60	Y
TFE	500/3/50	Y		TFE	575/3/60	Y
TWE	500/3/50	Y		TWE	575/3/60	Y
				TF7	380/3/60	Y
TW5	200-220/3/50	Y		TW5	220-230/3/60	Y
Variable Speed Motor Version						
*E9	BPM Motor	-				

YY/Y = Part-Winding-Start
 Δ/Δ = Part-Winding-Start



Notes

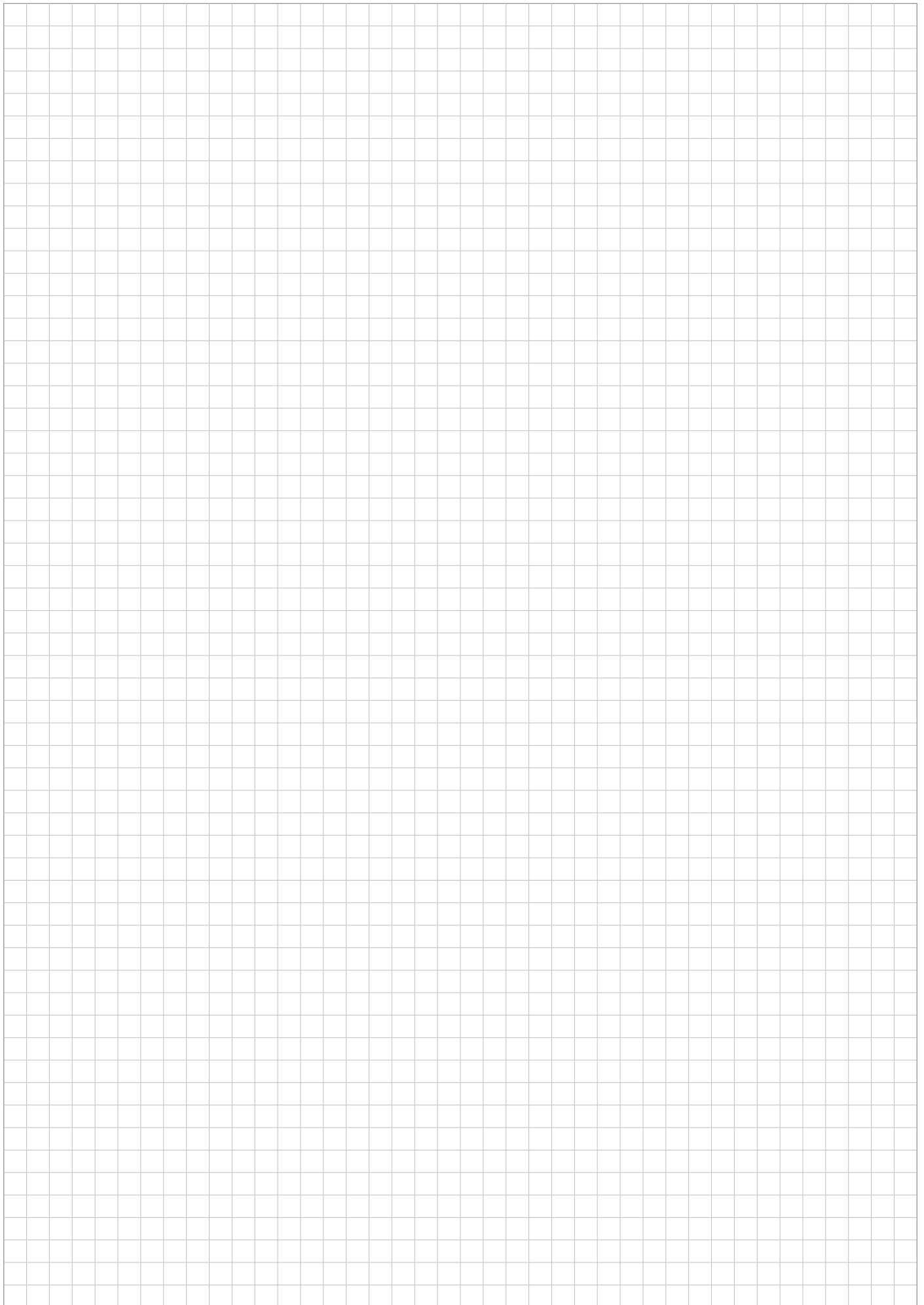

Notes

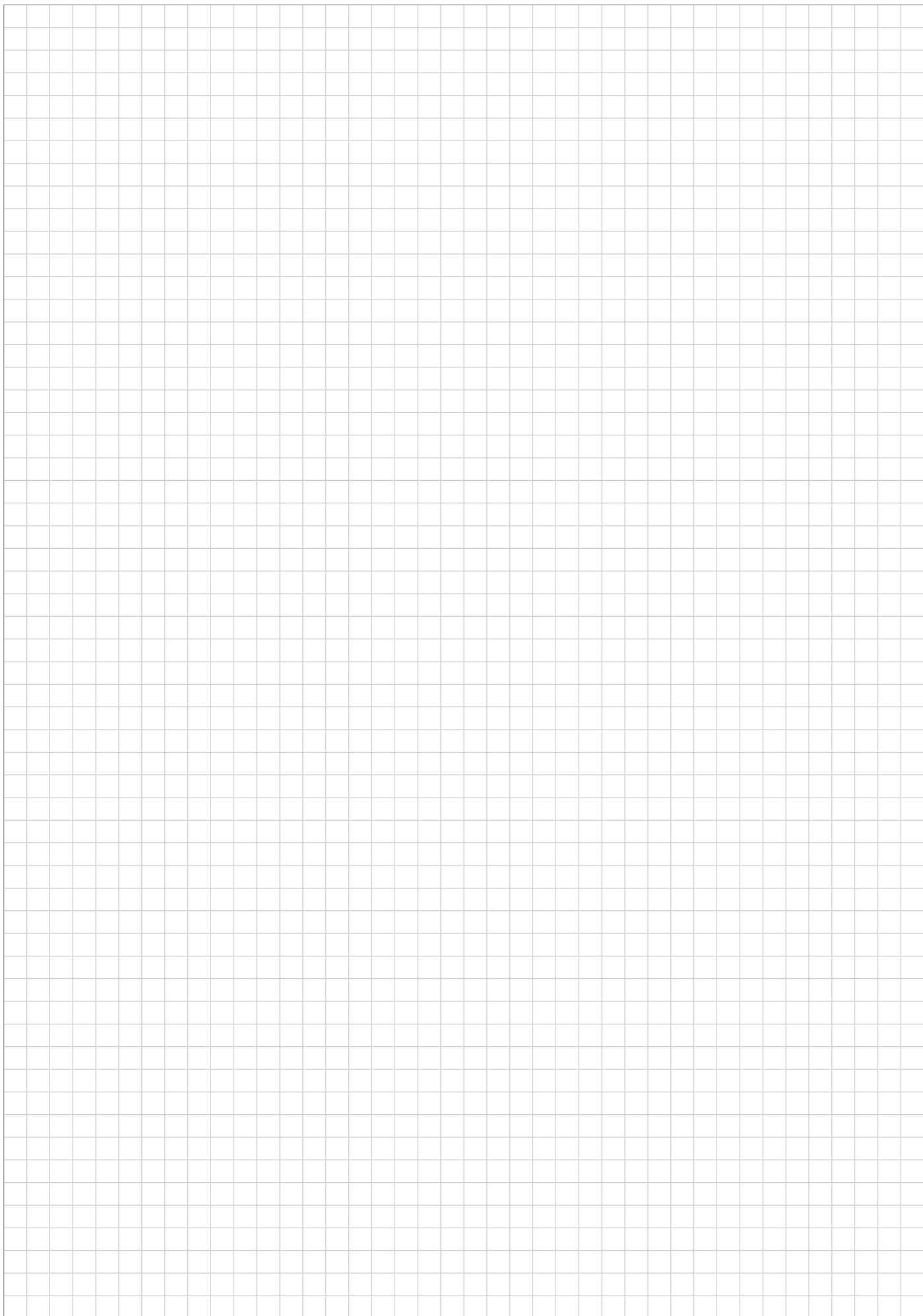



Controls Components

Controls Components

Alco Controls™ is the leading provider of precision mechanical controls for the refrigeration and air conditioning markets, and together with the range of electronic controls from Emerson we continue to pioneer the control of refrigerant flow with innovative design, keeping system performance optimization central to our product development.

The wide range of Emerson controllers covers all major applications in commercial air conditioning and refrigeration, as well as heat pump systems. There are stand-alone controllers and controllers with a communication interface.

The controllers with TCP/IP Ethernet communication feature a full web server function and provide full data exchange with any user in the World Wide Web. This allows quick and inexpensive monitoring from any PC with a standard web browser.

Emerson offers stepper motor drivers and superheat controllers for the electrically driven control valves, as well as capacity controllers for Copeland Digital Scroll compressors. See section “Electronic Controllers and Sensors” for more details.

Display case and cold room controllers provide all functions needed to run commercial refrigeration, like superheat control with electrical control valve, thermostat, fan and defrost control, integrated timer and alarm functions.

The compressor soft starter allows keeping the starting current below the limit imposed in residential heat pump applications.

Electronic fan speed controllers help to maintain a minimum condensing pressure by reducing fan speed at low ambient temperature.

Make use of Alco Controls pressure transmitters, temperature sensors and other assorted accessories compatible with all of the above-mentioned controllers.

Oil management components feature active oil level monitoring and balancing for optimal compressor protection. The patented TraxOil™ 3-zone level control technology is unique and offers comfortable monitoring and proactively protects the compressor against low oil levels.

Emerson’s controls portfolio is completed by offering a variety of mechanical controls such as:

- Pressostats & Thermostats
- System Protectors
- Solenoid Valves
- Ball Valves
- Moisture Indicators
- Thermo™-Expansion Valves
- Oil Separators
- and Suction Accumulators



Electrical Control Valves

Electrical Control Valves

Electrical Control Valve Technology

Thermostatic expansion valves and mechanical regulator valves have been used in the refrigeration and air conditioning industry to control superheat and refrigerant mass flow since its very beginning. As today's systems require improved energy efficiency, tighter temperature control, a wider range of operating conditions and incorporate new features like remote monitoring and diagnostics, the application of electronically operated valves becomes mandatory. Only these offer the controls performance necessary to meet these needs. Electrical control valves are actuators only. For operation in a system they need sensors, valve drivers and controllers, see next chapter.

The **EXM/EXL/EXN** biflow valves for OEM use are equipped with an unipolar stepper motor drive. They are mainly used for heat pumps, air conditioning and close control.

The EX2 is designed for pulse width modulation. It is applicable to common refrigerants and is used mainly for refrigeration applications such as display cases. The EX2 valve is a slide type solenoid valve with an orifice for expansion. It is either completely open or completely closed. One common valve body can be combined with 6 interchangeable orifices to cover 7 capacity ranges. The CX2 features the same technology and advantages as the EX2, however it is applicable to high-pressure CO₂ applications.

The **EX4-8** consist of two main internal assemblies, the valve and the stepper motor. The stepper motor is located next to the electrical plug and connected directly to the slide and cage assembly of the valve. Similar to the technology used in

compressors, the motor is exposed to refrigerant and lubricant and the materials used are identical to the ones in compressor motors. The housing of the motor and valve assembly is made from stainless steel and fully hermetic, utilising exclusively brazing and welding technologies and eliminating all gaskets. This design offers several technical advantages such as proportional linear mass flow and a wide capacity range. A common feature of all EX2, EX4-8 electrical control valves is the positive shut-off function, which eliminates the need for additional solenoid valves.

The **CX4/CX5/CX6/CX7** High Pressure Expansion Valves are stepper motor driven valves for precise control of R744 (CO₂) refrigerant mass flow in air conditioning, refrigeration and heat pump applications. The Control Valves also can be used for liquid injection duty and hot gas bypass.

Valve Selection

For the EX2, the published table quotes capacities at 100% duty cycle, i.e. valve open continuously. However, it is recommended to operate the valve at partial load (50-80%) to allow for system load fluctuations. For **EX4-8**, **FX5-9** and **EXM/EXL/EXN** valves, all published capacities are maximum and there are no reserve capacities. Each valve should be selected for the highest possible capacity of the system. A wide range regulation (10 ... 100%) with one slide orifice for each valve is achievable. To facilitate valve dimensioning for other than the standard conditions, Emerson Climate offers the program "Controls Navigator". This can be downloaded from www.emersonclimate.eu.



Selection Table for Electrical Control Valves and Applicable Controllers

Valve Type	Function	Capacity kW R407C	Feature	Main Application	Applicable Controller
EXM EXL	Expansion Valve	5 .. 20.7	Uni Polar Stepper Motor Driven	Heat pumps, Air Conditioning, Close Control	EXD-HP1/2 Superheat Controller (Modbus)
EX2	Expansion Valve	1.0 .. 18.7	PWM	Refrigeration (Display cases)	EC2
EX4-8	Expansion Valve, Hot Gas Bypass, Condensing Pressure And Liquid Regulator, Head Pressure Control, Suction/Crankcase Pressure Regulator, Heat Reclaim	2 .. 925 (Capacity Data as Expansion Valve)	Bi Polar Stepper Motor Driven	Refrigeration, Air Conditioning, Water Chillers, Heat Pumps	EXD-U01 Driver Module EXD-SH1/2 Superheat Controller (Modbus) EC3-X Superheat Controller (TCP-IP) EC3-3 Coldroom Controller
EXN	Expansion Valve	30 .. 38	Uni Polar Stepper Motor Driven	Heat Pumps, Air Conditioning, Close Control	EXD-HP1/2 Superheat Controller (Modbus)
FX5-9	Expansion Valve	54 .. 2310	Bi Polar Stepper Motor Driven	Air Conditioning, Heat Pumps, Close Control	EXD-SH1/2 Superheat Controller (Modbus) EC3-X Superheat Controller (TCP-IP)

Selection Table for Electrical Control Valves and Applicable Controllers for CO₂ Applications

Valve Type	Function	Capacity kW R744	Feature	Main Application	Applicable Controller
CX2	Expansion Valve	1.5 .. 28.2	PWM	Refrigeration (Display Cases)	EC2
CX4-7	High Pressure Gas Valve For Gas Cooler Control Expansion Device Hot Gas Bypass Head Pressure Control Suction/Crankcase Pressure Regulator Heat Reclaim	For Capacity Data For Various Applications (Expansion, Hot Gas Bypass Etc.) Please Refer to the Controls Navigator	Bi Polar Stepper Motor Driven	Refrigeration	EXD-U01 Universal Driver Module EXD-SH1/2 Superheat/Temperature Controller

Electrical Control Valves Series EXM/EXL for OEM Use, Stepper Motor Driven

Features

- Unipolar stepper motor
- Bi-flow (same performance in both flow directions in term of capacity)
- High MOPD: 40 bar in normal flow direction
- Removable coils in two versions: 12VDC/24VDC
- Continuous modulation of mass flow, no stress (liquid hammering) in the refrigeration circuit
- Linear flow
- Resolution: 500 pulses (half steps) or 250 full steps
- Hermetic design
- Reliability: 225 millions pulses at continuous 40 bar differential pressure



EXM/EXL

Note: The valve is not released for refrigeration applications such as cold rooms and refrigeration display cabinets.

Selection Table

Valve Series	Type	Description	Part No. *	Nominal Capacity kW			Connections Size / Style
				R410A	R407C	R134a	
EXM	EXM-B0A	Valve less coil	800 399M	1.8	1.6	1.2	¼" ODF
	EXM-B0B	Valve less coil	800 400M	5.5	5.0	3.7	
	EXM-B0D	Valve less coil	800 401M	11.6	10.5	7.7	
	EXM-B0E	Valve less coil	800 402M	13.7	12.4	9.1	
	EXM-125	Coil 12VDC	800 403M	-	-	-	-
	EXM-24U	Coil 24VDC	800 415M	-	-	-	-
EXL	EXL-B1F	Valve less coil	800 405M	17.0	15.4	11.3	¼" ODF
	EXL-B1G	Valve less coil	800 406M	23.0	20.7	15.2	8 mm ODM
	EXL-125	Coil 12VDC	800 407M	-	-	-	-
	EXL-24U	Coil 24VDC	800 416M	-	-	-	-

Note: *) Only Bulk packing in boxes of 10 identical pieces

The nominal capacity is based on the following conditions:

Refrigerant	Evaporating Temperature	Condensing Temperature	Subcooling
R407C	+4°C (Dew Point)	+38°C Bubble Point / +43°C Dew Point	1K
R134a, R410A	+4°C	+38°C	1K

Note: For selection of other operating conditions, please use the "Controls Navigator" selection tool.

Technical Data

Max. Allowable Pressure PS	45 Bar
MOPD	40 Bar in Normal Flow Direction
Temperature Range TS	-30...+70°C (Liquid Refrigerant) -30...+60°C (Ambient)
Stepper Motor Type	Uni-polar, Constant Voltage

Full Travel Time	16.6 Seconds at 30 Pulse/Sec. 5.5 Seconds at 90 Pulse/Sec.
Reference Position	Mechanical Stop at Fully Close Position
Total Number of Pulses	500 Half Step (250 Full Step)
Insulation Class	EXM: A EXL: E
Cable Length	1m

Electrical Control Valves Series EXN for OEM Use, Stepper Motor Driven

Features

- Unipolar stepper motor
- Bi-flow with same capacity in normal and reverse flow direction
- MOPD: 36 bar in both flow directions
- Unipolar stepper motor with gear mechanism enabling Bi-flow performance at 36 bar differential pressure across the valve
- Removable coil: 12 VDC
- Continuous, linear modulation of mass flow
- High resolution: 2000 pulses (half steps) or 1000 full steps
- Hermetic design



EXN with Coil

Selection Table

Type	Description	Part No.	Nominal Capacity [kW]				Connections Size / Style
			R410A	R32	R134a	R407C	
EXN-B2K	Valve less coil	800421	34	50.6	22.2	30.7	1/2" ODF
EXN-B2L	Valve less coil	800422	42	62.5	28.8	37.9	1/2" ODF
EXN-125	Coil 12VDC	800420	-	-	-	-	-

The nominal capacity (Q_n) is based on the following conditions:

Refrigerant	Evaporating Temperature	Condensing Temperature	Subcooling
R410A, R134a, R32	+4°C	+38°C	1K
R407C	+4°C Dew Point	+38°C Bubble / +43°C Sew Point	1K

Note: For selection of other operating conditions, please use the "Controls Navigator" selection tool.

Technical Data

MOPD (Maximum Operating Pressure Differential)	36 Bar in Normal Flow 36 Bar in Reverse Flow
Max. Working Pressure PS	45 Bar
Temperature Range TS - liquid refrigerant - Ambient	-30...+70°C -30...+60°C
Stepper Motor Type	Uni-Polar, Constant Voltage, 5 Wires
Supply Voltage	12 VDC Coil: 12 V ± 10%

Total Number of Pulses	2000 Half Step (1000 Full Step)
Pulsing Rate Frequency (Pulse/Sec.)	100...200 Hz
Full Travel Time	20 Seconds at 100 Hz 10 Seconds at 200 Hz
Coil Insulation Class	A
Cable Length	1 m
Electrical Connection	JST XH connector, 5 pole Housing: XHP-5 Pin: SXH-001T-P0.6

Electronic Expansion Valves Series EX2 Pulse Width Modulated With Exchangeable Orifices Can Be Used With EC2 Display Case Controllers

Features

- Pulse width modulated
- Shut-off function eliminates the necessity of a separate solenoid valve
- Dampened plunger reduces noise effects of water hammer
- One valve body can be combined with 6 orifices to make 7 capacity ranges
- Long lifetime, high reliability
- Max. working pressure PS: 40 bar
- Medium temperature range TS: -40...+65°C

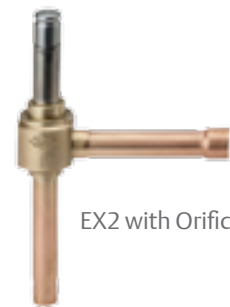

EX2 with Orifice

Selection Table

Type	Part No.	Description	Nominal Capacity Q_n at 100% Open Valve (kW)*								
			R134a	R22	R404A / R507	R407C	R448A	R449A	R450A	R513A	R1234ze
EX2-M00	801091	Valve less orifice 10 mm x 12 mm	13.3	17.2	12.1	18.7	17.2	16.8	11.7	12.0	10.4
EX2-I00	801090	Valve less orifice 3/8"x 1/2"									
EXO-004	801089	Orifice 4	8.5	10.9	7.7	11.8	10.9	10.6	7.4	7.6	6.6
EXO-003	801088	Orifice 3	5.6	7.2	5.1	7.8	7.2	7.0	4.9	5.0	4.4
EXO-002	801087	Orifice 2	3.3	4.3	3.0	4.7	4.3	4.2	2.9	3.0	2.6
EXO-001	801086	Orifice 1	2.5	3.2	2.3	3.5	3.2	3.1	2.2	2.2	1.9
EXO-000	801085	Orifice 0	1.2	1.6	1.1	1.7	1.6	1.6	1.1	1.1	1.0
EXO-00X	801084	Orifice X	0.7	0.9	0.6	1.0	0.9	0.9	0.6	0.6	0.5

Note 1: *) Orifice should be selected at maximum 80% of Q_n to allow covering the load fluctuation.

The nominal capacity (Q_n) is based on the following conditions:

Refrigerant	Evaporating temperature (°C)	Condensing temperature (°C)	Subcooling
R407C, R448A, R449A	+4°C dew point	+38°C bubble / +43°C dew point	1K
R22, R134a, R404A, R507	+4°C	+38°C	
R744	-40°C	-10°C	
R450A	+4°C dew point	+38°C bubble / +38.6°C dew point	
R513A, R1234ze	+4°C dew point	+38°C bubble / +38°C dew point	

Note: For selection of other operating conditions, please use "Controls Navigator" selection program.

Accessories

Type	Part No.	Part No. (Multipack*)	Description	
ASC 24V	801062	-	Coil 24 VAC / 50 Hz	
ASC 230V	801064	-	Coil 230 VAC / 50 Hz	
ASC-N15	804570	804570M	Connector Cable Assembly	
ASC-N30	804571	804571M		1.5 m cable length
ASC-N60	804572	-		3.0 m cable length
Plug PG9	801012	-	Plug with cable guide	
Plug PG11	801013	-		
Clip Holder	801295	-	Blue clip	

Note: *) Multipack = 20 pcs

Electronic Expansion Valves Series CX2 Pulse Width Modulated With Exchangeable Orifices for High-Pressure CO₂ Applications Can Be Used With EC2 Display Case Controllers

Features

- Pulse width modulated
- Shut-off function eliminates the necessity of a separate solenoid valve
- Dampened plunger reduces noise effects of water hammer
- One valve body can be combined with 6 orifices to make 7 capacity ranges up to 28.2 kW
- Long lifetime, high reliability
- Max. working Pressure PS: 90 bar
- MOPD: 65 bar



CX2 with Orifice

Selection Table

Type	Part No.	Description	Nominal capacity (kW) at 100% continuous open R 744
CX2-100	801095	Valve: 3/8" x1/2" ODF	28.2
EXO-004	801089	Orifice 4	17.9
EXO-003	801088	Orifice 3	11.8
EXO-002	801087	Orifice 2	7.0
EXO-001	801086	Orifice 1	5.2
EXO-000	801085	Orifice 0	2.6
EXO-00X	801084	Orifice X	1.5

Note:

1) Nominal capacity at -10°C evaporating temperature, +10°C liquid temperature (45 bar) and 1K subcooling. For other operating conditions, please see quick selection table or Control Navigator selection software (Feb. 2015)

2) The table quotes capacities at 100% duty cycle, i.e. valve is open continuously. However, it is recommended to operate the valve at partial loaded (50-80%) to allow for system load fluctuations. When used with an EC2 case controller, the valve operates with a 6 second pulse width cycle.

3) CX2 is released as expansion valve and during operation of valve CO2 must be feed in liquid phase to inlet of the valve.

Accessories

Type	Part No.	Part No. (Multipack*)	Description	
ASC 24V	801062	-	Coil 24 VAC / 50 Hz**	
ASC 230V	801064	-	Coil 230 VAC / 50 Hz**	
ASC-N15	804570	804570M	Connector Cable Assembly	
ASC-N30	804571	804571M		1.5 m cable length
ASC-N60	804572	-		3.0 m cable length
Plug PG9	801012	-	Plug with cable guide	
Plug PG11	801013	-		6.0 m cable length
Clip Holder	801295	-	Blue clip	

Note: *) Multipack = 20 pcs **) 50Hz coils have lower MOPD with 60Hz frequency.

MOPD levels depending on supply voltage to coil

MOPD	Supply voltage to coil	Supply voltage to coil
65 bar	24 VAC nominal voltage	230 VAC nominal voltage
60 bar	24 at -5% = 22.8 VAC	230 at -5% = 218.5 VAC
50 bar	24 at -10% = 21.6 VAC	230 at -10% = 207 VAC
45 bar	24 at -15% = 20.4 VAC	230 at -15% = 195.5 VAC

Note: MOPD values are valid only for 50 Hz supply voltage operation.

Electrical Control Valves Series EX4-8

Features

- Multifunction as expansion valve, hot gas bypass, suction gas throttling, head pressure, liquid level actuator etc.
- Fully hermetic design (no thread joints between valve body and motor compartment)
- Applicable to all common refrigerants and for subcritical CO₂ applications
- Stepper motor driven
- Short opening and closing time
- Very fast full-stroke time
- High resolution and excellent repeatability
- Positive shut-off function to eliminate the need for additional solenoid valve
- Bi-flow versions for heat pump applications
- High linear flow capacity
- Extremely wide capacity range (10 ... 100%)
- Continuous modulation of mass flow, no stress (liquid hammering) in the refrigeration circuit
- Direct coupling of motor and valve for high reliability (no gear mechanism)
- Ceramic slide and port for highly accurate flow and minimal wear
- Europe patent No. 0743476, USA patent No. 5735501, Japan patent No. 28225789
- Balanced force design
- Corrosion resistant stainless steel body and stainless steel connections



Selection Table (Capacities See Following Page)

Type	Part No.	Flow Pattern	Capacity Range	Inlet Connection	Outlet Connection	Electrical Connection
EX4-I21	800 615	Uni-flow	10 ... 100%	3/8" ODF	5/8" ODF	M12 Plug
EX4-M21	800 616			10mm ODF	16mm ODF	
EX5-U21	800 618			5/8" (16mm) ODF	7/8" (22mm) ODF	
EX6-I21	800 620			7/8" ODF	1-1/8" ODF	
EX6-M21	800 621			22mm ODF	28 mm ODF	
EX7-I21	800 624			1-1/8" ODF	1-3/8" ODF	
EX7-M21	800 625			28mm ODF	35mm ODF	
EX8-M21	800 629			42mm ODF	42mm ODF	
EX8-U21	800 630			1-3/8" (35mm) ODF	1-3/8" (35mm) ODF	
EX8-I21	800 631			1-5/8" ODF	1-5/8" ODF	
EX4-U31	800 617	Bi-flow (Heat Pump)		5/8" (16mm) ODF	5/8" (16mm) ODF	
EX5-U31	800 619			7/8" (22mm) ODF	7/8" (22mm) ODF	
EX6-I31	800 622			1-1/8" ODF	1-1/8" ODF	
EX6-M31	800 623			28mm ODF	28mm ODF	
EX7-U31	800 626			1-3/8" (35mm) ODF	1-3/8" (35mm) ODF	

Cable Connector Assemblies

Type	Part No.	Temperature Range	Length	Connector Type to Valve	Connector Type to Driver or Controller	Illustration
EXV-M15	804 663	-50 ... +80°C	1.5 m	M12, 4 Pins	Loose Wires	
EXV-M30	804 664		3.0 m			
EXV-M60	804 665		6.0 m			

Capacity Data

Nominal capacities...

...as expansion valves and liquid injection valves, (kW) (10%...100%)

Type	R410A	R134a	R22	R404A / R507	R407C	R407A	R407F	R1234ze	R448A	R449A	R450A	R513A	R744	R124	R23
EX4	19.3	12.8	16.5	11.5	17.4	16.2	18.4	10.0	16.5	16.1	11.3	11.5	27.0	9.4	17.8
EX5	58.1	39.0	50.0	35.0	53.0	49.0	56.0	30.2	49.9	48.7	34.1	34.9	82.0	28.7	54.0
EX6	140	93	120	84	126	118	134	72	120	117	82	84	197	69	130
EX7	385	255	330	230	347	325	369	199	329	321	225	230	540	-	-
EX8	1028	680	880	613	925	866	984	531	877	857	600	614	1440	-	-

Note 1: Bi-flow versions are not released for use with R124 and R23 refrigerants.

Note 2: Bi-flow versions have identical capacity in both flow directions.

...as hot gas bypass regulator, (kW)

Type	Kv [m ₃ /h]	R410A	R134a	R22 / R407C	R404A / R507	R407A	R407F	R1234ze	R448A	R449A	R450A	R513A
EX4	0.21	7.3	3.4	4.9	4.7	5.6	6.2	2.6	5.7	5.6	3.0	3.3
EX5	0.68	23.7	11.1	15.9	15.2	18.1	20.1	8.3	18.6	18.3	9.7	10.8
EX6	1.57	55.0	25.8	36.9	35.4	42.1	46.7	19.3	43.2	42.5	22.6	25.2
EX7	5.58	196	92	131	126	150	166	69	154	151	80	89
EX8	16.95	594	278	399	382	454	504	209	466	459	244	272

Note: Bi-flow versions are not released for hot gas flow applications.

...as suction pressure regulator (evaporator or crankcase), (kW)

Type	Kv [m ₃ /h]	R410A	R134a	R22	R404A	R507	R407C	R407A	R407F	R1234ze	R448A	R449A	R450A	R513A
EX6	1.57	5.0	3.1	4.1	3.5	3.5	3.9	3.8	4.2	2.5	3.9	3.8	2.8	3.0
EX7	5.58	17.9	11.1	14.7	12.5	12.5	13.7	13.5	14.8	9.0	13.8	13.6	9.9	10.6
EX8	16.95	54.5	33.6	44.5	38.1	37.9	41.8	41.1	45.1	27.4	42.0	41.4	30.1	32.2

Note: Bi-flow versions are not released for use below -40°C

...as condensing pressure regulator and liquid duty, (kW)

Type	Kv [m ₃ /h]	R407C	R134a	R22	R404A	R507	R407A	R407F	R1234ze	R448A	R449A	R450A	R513A
EX4	0.21	5.7	5.6	6.0	4.0	3.8	5.3	5.8	5.1	5.3	5.2	5.3	5.0
EX5	0.68	18.5	18.3	19.6	12.9	12.5	17.1	18.8	16.5	17.1	16.8	17.0	16.3
EX6	1.57	43.0	42.4	45.5	29.9	29.0	39.7	43.8	38.3	39.9	39.1	39.6	37.8
EX7	5.58	153	151	162	106	103	141	156	136	142	139	141	134
EX8	16.95	464	458	491	323	313	428	473	413	430	422	428	408

...for hot gas flow such as heat reclaim application, (kW)

Type	Kv [m ₃ /h]	R410A	R134a	R22 / R407C	R404A / R507	R407A	R407F	R1234ze	R448A	R449A	R450A	R513A
EX6	1.57	13.0	9.0	10.8	9.8	11.1	12.0	7.4	11.3	11.2	8.2	8.5
EX7	5.58	46	32	38	34	39	43	26	40	40	29	30
EX8	16.95	141	96	116	103	120	129	79	122	120	88	92

Note: Bi-flow versions are not released for hot gas flow applications.

The nominal capacity is based on the following conditions:

Refrigerant	Evaporating temperature	Condensing temperature	Pressure drop (suction duty)	Pressure drop (liquid duty)	Pressure drop (hot gas flow duty)	Isentropic efficiency (For hot gas flow duty)
R124	+20°C	+80°C	0.15 bar	0.35 bar	0.5 bar	80%
R134a, R404A, R507, R22, R410A, R513A, R1234ze	+4°C dew point	+38°C bubble/ +38°C dew point				
R407C	+4°C dew point	+38°C bubble/ +42.9°C dew point				
R407F, R407A	+4°C	+38°C bubble/ +42.4°C dew point				
R23	-60°C	-25°C				
R744	-10°C	+10°C				
R450A		+38°C bubble/ +38.6°C dew point				
R448A, R449A		+38°C bubble/ +42.6°C dew point				

Note: For selection of other operating conditions, please use "Controls Navigator" selection program.

Electronic Expansion Valves FX Series

Emerson FX are stepper motor driven electronic expansion valves for precise control of refrigerant mass flow in air conditioning, heat pumps, close control, and industrial process cooling applications.

Features

- Flexibility by configuration of outlet connection in 4 directions
- Stepper motor driven
- High resolution and excellent repeatability
- Linear flow capacity
- Extremely wide capacity range (10...100%)
- Continuous modulation of mass flow, no stress (liquid hammering) in the refrigeration circuit
- Direct coupling of motor and valve for high reliability (no gear mechanism)



FX7

Selection Table

Type	Part No.	Inlet Connection ODF	Outlet Connection ODF	Electric Connection
FX5-U07	801 336	7/8"	7/8"	Suitable for M12 plug (order separately)
FX6-I09	801 337	1-1/8"	1-1/8"	
FX6-M28	801 338	28 mm	28 mm	
FX6.5-I09	801 339	1-1/8"	1-1/8"	
FX6.5-M28	801 340	28 mm	28 mm	
FX7-U11	801 341	1-3/8"	1-3/8"	
FX7.5-U11	801342	1-3/8"	1-3/8"	
FX8-I13		1-5/8"	1-5/8"	
FX8-M42		42 mm	42 mm	
FX9-U17	801 345	2-1/8"	2-1/8"	

Cable and Connector Assembly

Type	Part No.	Temperature Range	Length	Connector Type to Valve	Connector Type to Driver Board or Controller	Illustration
EXV-M15	804 663	-50 ... +80°C	1.5 m	M12	Loose wires	
EXV-M30	804 664		3.0 m			
EXV-M60	804 665		6.0 m			

Nominal Capacities, kW

Valve Type	R134a	R410A	R407C	R22	R450A	R513A	R1234ze
FX5	40	60	54	52	27.3	27.9	31.3
FX6	90	136	123	116	65	66	74
FX6.5	145	220	200	190	99	101	113
FX7	300	450	400	390	211	216	242
FX7.5	460	700	630	600	314	321	360
FX8	730	1100	990	944	498	510	571
FX9	1700	-	2310	2200	1159	1187	1329

Note: Nominal Capacities of FX7.5/8/9 Might Be Modified. Please Contact Sales Office.

The nominal capacity is based on the following conditions:

Refrigerant	Evaporating Temperature	Condensing Temperature	Subcooling
R134a, R410A & R22	+4°C	+38°C	1K
R407C	+4°C (Dew Point)	+38°C bubble point / +43°C dew point	
R513A & R1234ze	+4°C	+38°C bubble point / +38°C dew point	
R450A	+4°C (Dew Point)	+38°C bubble point / +38.6°C dew point	

Note: For selection of other operating conditions, please use the "Controls Navigator" selection tool.

Bi-Flow Application

FX valves are able to be operated in Bi-flow direction such as reversible heat pump with following consideration:

Valve	Max. Operating Differential, bar		Capacity	
	Normal Flow Direction	Reverse Flow Direction	Normal Flow Direction	Reverse Flow Direction
FX5	40	30	Normal capacity on previous page	The same capacity
FX6	35	30		
FX6.5	35	30		

Technical Data

CE Marking FX5/6/6.5: FX7/7.5/8/9:	Not Required Required, Cat I, Module A
Max. Working Pressure PS	FX5-8: 46 bar FX9: 35 bar
Ambient Temperature Storage Temperature	-40...+55°C -40...+70°C
Medium Inlet Temperature	TS: -35...+75°C
Approval	UL (Pending)
Protection Accordance to IEC 529, DIN 40050	IP67 with EMERSON EXV-Mxx Plug and Cable Assembly
Package and Delivery (Individual)	Without Electrical Connector
Connections	ODF Copper
Evaporating Temperature	-35...+40°C

Stepper Motor Type	Bi-Polar, Phase Current (Constant Current)
Electrical Connection	4 Pin Terminal Via Plug
Supply Voltage	24 VDC (Nominal)
Phase Current, Operating	FX5-9: 800 mA
Total Number of Steps	FX5-7: 2400 Full Steps FX7.5: 2500 Full Steps FX8: 2600 Full Steps FX9: 3200 Full Steps
Step Mode	Full Step, Half Step or Micro Step
Stepping Rate	330 Hz
Reference Position	Mechanical Stop at Fully Close Position
Full Travel Time	FX5-7: 7.3 Seconds FX7.5: 7.6 Seconds FX8: 7.9 Seconds FX9: 9.7 Seconds



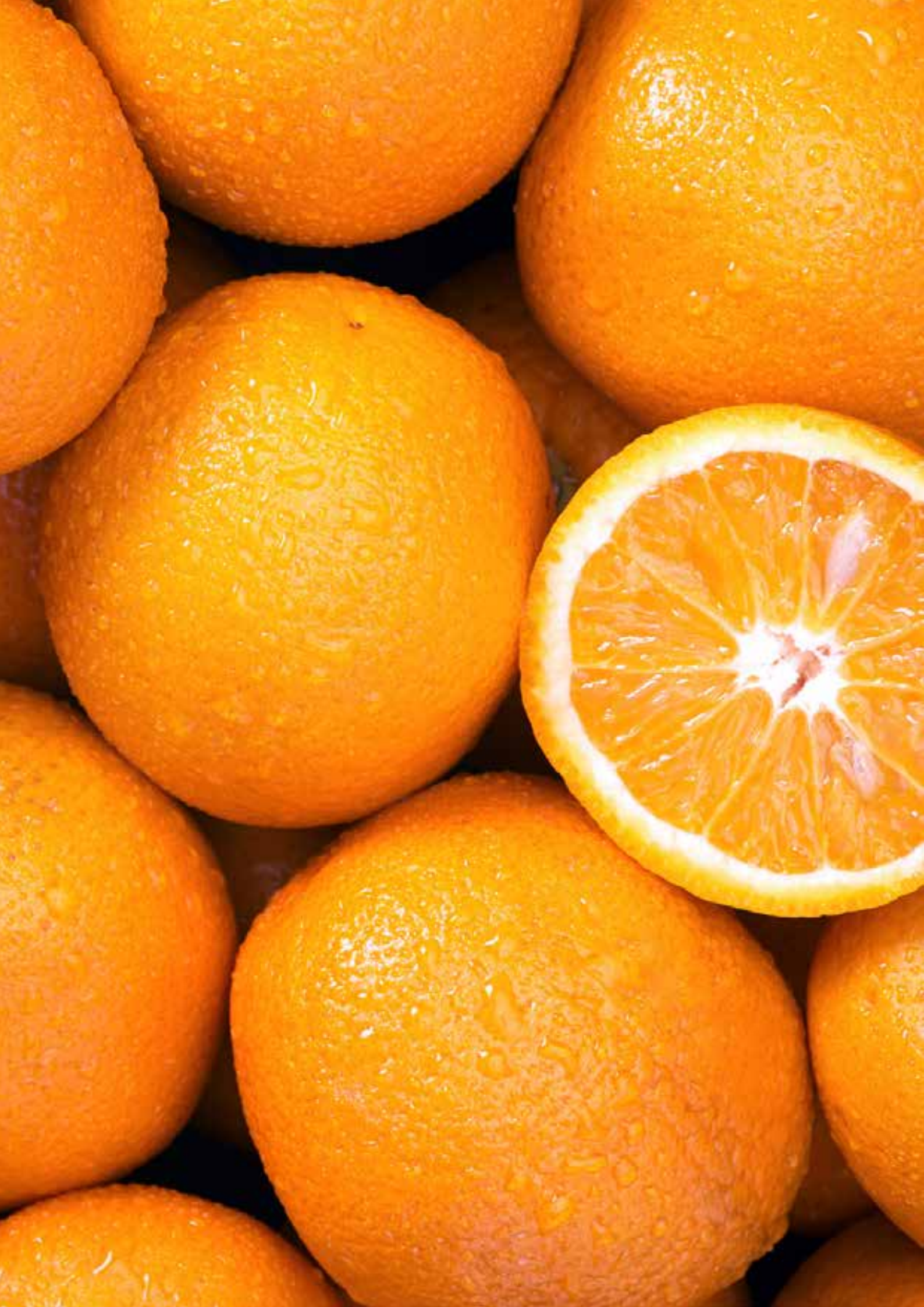

Electronic Controllers and Sensors



Selection Table Electronic Controllers

Description	Network Communication		
	Without	TCP/IP	Modbus
Superheat Controllers and Stepper Motor Drivers			
Superheat Controller for Electrical Control Valves EX4-8 and FX5-9	EC3-X33	EC3-X32	
Digital Superheat Controller For Electrical Control Valves EX4-6	EC3-D73	EC3-D72	
Universal Stepper Driver Module for Electrical Control Valves EX4-8	EXD-U01		
Superheat Controller for Electrical Control Valves EX4-8 and FX5-9			EXD-SH1/2
Superheat Controller for Electrical Control Valves EXM/L			EXD HP1/2
Economizer Controller for Tandem Compressors			
Enhanced Wet Vapor Injection with EXM/L			EXD TEVI
Display Case and Cold Room Controllers for Electrical Control Valve			
Temperature + Superheat Control of EX4-8 (Stepper Motor)		EC3-332	
Condensing Unit Controllers			
For 1 Copeland Scroll Digital™ and 1 Single Stage or 2 Single Stage Compressors, Fan Speed Control		EC2-552	
Pressure Transmitter			
Output Signal 4 ... 20mA	PT5		
Temperature Sensors			
NTC / PT1000	ECN-N/ECP-P...		
Compressor Soft Starter			
For Single Phase Compressor Motors with Up to 32A	CSS		
Electronic Fan Speed Controllers			
Pressure Actuated, Current Range 0.1 ... 4A	FSY/FSM		
Fan Speed Control Modules for EC-Type Motors	FSE		



Electronic Superheat Controllers and Stepper Motor Drivers

Emerson designs superheat controllers and valve drivers for stepper motor driven control valves for all commercial refrigeration and air conditioning applications.

The EC3-X33 is a universal superheat controller without network communication for air conditioning, refrigeration and industrial applications such as chillers, industrial process cooling, rooftops, heat pumps, package unit, close control, cold room, food process and air driers. The ECD-002 Display/Keypad Unit is necessary for setup but not for operation of the controllers. ECD-002 can be connected or disconnected to the EC3-X33 at any time.

In the event of a cooling request and compressor start-up, the EC3-X33 needs to be informed. This can be achieved by a digital input. The EC3-X33 will start to control the refrigerant mass flow stand-alone by precise positioning of the Control Valve under different operating conditions such as compressor start-up, start of a further compressor, high head pressure, low head pressure, high load, low load and partial load operation. EC3-X33 is capable for diagnostics and alarm. The alarm can be received via relay output as well as optical LED/alarm code on ECD-002.

The EC3-X32 has the same function as EC3-X33 but with a TCP/IP Ethernet communication interface enabling the controller to be directly connected to a network or a PC via the standard Ethernet port. The EC3-X32 controller has embedded WebPages to enable the user to visualise the parameter list with a standard WebBrowser like Internet Explorer®. When suitably connected, the controller is able to automatically send alarms by email to a PC or mobile phone.

For use with Copeland Scroll Digital™ technology two other models are available. EC3-D73 is a stand-alone version for use with the ECD-002 Display / Keypad unit whilst the EC3-D72 has a TCP/IP Ethernet interface. A 0-10 V demand signal is required from a third party controller to control a tandem system with one fixed and one digital compressor. A patented algorithm synchronises the operation of the PWM digital compressor valve and the EX series electrical control valve.

EXD-U01 Universal Drivers are stepper motor drivers and enable the operation of stepper motor driven valves EX4...EX8 as electronic expansion valve, capacity control by means of hot gas bypass or evaporating pressure regulator, crankcase pressure regulator, condenser pressure regulator, liquid level and liquid injection.

The EXD-U01 universal driver can be connected to any controller which can provide a 4-20 mA or 0-10 V analogue signal. The output is the opening/closing of EX4-8 and consequently the control of the refrigerant liquid or vapor mass flow in accordance with the analogue input.

EXD-SH1/2 and EXD-HP1/2 are superheat controllers and or economizer controllers with Modbus communication.

Coldroom Controllers

The EC3-332 series are specifically for use with stepper valve series (EX4-8). In case of power loss, the Electrical Control Valve needs to be closed to avoid flooding of the compressor, therefore each valve requires a battery backup. For this reason, the battery, together with its automatic charging circuit, has been incorporated into the controller housing, significantly saving installation time as well as space in the electrical enclosure.

Condensing Unit Controllers

The EC2-552 controller is suitable for controlling the compressors and fans of a condensing unit. Digital inputs are available for individual compressor feedback loops from the safety chain, which typically consists of low and high pressure switches together with motor protection and oil management controls. A common feedback is also available for the fans.

Following models is available:

EC2-552: to control up to 2 single stage compressors or tandem compressor condensing units with a Copeland Scroll Digital™ compressor. It features a 0-10 V output to control fan motor speed with an inverter or to connect to ECM type fan motors directly.

PT5 series pressure transmitters are used to measure the suction and discharge pressures to modulate the compressor and fan capacities.

ECN Temperature sensors (NTC/PT1000) are used to measure the suction and discharge temperatures.

Network Communication and System Management

The Emerson EC Series of drivers and controllers utilise the very latest in communication technology which sets new standards in the refrigeration industry. Energy saving algorithms are incorporated into many of the controllers, including adaptive superheat and thermostat modulation, defrost on demand & suction and discharge setpoint shift.

EC2 or EC3 controllers are available with TCP/IP Ethernet communication protocol.

TCP/IP Ethernet:

The controllers are Ethernet based enabling them to be connected directly to any computer via the Ethernet port (RJ45 connector). The controllers act as web server enabling the engineer to pick up standard configuration pages directly from the controllers without the need of any additional hardware or software. The most convenient way to connect a controller to the PC is to use a router that will automatically assign a TCP/IP address. The engineer can access the monitoring and parameter configuration pages by entering the TCP/IP number into the address line of an Internet browser such as Mozilla or Microsoft Internet Explorer. User name and password protection is provided to protect the controller from unauthorized access.

The TCP/IP based Controllers offer a practical solution, particularly for smaller installations that require communication for monitoring purposes without the need for customized visualization. For many installations, an additional monitoring server is not required.

Other Functions:

- Monitoring of system temperatures and pressures as well as relay status information
- Read/write of EC2 & EC3 control parameters
- Real-time graphical visualization
- Log function of up to one month's data directly on the controller
- Log function of data to a PC *
- Storage and retrieval of system parameter

* Controller must be connected to the PC



Superheat Controllers Series EC3-X32 / EC3-X33

For stable superheat control with stepper motor driven electrical control valves Series EX4-8 and FX5-9

Digital Superheat Controllers Series EC3-D72 / EC3-D73

For stable superheat control only with EX4-6 electrical control valves and automatic synchronisation of the PWM capacity control valve incorporated into the Copeland Scroll Digital™ compressor technology



EC3-X33 with ECD-002

Features

- Limitation of evaporating pressure (MOP)
- Feed-through of 20 mA signal of evaporating pressure transmitter to operate third party controllers with a common pressure transmitter
- Intelligent alarm management, superheat alarm
- Monitoring of sensors and sensor wiring, detection of sensor and wiring failures
- Integral rechargeable battery to close Electrical Control Valve in case of power loss
- Electrical connection via plug-in type screw terminals
- Aluminum housing for DIN rail mounting

Additional Features EC3-X32 and EC3-D72 With TCP/IP

- WebServer functionality allows monitoring and configuration of controllers through a standard Web browser (e.g. Internet Explorer®)
- Internal data logging
- Freeze protection
- Low and high superheat alarm
- Low pressure switch function/alarm

ECD-002 Display Unit

- Front panel mounted interface for parameter and status read-out and controller setup via keypad
- Indicator LEDs for valve opening/closing, external ON and alarm

Selection Table

Description	Stand alone		TCP/IP	
	Type	Part No.	Type	Part No.
Superheat Controller for EX4-8 & FX5-9	EC3-X33	807783	EC3-X32	807782
Superheat Controller Kit*	EC3-X33 Contr.Kit	808036	EC3-X32 Contr.Kit	808037
Terminal kit	K03-X33	807645	K03-X32	807644
Superheat Controller for EX4-6	EC3-D73	807804	EC3-D72	807805
Superheat Controller Kit*	EC3-D73 Contr.Kit	808041	EC3-D72 Contr.Kit	808042
Terminal kit	K03-331	807648	K03-331	807648

Note: * Kits contain terminal kit, pressure transmitter PT5-07M with cable assembly, NTC sensor ECN-N60, transformer ECT-623

Selection Table - Accessories

Description		Type	Part No.
Display/keypad unit (opt.)		EC3-X32	807782
Connection cable EC3 to ECD-002	Cable length 1.0 m	ECC-N10	807860
	Cable length 3.0 m	ECC-N30	807861
	Cable length 5.0 m	ECC-N50	807862
Temperature sensor	Cable length 3.0 m	ECN-N30	804496
	Cable length 6.0 m	ECN-N60	804497
	Cable length 12.0 m	ECN-N99	804499
Pressure sensor			
for R22 / R134a / R507 / R404A / R407A / R407C / R407F / R124 / R448A / R449A / R450A / R513A / R1234ze	0.8...7 bar	PT5-07M	802350
		PT5-07T	802370
for R410A	0...18 bar	PT5-18M	802351
		PT5-18T	802371
for R410A / R744	0...30 bar	PT5-30M	802352
		PT5-30T	802382
for R744	0...50 bar	PT5-50M*	802353
Plug and cable assembly for pressure sensor	Cable length 1.5 m	PT4-M15	804803
	Cable length 3.0 m	PT4-M30	804804
	Cable length 6.0 m	PT4-M60	804805
Transformer - 230VAC Input, 24V output, Din rail mounting			
For one set of controller and valve	25 VA	ECT-323	804424
For two sets of controllers and valves	60 VA	ECT-623	804421
Replacement battery kit			807790

Note: *) PT5-50M is not released for use with EXD-D72/D73

Technical Data

EC3

Supply Voltage	24 VAC ±10%, 50/60 Hz
Digital input	24 VAC ±10%, 50-60 Hz 24 VDC ±10%
Power consumption	25 VA max. including connected ECV and display/keyboard
Internal battery charging time	Approximately 2 hours if battery is fully empty
Plug-in connector size	Removable screw version wire size 0.14...1.5 mm ²
Marking	CE
Protection class	IP20 (nach DIN EN60529)
Mounting	DIN rail mounted
Temperature range input	ECN-Nxx: -50...+50°C

ECD-002 Display Unit

Supply	From EC3 Series Controller via connecting cable
LED indicators	Valve opening, valve closing, alarm, demand
Display LED	Numeric segmental display, 2½-digits, red, with automatic decimal point between ±19.9, switchable between °C and °F
Connecting cable	ECC-Nxx or standard CAT5 patch cord with RJ45 connectors
Protection class (DIN EN 60529)	IP65 (mounting in front panel with gasket)
Mounting	Panel mount (71 x 29 mm cutout)

EXD-SH1/2 Controller for EX/CX/FX With ModBus Communication Capability

EXD-SH1/2 are stand-alone universal superheat and or temperature controllers for air conditioning units or refrigeration systems.

Features

- EXD-SH1: Control of one valve
- EXD-SH2: Control of two valves in two independent circuits
- Main function

	Circuit 1	Circuit 2
EXD-SH1	Superheat or Temperature Control	
EXD-SH2	Superheat or Temperature Control	Superheat Control

- Other functions: Limitation of evaporating pressure (MOP), Low pressure switch, freeze protection and manual positioning of valve(s)
- Self-adapting superheat control function in conjunction with Emerson EX4-8 and FX5-9 series
- For multiple refrigerants, including ultralow temperature refrigerant R23 (only with ECN-Z60)
- Modbus (RTU) communication
- EXD-SH2: capability the operation of two evaporator/ EXV / Pressure sensor with single pressure transmitter
- Integrated keyboard with two lines display
- Monitoring of sensors and detection of sensor (ECN/PT5) stepper motor wiring failures
- Optional upload/download key (accessory) for transmission of parameter settings among controllers with the same setting
- Low/high superheat alarm as well as other function alarms
- Electrical connection via plug-in type screw terminals included with controller and Micro Molex EXD-M03 (must be ordered separately)
- DIN rail mounting housing



EXD-SH2



EXD-M03

Selection Table

Type	Description	Part No.	
		Multipack*	Single Pack
Controllers			
EXD-SH1	Controller for Single Refrigeration Circuit	-	807 855
EXD-SH2	Controller for Two Independent Refrigeration Circuits	-	807 856
EXD-M03	Molex Terminal with 3 Meter Wires	-	807 865
ECN-N30	Temperature Sensor with 3 Meter Cable	-	804 496
ECN-N60	Temperature Sensor with 6 Meter Cable	-	804 497
ECN-Z60	Ultralow Temperature Sensor with 6 Meter Cable	-	807 826
Pressure Transmitters: PT5 (7/16-20UNF Connection)			
PT5-07M	Sensing Pressure Range -0.8...7 Bar	802 350M	802 350
PT5-18M	Sensing Pressure Range 0...18 Bar	802 351M	802 351
PT5-30M	Sensing Pressure Range 0...30 Bar	802 352M	802 352
PT5-50M	Sensing Pressure Range 0...50 Bar	802 353M	802 353
PT5-150D	Sensing Pressure Range 0...150 Bar (1/4 NPTF)	802 379M	802 379
Pressure Transmitters: PT5 (Brazing Connection)			
PT5-07T	Sensing Pressure Range -0.8...7 Bar	802 380M	802 380
PT5-18T	Sensing Pressure Range 0...18 Bar	802 381M	802 381
PT5-30T	Sensing Pressure Range 0...30 Bar	802 382M	802 382
PT5-50T	Sensing pressure range 0...50 Bar	802 383M	802 383

Note: Pressure Range 18 Bar for System with R410A, 30 Bar for R410A Economizer, 50/150 Bar for CO₂
*) PT5-xxM: 20 pcs, PT5-xxT: 10 pcs

Accessories

Type	Description	Part No.	
M12 Plug And Cable For Pressure Transmitters PT5		Multipack (20 Pieces)	Single Pack
PT4-M15	1.5 m	804 803M	804 803
PT4-M30	3.0 m	804 804M	804 804
PT4-M60	6.0 m	804 805M	804 805
Uninterruptible Power Supply			
ECP-024	Backup Battery with Two Outputs for Two Controllers	-	804 558
K09-P00	Electrical Terminal Kit for ECP-024	-	804 560
EXD-PM	Super Cap for Only EXD-SH1 (Two Pieces of EXD-PM Required for One EXD-SH2)	-	807 854

Available Configuration Options

	Selectable Valves	
	FX5-9	EX4-8
Refrigerants	R134a, R407C, R410A, R22, R32*	R22, R23, R32*; R124, R134a, R404A, R407C, R407A, R407F, R507, R744
Main Function	Superheat control	Superheat or and temperature control
Pressure Transmitters	PT5, PT6 or 3rd party ratio metric	PT5, PT6 or 3rd party ratio metric

Technical Data: EXD-SH1/2

Supply Voltage	24VAC/DC ±10%, 50/60Hz
Power Consumption	EXD-SH1: Max. 25VA EXD-SH2: Max. 50VA
Terminals 1 to 12	Suitable for 12 Poles Molex Plug
Terminals 13 to 36	Suitable for Removable Screw Version: Wire Size 0.14 ... 1.5mm ² Included in Controller Delivery
Protection Class	IP 00
Marking	

Mounting	DIN Rail Mounted
Accessory (12 Poles Molex Plug with 3 Meter Cable)	Type: EXD-M03 (to be Ordered Separately)

Note: EXD-SH1/2 are not released for flammable refrigerants

Input, Output EXD-SH1/2

Description	Specification
Analogue Input(s): NTC Temperature Sensor Analogue Input: PT1000 Temperature Sensor	ECN-N... (-45 ... +50°C Sensing Range) ECN-Z60 (-80 ... -40°C Sensing Range)
Analogue Input(s): 4...20 mA Pressure Transmitters Analogue Input(s): 0.5...4.5 V Pressure Transmitters	PT5 Third Party Ratio Metric Pressure Transmitters (Total Error: ≤ 1%)
Digital input(s)	Dry Contact, Potential Free
Digital output(s): Alarm Relay(s) Contact is closed: During Alarm Condition Contact is open: During Normal Operation and Supply Power OFF	Resistive Load 24 V AC/DC, Max. 1 A Inductive Load 24 V AC, Max. 0.5 A
Communication	RS485 RTU Modbus, Two Wires

EXD-HP1/2 Stand-alone Superheat/Economizer Controller

EXD-HP1/2 are stand-alone universal superheat and or economizer controllers for heat pumps, heating units, air conditioning and precision cooling such as telecom and shelter applications.

Features EXD-HP1/2

- Self adapting superheat/economizer control in conjunction with EMERSON stepper motor driven electronic expansion Valves EXM/EXL
- Discharge hot gas temperature control by liquid/vapor injection to compressor
- EXD-HP1: Controller with one EXV output
- EXD-HP2: Controller with two independent EXV outputs
- Controllers as slave with Modbus (RTU) communication capability. All data (read/write) accessible by any third party controller having modbus communication (RTU)
- Upload/download key (accessory) for transmission of parameter settings among controllers with the same setting
- Low pressure switch and freeze protection function
- Manual positioning of valve(s)
- Limitation of evaporating pressure (MOP)
- Low/high superheat alarm
- Monitoring of sensors and sensor wiring / detection of sensor and wiring failures
- Integrated display (3-digit LEDs) and keyboard
- Electrical connection via plug-in type screw terminals (included with controller)
- DIN rail mounting housing



EXD-HP2

Selection Table

Type	Description	Part No.	
		Multipack	Single pack
Controllers			
EXD-HP1	with 1 EXV output	807836M	807836 - HP1
EXD-HP2	with 2 EXV outputs	807837M	807837 - HP2
Valves / Coils			
EXM-B0A	Electronic expansion valve	800399M	-
EXM-B0B		800400M	-
EXM-B0D		800401M	-
EXM-B0E		800402M	-
EXM-125	Coil 12 VDC	800403M	-
EXL-B1F	Electronic expansion valve	800405M	-
EXL-B1G		800406M	-
EXL-125	Coil 12 VDC	800407M	-
Temperature sensor			
ECP-P30	Temperature sensor with 3 m cable	-	804495
Pressure sensors Suction pressure (Refrigerant)			
PT5-07M/PT5-07T	-0.8...7 bar (R22, R134a, R407C)	802350M / 802370M	802350 / 802370
PT5-18M/PT5-18T	0 ... 18 bar (R410A, R32 /suction pressure)	802351M / 802371M	802351 / 802371
PT5-30M/PT5-30T	0 ...30 bar (R410A, R32 / Intermediate pressure)	802352M / 802382M	802352 / 802382
Plug and cable assembly for pressure sensors			
PT4-M15	1.5 m cable length	804803M	804803
PT4-0	3.0 m cable length	804804M	804804
ECT-323	Transformer 25VA	-	804424

Application as Air to Water Heat Pumps: Heating and Cooling (Package System With Economizer)

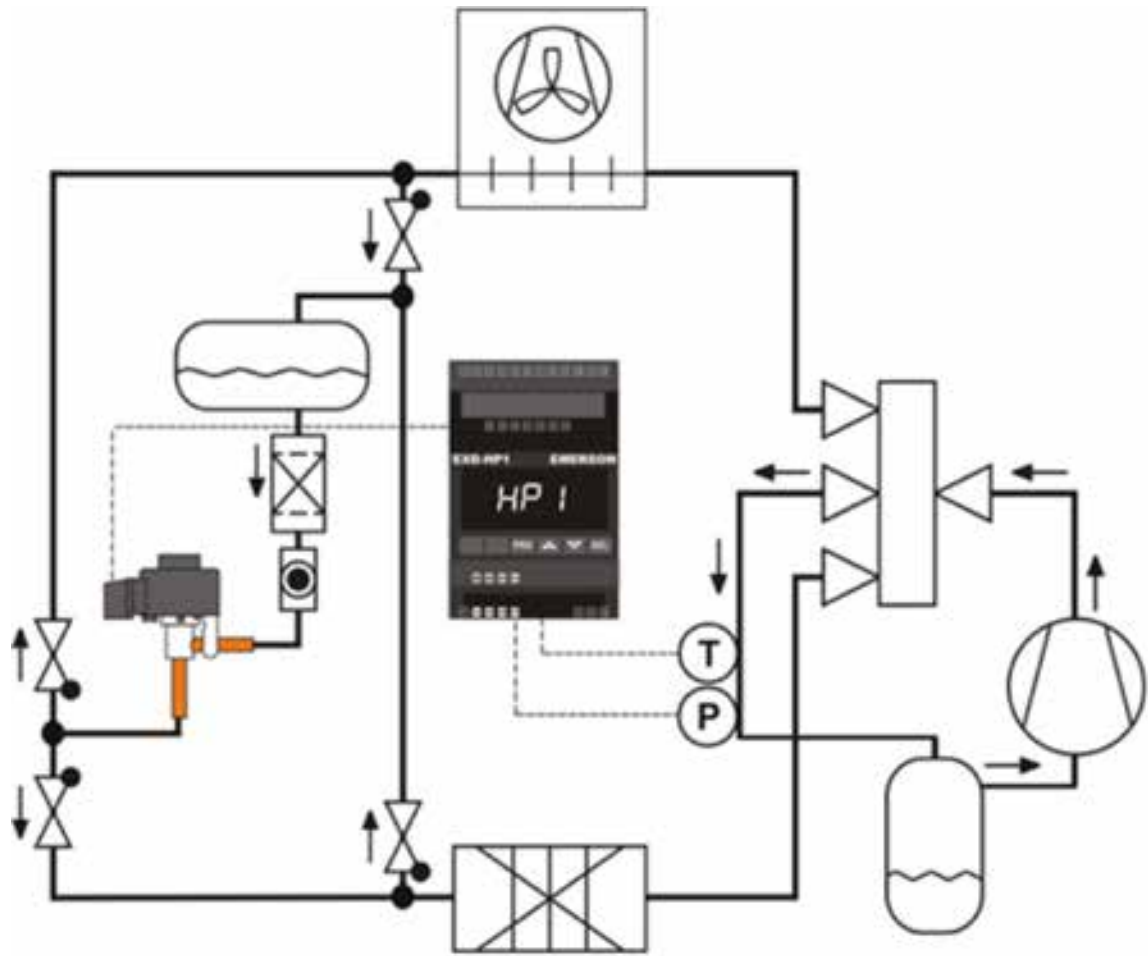

Technical Data

Supply voltage	24 VAC/DC $\pm 10\%$
Power consumption	EXD-HP1: Max. 15 VA EXD-HP2: Max. 20 VA
Digital inputs	EXD-HP1: Two, each potential free EXD-HP2: Three each potential free
Relay output	SPDT contacts, AgSnO Inductive (AC15) 24 VAC : 1 A Resistive: 24 VAC/DC: 4 A
Plug-in connector size	Removable screw version wire size 0.14...1.5 mm ²
Protection Class	IP 20
Mounting	DIN Rail Mounted
Marking	CE

Input Sensors, Output Valves

Description	Specification
Temperature Input	ECP-P30 (3 meter cable length) Range: -30°C...+150°C
Pressure Sensor Input	PT5 Signal: 4 ... 20 mA

EXD-TEVI Economizer Controller for Tandem Compressors

EXD-TEVI is a stand-alone controller for enhanced wet vapor injection for Copeland Scroll™ tandem compressors in heating applications.

Features EXD-TEVI

- Emerson solution for specified operating map of tandem scroll
- Two EXL valves can be driven in parallel for required wide injection capacity
- Input signals: Injection (intermediate) pressure and temperature sensor as well as two compressor discharge temperature sensors
- Two independent digital inputs for recognition of tandem compressors operation
- High discharge temperature alarm
- Monitoring of sensors and sensor wiring and detection of sensor wiring failures
- Controllers as slave with Modbus (RTU) communication capability
- Upload/download key (accessory) allows to copy parameter settings from one controller to others
- Integrated 3¹/₂ digit 7-segment display with 6 indicator LEDs
- Electrical connection via plug-in type screw terminals (included with controller)



EXD-TEVI

Selection Table

Type	Description	Part No.	
		Multipack	Single pack
Controller			
EXD-TEVI	Controller with connectors	807838M	807838
Temperature Sensors: ECN			
ECN-N30	Temperature sensor with 3 m cable	-	804496
ECN-N60	Temperature sensor with 6 m cable	-	804497
Pressure transmitters: PT5			
PT5-30M	Sensing pressure range 0...30 bar (7/16-20UNF connection)	802352M	802352
PT5-30T	Sensing pressure range 0...30 bar (Brazing connection)	802382M	802382
Plug and cable assembly for pressure transmitters			
PT4-M15	1.5 m cable	804803M	804803
PT4-M30	3 m cable	804804M	804804
Electronic expansion valve with coils			
EXL-B1F	Valve body	800405M	-
EXL-B1G		800406M	-
EXL-125	coil for EXL 12VDC	800407M	-

Technical Data

Supply Voltage	24VAC/DC ±10%
Power Consumption	EXD-TEVI: Max. 20 VA
Digital Inputs	2 (Potential Free)
Relay Output (Alarm)	SPDT, with AgSnO Contacts Inductive (AC15) 24V AC: 1 A Resistive: 24 V AC/DC: 4 A
Plug-In Connector Size	Removable Screw Version Wire Size 0.14 ... 1.5mm ²

Protection Class	IP 20
Mounting	DIN Rail Mounted
Marking	CE

Technical Data: Sensors

Description	Specification
Temperature Sensors	1 x 10k NTC for Injection Line Temperature (ECN-N30 / ECN-N60) 2 x 86k NTC for Discharge Gas Temperature (Part of Compressor Delivery)
Pressure Transmitter EVI	PT5-30M/T: 4...20 mA (Range: 0...30 Bar)

Universal Driver Modules Series EXD-U01

Stepper motor valve driver specifically designed for the Emerson EX and CX Series of electrical control valves in applications such as:

- Capacity control by means of hot gas bypass
- Evaporating pressure regulator or crankcase pressure regulator
- Hot gas flow such as heat reclaim
- Condensing pressure regulation and liquid duty
- Refrigerant mass flow control in CO₂ transcritical systems

Features

- Plug and play, no parameter setting
- Valve opening proportional to 4...20mA or 0...10V analogue input signal
- Digital input can be used to force valve closing
- Easy configurable by Dip-switches
- Easy wiring
- Fully tested and ready for operation



EXD-U01

Options

- Uninterruptible Power Supply ECP-024 to automatically close valve after power down

Selection Table

Type	Part No.	Description
EXD-U01	804750	Universal Driver Module
EXD-U01 Contr. Kit	808052	Universal Driver Module with Terminal Kit
K09-U00	804559	Terminal Kit for EXD-U01

* Controller Kit contains terminal kit

Accessories

Type	Part No.	Description
ECP-024	804558	Uninterruptible power supply for up to 2 drive modules
K09-P00	804560	Electrical terminal kit for ECP-024
ECT-323	804424	Transformer 25VA
ECT-623	804421	Transformer 60 VA 24V/230V AC – DIN-rail mounting



K09-U00



ECP-024



ECP-024



ECT-323



ECT-323

Function

The driver module EXD-U01 requires an analog input signal of 4...20 mA or 0...10 V. The output is the closing/opening of EX/CX valve series and consequently the control of liquid or vapor refrigerant mass flow in accordance with the analog input. The universal driver module can be connected to any controller which can provide a 4...20 mA or 0...10 V analog signal. This gives extreme flexibility to system manufacturers to use any desired controller and achieve different functionalities. The universal driver module keeps the valve at fully close position when the input signal is 4 mA or 0 V. The valve will be fully open at 20 mA or 10 V.

Optional uninterruptible power supply ECP-024

The optional uninterruptible power supply ECP-024 contains a rechargeable lead-acid battery, which provides enough energy to close the valve in case of power loss. ECP-024 can be connected to two EXD-U01 Driver Modules for closure of up to two valves.

Technical Data

Supply Voltage	24 VAC ±10%, 50-60 Hz Note: 24 VDC supply voltage can be used but it results to lower MOPD and it needs to be verified by system manufacture.
Supply current	to be protected by a 1.0 A external fuse
Power consumption	10 VA in conjunction with EXV
Protection Class	IP20
Weight	~ 800 g
Marking	

Analog input signal Burden	4-20 mA 364 Ω
Analog input signal	0-10 V
Impedance	27 kΩ
Digital input	24 VAC ±10%, 50-60 Hz 24 VDC ±10%
Connector	Screw terminals for wire size 0.5-2.5 mm ²
Mounting	DIN rail mounted
Housing	Aluminum

Optional Uninterruptible Power Supply ECP-024

Backup battery type	Lead acid gel rechargeable battery
Number of backup batteries	2, each 12 VDC, 0.8 Ah
Supply voltage	24 VAC ±10%, 50-60Hz
Output voltage, UB	18 VDC
Number of outputs to drivers	2
Marking	

Connection	Screw terminals for wire size 0.5-2.5 mm ²
Mounting	DIN rail mounted
Protection class	IP20
Housing	Aluminum

Condensing Unit Controllers Series EC2 With Web Server Function and TCP/IP Interface

Features

- Maintenance and alarm management
- Sensor failure handling
- Inputs for common low and common high pressure alarms
- Configuration data stored in non-volatile memory
- Electrical connection via plug-in type screw terminals
- Web Server Function and TCP/IP Interface (see beginning of this chapter)
- Operation and commissioning via local or remote PC
- CE marking



EC2 Controller

Condensing Unit Controllers

- To control a combination of compressors and condenser fans based on suction and condensing pressure respectively
- Control of Copeland Scroll Digital™ Compressors



K02-211



ECT-323

Communication TCP/IP Ethernet

- Web Server Function provides monitoring and configuration through a standard Web browser. Ethernet interface, as used in most office PCs
- Graphical visualization via built-in Web pages
- Fixed or dynamic TCP/IP address with username and password
- Up to 30 days datalog
- Multiple language support (see www.emersonclimate.eu)



PT5

PT4-Mxx

Selection Table

Type	Description	Part No.
Condensing Unit Controller		
EC2-552	Condensing Unit Controller for two compressors or one Digital Scroll and one single stage compressor, variable fan speed control	807738
EC2-552 Contr. Kit	Condensing Unit Controller Kit with Terminal Kit K02-540, Pressure transmitter PT5-07M & PT5-30M with cable assembly, transformer ECT-323 with 25VA	808019
Terminal Kits and Cables		
K02-540	Terminal Kit for EC2-552	800070
ECX-N60	Ethernet Cable (TCP/IP)	6.0 m length 804422
Pressure Transmitter		
PT5-07M	- 0.8...7 bar	802350
PT5-18M	0...18 bar	802351
PT5-30M	0...30 bar	802352
PT5-50M	0...50 bar	802353
PT4-M15	Cable Assembly for PT5	1.5 m cable length 804803
PT4-M30		3 m cable length 804804
PT4-M60		6 m cable length 804805
Transformers		
ECT-323	Transformer Class II – 230 VAC Input, 24 V output, 25 VA	804424

Block Diagrams

EC2-552 Condensing Unit Controller for 2 single stage compressors or 1 Digital Scroll and 1 single stage compressor

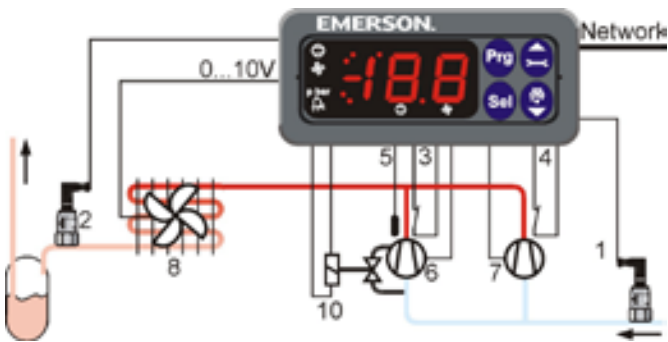

Inputs

- 1 = Suction Pressure
- 2 = Condenser Pressure
- 3 = Safety Switch Comp 1
- 4 = Safety Switch Comp 2
- 5 = Temperature Input

Outputs

- 6 = Digital Scroll Compressor
- 7 = Single Stage Compressor
- 8 = Speed Controlled Fan with EC-Motor
- 10 = PWM Digital Scroll Solenoid Valve

Coldroom Controller Series EC3 Temperature and Superheat Control of EX4-8 (Stepper Motor)

Features

- Superheat control with self-adapting algorithm for Stepper Motor driven ECVs (EX4-8)
- Thermostat, fan & defrost control
- Limitation of evaporating temperature (MOP)
- Analog inputs: 3 NTC temperature sensors
- With integral backup battery to close Control Valve in case of power loss
- Analog input for suction pressure measurement using Emerson PT5 Series pressure transmitters
- Digital inputs for compressor safety and coldroom door contact
- Relay outputs for compressor, defrost and alarm plus programmable relay
- All parameters and functions are programmable:
 - via TCP/IP Ethernet controller (EC3-332)
 - with keypad of optional display unit ECD-001
- Electrical connections via plug-in type screw terminals
- Lightweight aluminum enclosure for DIN rail mounting
- Multiple language support (see www.emersonclimate.eu)
- CE marking
- IP20 protection class



EC3-332

ECD-001

Communication TCP/IP Ethernet

- Web Server Function provides monitoring and configuration through a standard Web browser. Ethernet interface, as used in most office PCs
- Graphical visualization via built-in Web pages
- Fixed or dynamic TCP/IP address with username and password
- Up to 30 days datalog
- Multiple language support (see www.emersonclimate.eu)

Features of ECD-001 Display Unit

- For various system temperatures and valve opening readout
- Connection to EC3 Series via a RJ45 Western Digital plug. No further power cables required
- 2 1/2 digit display
- Indicator LEDs for compressor, fan, heater and alarm
- 4 keys allow parameter modification
- Easy mounting in panels with 71 x 29 mm cutout
- IP65 if mounted in front panel

Selection Table

Type	Description		Part No.
Condensing Unit Controller			
EC2-332	Coldroom Controller EXV Stepper Motor drive		807632
EC2-332 Contr. Kit	Coldroom Controller Kit with Terminal Kit K02-540, Pressure transmitter PT5-07M & PT5-30M with cable assembly, transformer ECT-323 25VA		808013
Terminal Kits and Cables			
K03-331	Terminal Kit for EC2-332		800648
ECX-N50	Ethernet Cable (TCP/IP)	6 m length	804422
Display Unit			
ECD-001	ECN-S30		807641
ECC-N10	Connection cable EC3 to ECD	1 m cable length	807860
ECC-N30		3 m cable length	807861
ECC-N50		5 m cable length	807862
Temperature Sensors			
ECN-S15	NTC Sensors - Air type, (10 kΩ at 25°C)	1.5 m cable length	804304
ECN-S30		3 m cable length	804305
ECN-S60		6 m cable length	804284
ECN-N30	NTC Sensors - Pipe type, (10 kΩ at 25°C)	3 m cable length	804496
ECN-N60		6 m cable length	804497
ECN-N99		12 m cable length	804499
ECN-F60	NTC Sensors - Fin type, (10 kΩ at 25°C)	6 m cable length	804283
Pressure Transmitter			
PT5-07M	- 0.8...7 bar		
PT5-18M	0...18 bar		
PT4-M15	Cable Assembly for PT5	1.5 m cable length	804803
PT4-M30		3 m cable length	804804
PT4-M60		6 m cable length	804805
Transformers			
ECT-323	Transformer Class II – 230 VAC Input, 24 V Output, 25 VA		804424
ECT-623	Transformer Class II – 230 VAC Input, 24 v Output, 60 VA (only EX8)		804421

Compressor Soft Starter CSS-25U / CSS-32U

The Compressor Soft Starter CSS-25U / CSS-32U is used for switching, protecting and starting current limitation of single phase compressors in residential heat pump applications.

Features

- For motors with maximum operating current up to 25A/32A
- Limitation of starting current to less than 45 A (Part No. 805209 less than 30 A)
- Self-adjusting for use in 50 Hz or 60 Hz supply
- Self-adjusting to motor current - no manual adjustment or calibration necessary
- Alarm relay output
- Start capacitor for improved motor acceleration is switched off after start
- Low voltage shutdown
- Locked rotor recognition and shutdown
- Delay function to limit number of motor starts per hour
- Thyristor protected contactor for long life
- No extra motor contactor needed
- Self-diagnostics
- Mounting clip for easy installation allows DIN rail mounting in two directions
- Easy connection by cage type screw terminals wire Ø 4mm



CSS-32W

CE Standards:

- LVD 2006/95/EC Low Voltage Directive
- EN 60947-1 Low voltage switchgear and controlgear
- EN 60947-4-2 Contactors and motor-starters - AC semiconductor motor controllers and starters
- EN 60335-1, EN 60335-2-40: Safety of household and similar electrical appliances (PCN 805 204 and 805 205 only, confirmed and certified by independent test lab VDE.)
- EMC 2004/108/EC
- ROHS 2011/65/EU

Selection Table

Type	Part No.	Part No. (20 Pieces)	Description	I max
CSS-32U	805 204	805 204 M	Soft Starter Incl. Mounting Clip, VDE Released Version	32A
CSS-25U	805 205	805 205M	Soft Starter Incl. Mounting Clip, VDE Released Version	25A
CSS-25U	805 209	805 209M	Soft Starter Incl. Mounting Clip (Limitation of Starting Current to Less Than 30 A)	25A
K00-003	807 663	-	3-pol Screw Connector to Alarm Output for Wires Up to 2.5mm ² ; Bag with 50 Pieces	

Technical Data

Operating Voltage	230 V 50/60 Hz Nominal
Nominal Compressor Current	CSS-32U: 32A Max. CSS-25U: 25A Max.
Maximum Start Current	CSS-32U: 45A CSS-25U (805 205): 45A CSS-25U (805 209): 30A
Operating Temperature	-20 ... +55°C Non Condensing
Storage Temperature	-20 ... +65°C Non Condensing
Start Capacitor	200 ... 240 µF
Time Delay After Stop	0.5 ... 5 Min

Alarm Relay, AgNi (SPDT)	250V~ / 3A 30V= / 3A
Resistive (AC1) Max.	
Flexible Cable Cross Section	
CSS-32U/-25U All Terminals	0.25 ... 4 mm
Flexible Cable Cross Section	
Alarm Output Connector K00-003	0.25 ... 2.5 mm
Max. Vibration (At 10 ... 1000 Hz)	4 g
Weight	430 g
Protection Acc. IEC 529	IP 20

Wiring Diagram

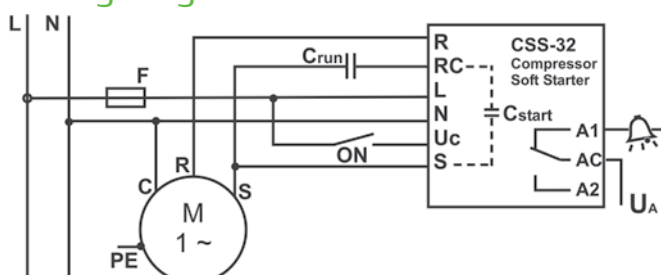

CSS Contacts

- R = Output Motor Run Winding
- RC = Output Run Capacitor
- L = 230V / AC Power Input
- N = Neutral Line
- Uc = Start Input (ON if Connected to 230V)
- S = Output Start Winding from Start Capacitor
- A1, AC, A2 = Alarm Relay Contact

Pressure Transmitter PT5

PT5 Pressure Transmitters convert a pressure into a linear electrical 4..20 mA output signal suitable for controlling simple compressor and fan switching to the more sophisticated application of superheat modulation of Electronic Control Valves.

With competitive performance to price characteristics and an easy to install pre-fabricated M12 cable assembly, PT5 transmitters are the designers choice for all heat pump, refrigeration and air conditioning applications.

Features

- Piezo-resistive sensor with output signal 4...20 mA and 2-wire connection for the precise operation of superheat, compressor or fan control systems
- Specially calibrated pressure ranges with $\pm 1\%$ accuracy performance to fulfill demands of today's refrigeration and HVAC applications
- Fully hermetic
- PT5-xxM with 7/16"-20UNF pressure connection and Schrader valve opener
- PT5-xxT with 40 mm stainless steel tube and integrated brazing neck for easy mounting in applications requiring a fully hermetic system solution
- PT5-150D for subcritical and transcritical CO₂ systems
- Vibration, shock and pulsation resistant
- Protection class IP65 / IP67 (type-specific)
- UL (File No. E258370)



PT5-xxM
with PT4-Mxx Cable Assembly



PT5-150D



PT5-xxT

Selection Table

Type	Part No.		Pressure Range For Signal Output (Bar)*	Output Signal	Medium Temp. Range at Pressure Connection (°C)	Ps: Max. Working Pressure (Bar)*	Pt: Test Pressure (Bar)*	Burst Pressure (Bar)*	Pressure Connection
	Single Pack	Multi-Pack**							
PT5-07M	802 350	802 350M	-0.8 .. 7	4 .. 20 mA	-40 .. +100	27	30	150	7/16" – 20 UNF (with Schrader Valve Opener)
PT5-18M	802 351	802 351M	0 .. 18			50	63	250	
PT5-30M	802 352	802 352M	0 .. 30			60	100	400	
PT5-50M	802 353	802 353M	0 .. 50			100	150	400	
PT5-07T	802 380	802 380M	-0.8 .. 7		-40 .. +135	27	30	150	6 mm ODM
PT5-18T	802 381	802 381M	0 .. 18			50	63	250	
PT5-30T	802 382	802 382M	0 .. 30			60	100	400	
PT5-50T	802 383	802 383M	0 .. 50			100	150	400	
PT5-150D	802 379	-	0 .. 150	-40 .. +100	220	320	1000	1/4" NPT (male)	

*) Sealed Gauge Pressure

**) PT5xxM: 20 Pcs, PT5-xxT: 10 Pcs

Selection Table Plug/Cable Assemblies: Assembly Fits All Models

Type	Part No.		Cable Length	Weight (g/Piece)	Temperature Range
	Single Pack	Multi Pack*			
PT4-M15	804 803	804 803M	1.5 m	50	-50 ... +80°C Static Application -25 ... +80°C Mobile Application
PT4-M30	804 804	804 804M	3.0 m	80	
PT4-M60	804 805	804 805M	6.0 m	140	

Note: *) 20 pieces

Technical Data Pressure Transmitter

Supply Voltage (Polarity Protected)	Nominal: 24VDC Range: 7..30VDC PT5-150D: 7 .. 26.4VDC
Permissible Noise & Ripple Influence of Supply Voltage	< 1 Vp-p < 0.02 %FS/V
Operating Current	Maximum ≤ 24 mA 4...20 mA Output
Load Resistance	$R_L \leq \frac{U_b - 7.0V}{0.02A}$
Response Time	≤ 5 ms
Temperatures Transport and Storage Operating Ambient Housing Medium: PT5-xxM, -150D PT5-xxT	-25 .. +80 °C -40 .. +80 °C -40 .. +100 °C -40 .. +135 °C (UL listed -40...+100°C)

Sensor Lifetime	30 Million Load Cycles with 1.3 Times of Nominal Pressure
Electrical Connection PT4-Mxx Cable Assembly	M12 Connection According to EN61076-2-101 Part 2 Prefabricated, Various Cable Lengths
Approvals/Marking	CE: 2004/108/EEC, EN 61326 Emission (Group 1; Class B) and Immunity (Industrial Locations) UL, cRUus (UL File Nr. E258370)
Protection Class (EN 60529)	PT5-07, -18: IP65 with Plug PT5-30, -50, -150: IP67 with Plug
Materials Housing, Pressure Connector and Diaphragm with Medium Contact	Stainless Steel 316L, 1.4534 1.4301 (PT5-xxT)
Electrical Connector	Highly Resistive, Fiberglass-Enforced Plastic PBTGF30

Accuracy Performance

Type	Total Error *	Temperature Range
PT5-07 / 18	±1% FS	-40 ... +20 °C
PT5-30 / -50/	±1% FS ±2% FS	+10 ... +50 °C -10 ... +80 °C
PT5-150D	±1% FS ±2% FS	+10 ... +50 °C -10 ... +100 °C

*) Total Error Includes Non-Linearity, Hysteresis, Repeatability As Well As Offset And Span Drift Due To The Temperature Changes.
Note: % FS is Related to Percentage of Full sensor Scale.

Electronic Fan Speed Controller Series FSY/FSM

Electronic Speed Controllers FSY / FSM control the speed of fan motors depending on pressure.

Features

- Adjustable pressure for cut-off
- High Voltage Triac (800 Volts)
- Integrated protection circuit against voltage peaks
- Compact design
- Easy mounting and adjustment
- Easy retrofit in existing systems
- No additional gasket required (completely molded into plug)
- Multi-position plug with EMC filter cable for flexible installation
- **CE** per 14/30/EU (together with FSF cable)
- UL file E183816
- Other pressure connection upon request (minimum order volume 100 pieces)



FSY-43S

Selection Table

Type	Part No.	Pressure range * (bar)	Factory-setting * (bar)	Factory Setting * Bar	Max. operating Pressure PS (bar)	Test Pressure PT (bar)	Pressure connection
Fan Speed Controllers With Cut-off Mode							
FSY-41S	0715533	4.0...12.5	8.0	27	30	30	7/16"-20 UNF female
FSY-42S	0715534	9.2...21.2	15.0	32	36	36	
FSY-43S	0715537	12.4...28.4	21.8	43	48	50	
Fan Speed Controllers With Min. Speed Mode							
FSM-41S	0715520	4.0...2.5	8.0	27	30	30	7/16"-20 UNF female
FSM-42S	0715521	9.2...21.2	15.0	32	36	36	
FSM-43S	0715522	12.4...28.4	21.8	43	48	50	

Note: *) Pressure at which fan is switched off (FSY) or at which fan is running with minimum speed (FSM)

Cable Assemblies With Plug and EMC Filter

Type	Part No.	Temperature Range (°C)	Cable Length (m)
FSF-N15	804640	Temperature Range: -50...+80°C	Cable length 1.5 m
FSF-N30	804641		Cable length 3.0 m
FSF-N60	804642		Cable length 6.0 m
Seal Ring Pack	803780	Copper Gaskets 100 pcs	

Technical Data

Supply Voltage	230VAC, +15%, -20%, 50/60 Hz
Nominal Current (See Diagram Below)	0.1 ... 4 (3) A
Starting Current	Max. 8 Amps/5 Sec.
Medium Compatibility	HFC, HCFC, HFO/HFO Blends (Not Released for Use with Inflammable Refrigerants)
Protection Class According to IEC529 /EN 60529	IP 65 (with Fitted Connectors FSF-xxx)
Temperature Ranges °C Ambient	-20...+55°C (>40°C See Diagramm)
Storage & Transportation Medium	-30...+70°C -20...+70°C

Max. Current vs Ambient Temperature

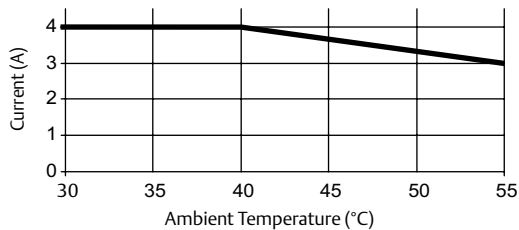

Pressure Change Per Turn of Adjustment Screw	FSY-41: 4.0 .. 12.5 Bar Clockwise ~ +1.2 Bar Counterclockwise ~ -1.2 bar
	FSY-42: 9.2 .. 21.2 Bar Clockwise ~ +2.5 Bar Counterclockwise ~ -2.5 Bar
	FSY-43: 12.4 .. 28.4 Bar Clockwise ~ +3.3 Bar Counterclockwise ~ -3.3 Bar
Proportional Range	FSY-41: 2.5 Bar FSY-42: 3.8 Bar FSY-43: 4.6 Bar
Housing Material	PC and PA

Function Diagram

The control behaviour can be easily described by looking at the function of output voltage versus input pressure: In the maximum range the FSY provides a constant output voltage of approximately 1% below the supply voltage. The fan is running at maximum speed. Along the proportional range, the output voltage varies between maximum and minimum voltage of approximately 50% of the supply voltage. This causes the fan to slow down from maximum to minimum speed.

Further decrease of pressure in the minimum range leads to cut-off of the fan motor. Reincrease of input pressure will start the motor with a hysteresis of approximately 0.7 bar to avoid cycling. The pressure from which motor cuts off is adjustable (see selection table - adjustment range).

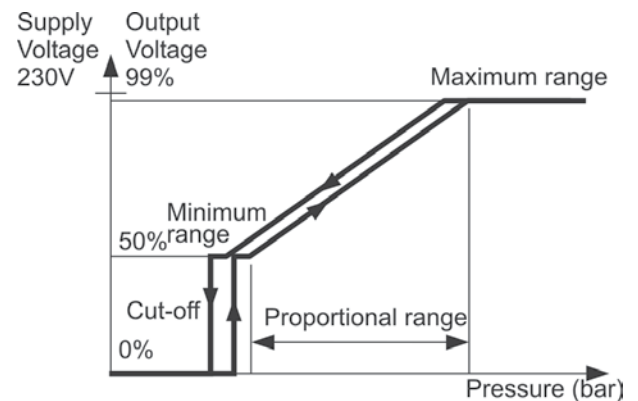

FSE Fan Speed Control Module

Electronic Fan Speed Control Modules FSE generate a 0...10 V signal, which is used to control the speed of condenser fan motors in commercial refrigeration and air-conditioning systems. Ideal for use with high efficient EC-motors, but can be also used with phase cut controllers for induction motors.

Features

- Energy saving due to improved cooling efficiency
- Pressure for minimum speed adjustable
- Small proportional band and large hysteresis to minimize cycling at small pressure changes
- Reduced fan noise level during low ambient temp. conditions
- Improved overall performance of cooling system
- Easy installation with cables for power supply and motor connection factory wired
- IP 65 protection for outdoor mounting suitable for any size of EC fan motors
- UL file nr.: E355325 (Released for 43 bar)



FSE Control Modules

Selection Chart Control Modules FSE

Type	Part No.	Refrigerants	Adjustment Range PCut (bar) *	Factory settings (bar)	Max. Operating Pressure PS (bar)	PT (bar)	Pressure Connection
FSE-01S	804 701	R134a	4 ... 12.5	7.8	27 bar	30 bar	7/16" -20 UNF female
FSE-02S	804 706	R22, R407C, R404A, R507	10 ... 21	15.5	32 bar	36 bar	7/16" -20 UNF female
FSE-03S	804 711	R410A	12 ... 28	20.4	45 bar	50 bar	7/16" -20 UNF female

Cable Assemblies for Connection of FSE Control Module to Controller

Type	Part No.	No of Leads	Diameter of Leads	Temperature Range °C	Cable Length (m)
PS3-N15	804 580	3	0.75 mm ²	-25...+80	1.5
PS3-N30	804 581				3.0
PS3-N60	804 582				6.0

Technical Data FSE

Supply Voltage	10 V; Applied by Controller
Operating Current 0...10 VDC Output	Max. 1 mA
Medium Compatibility	HFC, HCFC, HFO/HFO Blends, POE-, Synthetic and Mineral Oils
Protection Class (IEC529/EN 60529)	IP 65 with Cable Connector Assemblies PS3-Nxx

Pressure Connection FSE-01S and FSE-02S FSE-03S	Brass Stainless Steel
Temperature Range Storage and Transportation Operation	-30° ... +70°C -20° ... +65°C
Materials Housing Cover	PA





Thermo™ - Expansion Valves

Basic Terms and Technical Information

Operating Principles

Alco Thermo-Expansion valves control the superheat of refrigerant vapor at the outlet of the evaporator. They act as a throttle device between the high pressure and the low pressure sides of refrigeration systems and ensure that the rate of refrigerant flow into the evaporator exactly matches the rate of evaporation of liquid refrigerant in the evaporator. Thus the evaporator is fully utilized and no liquid refrigerant may reach the compressor.

Description of Bulb Charges

The application ranges of Thermo-Expansion valves are heavily influenced by the charge selected.

Liquid Charges

The behaviour of Thermo-Expansion valves with liquid charges is exclusively determined by temperature changes at the bulb and not subject to any cross-ambient interference. They feature a fast response time and thus react quickly in the control circuit. Liquid charges cannot incorporate MOP functions. Maximum bulb temperatures shall not exceed 75°C.

Gas Charges

The behaviour of Thermo-Expansion valves with gas charges will be determined by the lowest temperature at any part of the expansion valve (power assembly, capillary tube or bulb). If any parts other than the bulb are subject to the lowest temperature, malfunction of the expansion valve may occur (i.e., erratic low pressure or excessive superheat). Alco Thermo-Expansion valves with gas charges always feature MOP functions and include ballasted bulbs. Ballast in the bulb leads to slow opening and fast closure of the valve. Maximum bulb temperature is 120°C.

Adsorption Charges

These charges feature control characteristics much like MOP charges but avoid the difficulties of cross-ambient interference. Response time is slow but perfectly suitable for common refrigeration systems. Maximum bulb temperature is 130°C.

MOP (Maximum Operating Pressure)

MOP functionality is somewhat similar to the application of a crankcase pressure regulator. Evaporator pressures are limited to a maximum value to protect compressor from overload conditions. MOP selection should be within maximum allowed low pressure rating of the compressor and should be at approximately 3K above evaporating temperatures.

Practical hint: Superheat adjustments influence the MOP:

Increase of superheat:	Decrease of MOP
Decrease of superheat:	Increase of MOP

Static Superheat

Alco Thermo-Expansion valves are factory preset for optimum superheat settings. This setting should be modified only if absolutely necessary. The readjustment should be at the lowest expected evaporating temperature.



Subcooling

Subcooling generally increases the capacity of the refrigeration system and may be accounted for when dimensioning an expansion valve by applying the correction factor K_c . The capacity corrections for evaporating temperature, condensing temperature and subcooling are all incorporated in K_c . These are, in particular the liquid density upstream from the expansion valve, the different enthalpies of liquid and vapor phase refrigerants, as well as certain parts of flash gas after expansion. The percentage of flash gas differs with various refrigerants and depends on system conditions.

Heavy subcooling results in very small flash gas amounts and therefore increases expansion valve capacities. These conditions are not covered by K_c . Likewise, small flash gas amounts lead to reduced evaporator capacities and may result in substantial discrepancies between the capacities of the Thermo-expansion valve and the evaporator. These effects have been integrated in selection program "Controls Navigator".

Dimensioning

To facilitate valve dimensioning for other than standard conditions, Emerson Climate Technologies offers the "Controls Navigator" selection tool which can be downloaded from www.emersonclimate.eu

See www.emersonclimate.eu for contact addresses, email, phone numbers or downloads.

Dimensioning of Thermo™ - Expansion Valves for Systems With Refrigerant Having Temperature Glide

As opposed to single substances (e.g. R 134a) where the phase change takes place at a constant temperature/pressure the evaporation and condensation of zeotropic blends are in a "gliding" form (e.g. at a constant pressure the temperature varies within a certain range) through evaporators and condensers. HFO blends R448A and R449A are zeotropic blends.

The condensing /evaporating pressure must be determined at saturated temperatures (bubble for liquid / dew points for vapor) for dimensioning of the expansion valves, solenoid valves etc. The corresponding dew point for liquid pressures is provided in case of compressor selection based on dew point of liquid pressure.

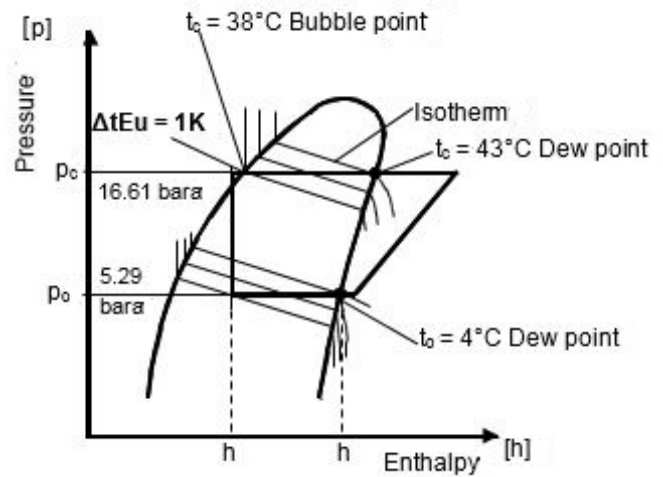

Selection Guide for Expansion Valves

Series	Selection Criteria			
	Capacity Range R448A (kW)	Evaporating Temp. Range (°C)	Main Application	Features
TI	0.5...19.4	+20...-45	Refrig./Air Cond. Heat Pumps	Exchangeable Orifices
TX3	0.8...15.0	+20...-45	Refrig./Air Cond. Heat Pumps	Hermetic, Superheat Adjustable, Optional with Check Valve
TX7	32...183 (R401A)	+20...-45	Air-Cond. Heat Pumps	Hermetic, Superheat Adjustable
T	1.9.. 301	+30...-45	Refrig./Air Cond. Heat Pumps	Exchangeable Orifices, Power-Assembly and Flange
ZZ	1.7...24.7	-45...-120	Low Temperature Application	Exchangeable Orifices, Power-Assembly and Flange
L	1.9...222	+30...-50	Liquid Injection Superheat Control	Exchangeable Orifices, Power-Assembly and Flange
935	5.2...59.8	+30...-45	Liquid Injection Temperature Control	Exchangeable Orifices, Power-Assembly and Flange

Thermo™ - Expansion Valves Series TI

Exchangeable Orifices

Features

- Laser-welded diaphragm / power element with large diameter for high reliability and maximum lifetime
- Constant superheat across wide application ranges
- Easy and precise superheat setting by internal fine threads
- Three styles of connections:
 - TILE: Stainless steel brazed fittings eliminate the need of wet rags during brazing
 - TIS(E): Copper brazed fittings (valve requires wet rag during brazing)
 - TI(E): Flare
- With capacities between 0.5kw and 19.4 kW (R448A) ideally suited for service work
- Internal or external equaliser
- Cleanable / exchangeable inlet strainer in orifice assembly
- Inlet brazing adapter
- Capillary tube length 1.5 m
- Max. working pressure PS: 45 bar
- Temperature range TS: -45...+75°C
- PS: 45 bar. TS: -45 ... +75°C
- CE Marking acc. PED not required

Type Code

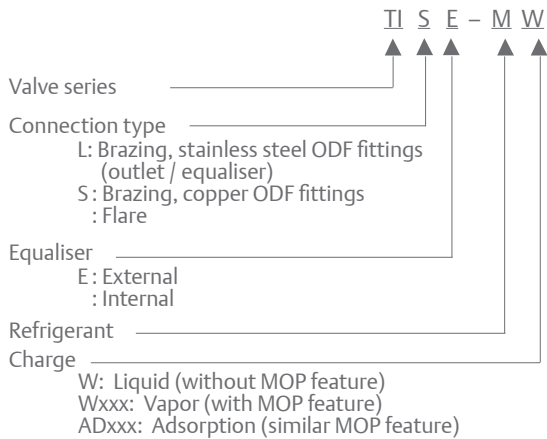

TILE



TIE

Selection Table for Orifice Assembly With Strainer for Inlet Connection

Type	Nominal Capacity* (kW)							
	TIO-00X	TIO-000	TIO-001	TIO-002	TIO-003	TIO-004	TIO-005	TIO-006
Part No.	800 532	800 533	800 534	800 535	800 536	800 537	800 538	800 539
R134a	0.3	0.8	1.9	3.1	5.0	8.3	10.1	11.7
R22	0.5	1.3	3.2	5.3	8.5	13.9	16.9	19.5
R404A / R507	0.4	1.0	2.3	3.9	6.2	10.1	12.3	14.2
R407C	0.5	1.4	3.5	5.7	9.2	15.0	18.3	21.1
R410A	0.6	1.5	3.7	6.2	9.9	16.2	19.7	22.8
R407A	0.5	1.3	3.2	5.2	8.4	13.7	16.6	19.2
R407F	0.6	1.5	3.6	5.9	9.5	15.5	18.9	21.8
R448A	0.5	1.3	3.19	5.28	8.48	13.86	16.85	19.44
R449A	0.49	1.27	3.12	5.16	8.28	13.54	16.46	19
R450A	0.2	0.55	1.3	2.11	3.41	5.66	6.89	7.98
R513A	0.21	0.56	1.33	2.16	3.49	5.79	7.05	8.17
R1234ze	0.23	0.63	1.49	2.42	3.91	6.49	7.9	9.15
R452A	0.4	1.0	2.4	4.0	6.4	10.5	12.8	14.8

Brazing Adapter for TILE and TIS(E)

Type	Part No.	Connection, ODF	
		(mm)	(inch)
TIA-M06	802 500	6.0	-
TIA-M10	802 501	10.0	-
TIA-014	802 502	-	1/4"
TIA-038	802 503	-	3/8"
Gasket Set	803 780	100 pieces	



*Nominal capacity is based on the following conditions:

Refrigerant	Evaporating Temperature	Condensing Temperature	Sub-cooling
R407C, R407F	+4°C +4°C dew point	+38°C bubble p. +42.9°C dew point	1K
R513A, R1234ze		+38°C bubble/ +38°C dew point	
R22, R134a, R404A, R410A, R507		+38°C bubble/ +38°C dew point	
R450A		+38°C bubble/ +38.6°C dew point	
R448A, R449A		+38°C bubble/ +42.6°C dew point	
R452A		+38°C bubble / +41.6°C dew point	

These effects have been integrated in selection program "Controls Navigator".

TI Valve Bodies Without Orifice and Nut

Refrigerant	Outlet/Equalizer Connection	Type	Part No.	Type	Part No.	MOP (°C)	Evaporating Temperature Range (°C)	
		External Equalizer		Internal Equalizer				
R404A / R507	Brazing Stainless Steel Fittings *	TILE-SW (12mm)	802465			-	-45 ... +20	
		TILE-SW (1/2")	802466			-	-45 ... +20	
	Brazing Copper Fittings **	TISE-SW (12mm)	802462		TIS-SW (12mm)	802461	-	-45 ... +20
		TISE-SW (1/2")	802464		TIS-SW (1/2")	802463	-	-45 ... +20
		TISE-SAD10 (1/2")	802479		TIS-SAD10 (1/2")	802478	+10	-45 ... 0
		TISE-SW75 (12mm)	802471				0	-45 ... -3
		TISE-SW75 (1/2")	802472				0	-45 ... -3
		TISE-SAD-20 (12mm)	802474				-20	-45 ... -27
		TISE-SAD-20 (1/2")	802475				-20	-45 ... -27
	Flare Fittings	TIE-SW	802460		TI-SW	802459	-	-45 ... +20
		TIE-SAD10	802477		TI-SAD10	802476	+10	-45 ... 0
		TIE-SW75	802470		TI-SW75	802469	0	-45 ... -3
		TIE-SAD-20	802473				-20	-45 ... -27
	R134a	Brazing Stainless Steel Fittings *	TILE-MW (12mm)	802451			-	-45 ... +20
TILE-MW (1/2")			802452			-	-45 ... +20	
Brazing Copper Fittings **		TISE-MW (12 mm)	802448		TIS-MW (12 mm)	802447	-	-45 ... +20
		TISE-MW (1/2")	802450		TIS-MW (1/2")	802449	-	-45 ... +20
		TISE-MW55 (12mm)	802457				+14	-45 ... +11
		TISE-MW55 (1/2")	802458				+14	-45 ... +11
Flare Fittings		TIE-MW	802446		TI-MW	802445	-	-45 ... +20
		TIE-MW55	802456		TI-MW55	802455	+14	-45 ... +11
R407C	Brazing Stainless Steel Fittings *	TILE-NW (12mm)	802486			-	-45 ... +20	
		TILE-NW (1/2")	802485			-	-45 ... +20	
	Brazing Copper Fittings **	TISE-NW (12mm)	802438		TIS-NW (12mm)	802437	-	-45 ... +20
		TISE-NW (1/2")	802440		TIS-NW (1/2")	802439	-	-45 ... +20
	Flare Fittings	TIE-NW	802436		TI-NW	802435	-	-45 ... +20
R407A/ R407F	Brazing Stainless Steel Fittings *	TILE-NW (12mm)	802486			-	-45 ... 0	
		TILE-NW (1/2")	802485			-	-45 ... 0	
	Brazing Copper Fittings **	TISE-NW (12mm)	802438		TIS-NW (12mm)	802437	-	-45 ... 0
		TISE-NW (1/2")	802440		TIS-NW (1/2")	802439	-	-45 ... 0
	Flare Fittings	TIE-NW	802436		TI-NW	802435	-	-45 ... 0
	Brazing Copper Fittings **	TISE-SAD-20 (12mm)	802474				-20	-45 ... -27
		TISE-SAD-20 (1/2")	802475				-20	-45 ... -27
R22	Brazing Stainless Steel Fittings *	TILE-HW (12mm)	802426			-	-45 ... +20	
		TILE-HW (1/2")	802427			-	-45 ... +20	
	Brazing Copper Fittings **	TISE-HW (12mm)	802423		TIS-HW (12mm)	802422	-	-45 ... +20
		TISE-HW (1/2")	802425		TIS-HW (1/2")	802424	-	-45 ... +20
		TISE-HW100 (12mm)	802431				+15	-45 ... +13
		TISE-HW100 (1/2")	802432				+15	-45 ... +13
	Flare Fittings	TIE-HW	802421		TI-HW	802420	-	-45 ... +20
R410A	Brazing Stainless Steel Fittings *	TILE-ZW (12mm)	802488			-	-35 ... +20	
		TILE-ZW (1/2")	802489			-	-35 ... +20	
		TILE-ZW175 (12mm)	802490			+16.4	-35 ... +15	
		TILE-ZW175(1/2")	802491			+16.4	-35 ... +15	

Note: *) TILE Brazing without wet rag **) TISE Brazing with wet rag

TI Valve Bodies Without Orifice and Nuts in Single Packaging

Refrigerant	Connection	Valves With Factory Setting and/or New Charges					Valve for Field Setting			
		Type	ad Part No.	Equalizer	Charge	MOP	Type	Part No.		
R448A/ R449A/ R452A	Brazeing Stainless Steel Fittings *	TILE-BW (12mm)	802418	External	Liquid	No	TILE-SW (12 mm)	802 465		
		TILE-BW (1/2")	802419		Liquid	No	TILE-SW (1/2")	802 466		
	Brazeing Copper Fittings **	TISE-BW (12 mm)	802416		Liquid	No	TISE-SW (12 mm)	802 462		
		TISE-BW (1/2")	802417		Liquid	No	TISE-SW (1/2")	802 464		
		TISE-BW30 (1/2")	802495		Vapor	Yes		-		
		TISE-BW30 (12mm)	802494							
		TISE-BW70 (1/2")	-		Vapor	Yes	TISE-SW75 (1/2")	802 472		
		TIS-BW (12 mm)	802414		Internal	Liquid	No	TIS-SW (12 mm)	802 461	
	TIS-BW (1/2")	802415	Liquid			No	TIS-SW (1/2")	802 463		
	Flare Fittings	TIE-BW	802413		External	Liquid	No	TIE-SW	802 460	
			-			Vapor	Yes	TIE-SW75	802 470	
		TI-BW	802412		Internal	Liquid	No	TI-SW	802 459	
R450A	Brazeing Stainless Steel Fittings *	TILE-DW (12 mm)	-	External	Liquid	No	TILE-MW (12 mm)	802 451		
		TILE-DW (1/2")	-		Liquid	No	TILE-MW (1/2")	802 452		
	Brazeing Copper Fittings **	TISE-DW (12 mm)	-		Liquid	No	TISE-MW (12 mm)	802 448		
		TISE-DW (1/2")	-		Liquid	No	TISE-MW (1/2")	802 450		
		TISE-DW55 (12 mm)	-		Vapor	Yes	TISE-MW55 (12 mm)	802 457		
		TISE-DW55 (1/2")	-		Vapor	Yes	TISE-MW55 (1/2")	802 458		
		TIS-DW (12 mm)	-		Internal	Liquid	No	TIS-MW (12 mm)	802 447	
		TIS-DW (1/2")	-			Liquid	No	TIS-MW (1/2")	802 449	
	Flare Fittings	TIE-DW	-		External	Liquid	No	TIE-MW	802 446	
		TI-DW	-		Internal	Liquid	No	TI-MW	802 445	
	R513A	Brazeing Stainless Steel Fittings *	TILE-CW (12 mm)		-	External	Liquid	No	TILE-MW (12 mm)	802 451
			TILE-CW (1/2")		-		Liquid	No	TILE-MW (1/2")	802 452
Brazeing Copper Fittings **		TISE-CW (12 mm)	-	Liquid	No		TISE-MW (12 mm)	802 448		
		TISE-CW (1/2")	-	Liquid	No		TISE-MW (1/2")	802 450		
		TISE-CW55 (12 mm)	-	Vapor	Yes		TISE-MW55 (12 mm)	802 457		
		TISE-CW55 (1/2")	-	Vapor	Yes		TISE-MW55 (1/2")	802 458		
		TIS-CW (12 mm)	-	Internal	Liquid		No	TIS-MW (12 mm)	802 447	
		TIS-CW (1/2")	-		Liquid		No	TIS-MW (1/2")	802 449	
Flare Fittings		TIE-CW	-	External	Liquid		No	TIE-MW	802 446	
		TI-CW	-	Internal	Liquid		No	TI-MW	802 445	
R1234ze		Brazeing Copper Fittings **	TISE-EW (12 mm)	-	External		Liquid	No	TISE-MW (12 mm)	802 448
			TISE-EW (1/2")	-			Liquid	No	TISE-MW (1/2")	802 450
	TISE-EW55 (12 mm)		-	Vapor		Yes	TISE-MW55 (12 mm)	802 457		
	TISE-EW55 (1/2")		-	Vapor		Yes	TISE-MW55 (1/2")	802 458		
	TIS-EW (12 mm)		-	Liquid		No	TIS-MW (12 mm)	802 447		
	TIS-EW (1/2")		-	Liquid		No	TIS-MW (1/2")	802 449		
	Flare Fittings	TIE-EW	-	Internal	Liquid	No	TIE-MW	802 446		
		TI-EW	-		Liquid	No	TI-MW	802 445		

Note: *) TILE Brazeing without wet rag**) TISE Brazeing with wet rag

Connections

Body	Inlet connection		Outlet	External equalizer*
	Brazeing with adapter	Flare		
TI(E) Flare connections	-	5/8"-18UNF Flare suitable for 6 mm, 8 mm, 10 mm, 1/4", 5/16", 3/8" tubes	3/4" - 16UNF Flare: for 12 mm, 1/2" tubes	7/16" - 20UNF Flare: for 6 mm, 1/4" tubes
TIS(E) / TILE Braze connections	TIA - M06 (6 mm ODF) TIA - M10 (10 mm ODF)		12 mm ODF	6 mm ODF
	TIA - 014 (1/4" ODF) TIA - 038 (3/8" ODF)		1/2 ODF	1/4" ODF

Note: *) TI and TIS with internal equalizer

Thermo™- Expansion Valves Series TX3

For OEM use, hermetic design

Features

- Hermetic design with brazing and straight through configuration
- Internal or external equalizer
- External superheat adjustment
- Large diaphragm eliminates disturbances to the valve and provides smoother valve control
- Very compact size
- Version with internal check valve eliminates external check valve for heat pump applications
- Capillary tube length 1.5m
- Max. Working Pressure PS: 45 bar
Medium Temperature Range TS: -45 ... +120°C
- Packaging units with 24 pieces, no single packs



MOP

MOP (bar)	Upper limit of Evaporating Temperature Range		
	R134A	R407C	R410A
3.3	+11°C		
6.4		+14.5°C	
12.9			+17°C

Note: Pressures are given in gauge pressure.

Selection Tables

R134A

Nominal Capacity (kw)	less MOP		with Standard-MOP		Equalizer	Inlet x Outlet / ODF
	Type	Part No.	Type	Part No.		
1.8	TX3-M02	801766M	TX3-M12	801778M	internal	1/4" x 3/8"
2.8	TX3-M03	801767M			internal	1/4" x 3/8"
4.0	TX3-M04	801768M			internal	3/8" x 1/2"
2.8	TX3-M023	801770M	TX3-M33	801782M	Ext. 1/4"	1/4" x 3/8"
4.0	TX3-M024	801771M	TX3-M34	801783M	Ext. 1/4"	3/8" x 1/2"
6.1	TX3-M025	801772M	TX3-M35	801784M	Ext. 1/4"	3/8" x 1/2"
8.3	TX3-M026	801773M	TX3-M36	801785M	Ext. 1/4"	3/8" x 1/2"
10.2	TX3-M027	801774M	TX3-M37	801786M	Ext. 1/4"	1/2" x 5/8"
12.1	TX3-M028	801775M	TX3-M38	801787M	Ext. 1/4"	1/2" x 5/8"
16.5	TX3-M029	801776M	TX3-M39	801788M	Ext. 1/4"	1/2" x 5/8"

R410A

Nominal Capacity (kw)	less MOP		with Standard-MOP		Equalizer	Inlet x Outlet / ODF
	Type	Part No.	Type	Part No.		
6.3			TX3-Z34	801944M	Ext. 1/4"	3/8" x 1/2"
9.4			TX3-Z35	801945M	Ext. 1/4"	3/8" x 1/2"
12.9			TX3-Z36	801946M	Ext. 1/4"	3/8" x 1/2"
15.8			TX3-Z37	801947M	Ext. 1/4"	1/2" x 5/8"
18.8			TX3-Z38	801948M	Ext. 1/4"	1/2" x 5/8"

R407C

Nominal Capacity (kw)	less MOP		with Standard-MOP		Equalizer	Inlet x Outlet / ODF
	Type	Part No.	Type	Part No.		
0.9	TX3-N01	801813M			internal	1/4" x 3/8"
3.9			TX3-N13	801828M	internal	1/4" x 3/8"
2.5	TX3-N22	801818M			Ext. 1/4"	1/4" x 3/8"
3.9	TX3-N23	801819M	TX3-M33	801832M	Ext. 1/4"	1/4" x 3/8"
5.6	TX3-N24	801820M	TX3-M34	801833M	Ext. 1/4"	3/8" x 1/2"
8.4	TX3-N25	801821M	TX3-M35	801834M	Ext. 1/4"	3/8" x 1/2"
11.6	TX3-N26	801822M	TX3-M36	801835M	Ext. 1/4"	3/8" x 1/2"
14.2	TX3-N27	801823M	TX3-M37	801836M	Ext. 1/4"	1/2" x 5/8"
16.9	TX3-N28	801824M	TX3-M38	801837M	Ext. 1/4"	1/2" x 5/8"
23.0			TX3-M39	801838M	Ext. 1/4"	1/2" x 5/8"

R407C for heat pump applications

Nominal Capacity (kw)	less MOP		with Standard-MOP		Equalizer	Inlet x Outlet / ODF
	Type	Part No.	Type	Part No.		
3.9	TX3-N63	806801M	Adjustable with internal check valve and special liquid charge for heat pump applications		Ext. 1/4"	1/4" x 3/8"
8.4	TX3-N65	806803M			Ext. 1/4"	3/8" x 1/2"
11.6	TX3-N66	806804M			Ext. 1/4"	3/8" x 1/2"
14.2	TX3-N67	806805M			Ext. 1/4"	1/2" x 5/8"
16.9	TX3-N68	806806M			Ext. 1/4"	1/2" x 5/8"
23	TX3-N69	806807M			Ext. 1/4"	1/2" x 5/8"

Nominal capacity (Q_n) is based on the following conditions:

Refrigerant	Evaporating temperature	Condensing temperature	Subcooling
R407C	+4°C dew point	+38°C bubble p.	1K
8.4	+4°C		1K

Thermo™-Expansion Valves Series TX7

TX7 series of Thermo™-Expansion Valves are designed predominantly for AC, heat pumps, close control and industrial process cooling applications. The TX7 is ideal for those applications requiring hermetic / compact size combined with stable and accurate control over wide load and evaporating temperature ranges.

Features

- Monoblock, hermetic valve with brazing connections
- 7 sizes up to 180 kW (R410A)
- Maximum working pressure: PS 46 bar
- Factory test pressure: PT 50.6 bar
- Bi-Flow application
 - Balanced port in normal and reverse flow directions eliminates disturbance forces resulting from condensing pressure
 - Optimum static superheat in normal and reverse flow
 - Capacities performance in normal and reverse flow correlates to capacity of heat pumps in cooling and heating mode
- Power Element with 65 mm diameter enables low partial load (20-25%) performance at stable superheat
- Applicable in systems with digital scroll, step less screw compressors and variable speed compressors
- Floating superheat in reverse flow (heating mode) supports evaporator efficiency during low ambient operating conditions in air cooled reversible chillers
- Laser welded stainless steel power element with a special diaphragm profile provides life expectancy against high pressure during reversed flow via external equalizer.
- Single diaphragm with negligible hysteresis withstands against higher pressure
- Fine tuning by external superheat adjusting mechanism
- Special factory setting upon request. Minimum order quantity 60 pieces



TX7-Z13

R410A / R32 Selection Table

Capacity, R410A [kW]		Capacity, R32 [kW]		With MOP		Connection	
Normal Flow	Reverse Flow	Normal Flow	Reverse Flow	Type	Part No.	Inlet x Outlet	Equalizer
32.1	31.7	47.7	46.9	TX7-Z13 m	806 811	12 mm x 16 mm	6 mm
32.1	31.7	47.7	46.9	TX7-Z13	806 810	1/2" x 5/8"	1/4"
39.9	39.1	59.3	57.8	TX7-Z14 m	806 813	16 mm x 22 mm	6 mm
39.9	39.1	59.3	57.8	TX7-Z14	806 812	5/8" x 7/8"	1/4"
48.9	47.4	72.7	70.1	TX7-Z15 m	806 815	16 mm x 22 mm	6 mm
48.9	47.4	72.7	70.1	TX7-Z15	806 814	5/8" x 7/8"	1/4"
80.7	67.7	120	100.2	TX7-Z16 m	806 817	22 mm x 28 mm	6 mm
80.7	67.7	120	100.2	TX7-Z16	806 816	7/8" x 1-1/8"	1/4"
99.4	81.5	147.9	120.5	TX7-Z17 m	806 819	22 mm x 28 mm	6 mm
99.4	81.5	147.9	120.5	TX7-Z17	806 818	7/8" x 1-1/8"	1/4"
130.9	113.9	194.7	168.4	TX7-Z18 m	806 821	22 mm x 28 mm	6 mm
130.9	113.9	194.7	168.4	TX7-Z18	806 820	7/8" x 1-1/8"	1/4"
183.4	165.1	272.9	244.1	TX7-Z19 m	806 823	22 mm x 28 mm	6 mm
183.4	165.1	272.9	244.1	TX7-Z19	806 822	7/8" x 1-1/8"	1/4"

R134a Selection Table

Capacity, R134a [Kw]		With MOP		Without MOP		Connection	
Normal Flow	Reverse Flow	Type	Part No.	Type	Part No.	Inlet x Outlet	Equalizer
18.1	17.9	TX7-M13 m	806 839	TX7-M03 m	806 825	12 mm x 16 mm	6 mm
18.1	17.9	TX7-M13	806 838	TX7-M03	806 824	1/2" x 5/8"	1/4"
22.5	22	TX7-M14 m	806 841	TX7-M04 m	806 827	16 mm x 22 mm	6 mm
22.5	22	TX7-M14	806 840	TX7-M04	806 826	5/8" x 7/8"	1/4"
27.5	26.7	TX7-M15 m	806 843	TX7-M05 m	806 829	16 mm x 22 mm	6 mm
27.5	26.7	TX7-M15	806842	TX7-M05	806 828	5/8" x 7/8"	1/4"
45.4	38.2	TX7-M16 m	806 845	TX7-M06 m	806 831	22 mm x 28 mm	6 mm
45.4	38.2	TX7-M16	806844	TX7-M06	806 830	7/8" x 1-1/8"	1/4"
56.0	45.9	TX7-M17 m	806 847	TX7-M07 m	806 833	22 mm x 28 mm	6 mm
56.0	45.9	TX7-M17	806846	TX7-M07	806 832	7/8" x 1-1/8"	1/4"
73.7	64.1	TX7-M18 m	806 849	TX7-M08 m	806 835	22 mm x 28 mm	6 mm
73.7	64.1	TX7-M18	806848	TX7-M08	806 834	7/8" x 1-1/8"	1/4"
103.3	93	TX7-M19 m	806 851	TX7-M09 m	806 837	22 mm x 28 mm	6 mm
103.3	93	TX7-M19	806850	TX7-M09	806 836	7/8" x 1-1/8"	1/4"

R407C Selection Table

Capacity, R407C [kw]		With MOP		Without MOP		Connection	
Normal Flow	Reverse Flow	Type	Part No.	Type	Part No.	Inlet x Outlet	Equalizer
28.9	28.6	TX7-N13 m	806 868	TX7-N03 m	806 853	12 mm x 16 mm	6 mm
28.9	28.6	TX7-N13	806 867	TX7-N03	806 852	1/2" x 5/8"	1/4"
36.0	35.2	TX7-N14 m	806 870	TX7-N04 m	806 855	16 mm x 22 mm	6 mm
36.0	35.2	TX7-N14	806 869	TX7-N04	806 854	5/8" x 7/8"	1/4"
44.1	42.7	TX7-N15 m	806 872	TX7-N05 m	806 857	16 mm x 22 mm	6 mm
44.1	42.7	TX7-N15	806 871	TX7-N05	806 856	5/8" x 7/8"	1/4"
72.7	61.1	TX7-N16 m	806 874	TX7-N06 m	806 859	22 mm x 28 mm	6 mm
72.7	61.1	TX7-N16	806 873	TX7-N06	806 858	7/8" x 1-1/8"	1/4"
89.7	73.5	TX7-N17 m	806 876	TX7-N07 m	806 861	22 mm x 28 mm	6 mm
89.7	73.5	TX7-N17	806 875	TX7-N07	806 860	7/8" x 1-1/8"	1/4"
118.1	102.7	TX7-N18 m	806 878	TX7-N08 m	806 863	22 mm x 28 mm	6 mm
118.1	102.7	TX7-N18	806 877	TX7-N08	806 862	7/8" x 1-1/8"	1/4"
165.4	148.9	TX7-N19 m	806 880	TX7-N09 m	806 865	22 mm x 28 mm	6 mm
165.4	148.9	TX7-N19	806 879	TX7-N09	806 864	7/8" x 1-1/8"	1/4"

R450A / R513A Selection Table

Capacity, R450A [kW]	Capacity, R513A [kW]	With MOP		Without MOP		Connection	
		Type	Part No.	Type	Part No.	Inlet x Outlet	Equalizer
15.9	16.3	TX7-M13 m	806 839	TX7-M03 m	806 825	12 mm x 16 mm	6 mm
15.9	16.3	TX7-M13	806 840	TX7-M03	806 824	1/2" x 5/8"	1/4"
19.8	20.3	TX7-M14 m	806 841	TX7-M04 m	806 827	16 mm x 22 mm	6 mm
19.8	20.3	TX7-M14	806 842	TX7-M04	806 826	5/8" x 7/8"	1/4"
24.3	24.8	TX7-M15 m	806 843	TX7-M05 m	806 829	16 mm x 22 mm	6 mm
24.3	24.8	TX7-M15	806 844	TX7-M05	806 828	5/8" x 7/8"	1/4"
40.1	41.0	TX7-M16 m	806 845	TX7-M06 m	806 831	22 mm x 28 mm	6 mm
40.1	41.0	TX7-M16	806 846	TX7-M06	806 830	7/8" x 1-1/8"	1/4"
49.4	50.6	TX7-M17 m	806 847	TX7-M07 m	806 833	22 mm x 28 mm	6 mm
49.4	50.6	TX7-M17	806 848	TX7-M07	806 832	7/8" x 1-1/8"	1/4"
65.0	66.6	TX7-M18 m	806 849	TX7-M08 m	806 835	22 mm x 28 mm	6 mm
65.0	66.6	TX7-M18	806 850	TX7-M08	806 834	7/8" x 1-1/8"	1/4"
91.1	93.3	TX7-M19 m	806 851	TX7-M09 m	806 837	22 mm x 28 mm	6 mm
91.1	93.3	TX7-M19	806 852	TX7-M09	806 836	7/8" x 1-1/8"	1/4"

The TX7-xxx with standard charges can be used with systems having R450A, R513a, and R32 considering the readjustment of factory setting. The readjusting depends to designed evaporating temperature. For more details see operating instructions.

The nominal capacity (Q_n) is based on the following conditions:

Refrigerant	Evaporating temperature [°C]	Condensing temperature [°C]	Subcooling
R134A, R22	+4 °C	+38°C	1K
R407C,	+4 °C	+38°C bubble point/ +43 °C dew point	1K
R440A, R513A	+4 °C	+38°C	1K
R410A, R32	+4 °C	+38°C	1K

Charge	Refrigerant	Recommended Evaporating Temperature Range [°C]	Maximum Bulb Temperature [°C]
M0	R134a	-25...+30	88
N0	R407C	-25...+20	71
M1 MOP 3.8 Bar	R134a	-25...+10	120
N1 MOP 6.9 Bar	R407C	-25...+14	120
Z1 MOP 12.1 Bar	R410A/ R32	-25...+14	120

Thermo™-Expansion Valve Series T Exchangeable Power Assemblies and Orifices

Features

- Modular design for economical logistics and easy assembly and servicing
- Very good stability due to large diaphragm diameter
- Constant superheat across a wide application range
- Superior partial load performance due to double seat orifice design (TJRE, TERE, TIRE & THRE)
- Bi-flow capability for applications in heat pumps
- Capillary tube length 1.5 m (TCLE, TJRE) and 3m (TERE, TIRE & THRE)
- Max. working pressure PS:
 - 46 bar with XB power assembly
 - 31 bar with XC power assembly
- Medium Temperature range TS: -45...+75°C
- Flanges: brazing ODF/ODM connection



TCLE

Type Code Valve

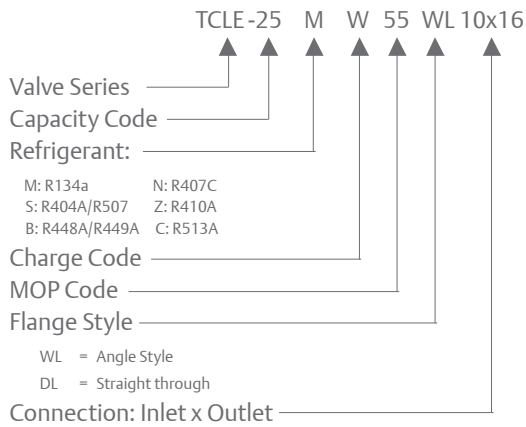

Type Code Power Element

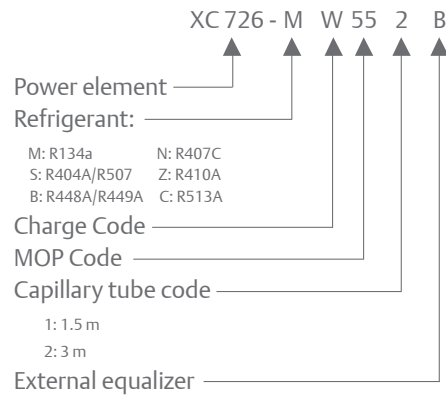

Nominal Capacities for Orifices

Valve Series	R134a/R513A/R450A			R404A/R507 R452A			R448A/ R449A		R407C		Orifice Type	Power Element Type
	Type	R134a (kW)	R513A/ R450A (kW)	Type	R404A/ R507 (kW)	R452A (kW)	Type	R448A/ R449A (kW)	Type	R407C (kW)		
TCLF-	25 MW	1.5	1.3	25 SW	1.3	1.4	25 BW	1.9	50 NW	2.1	X 22440-B1B	XB1019...1B
	75 MW	2.9	2.6	75 SW	2.6	2.8	100 BW	3.7	100 NW	4.0	X 22440-B2B	
	150 MW	6.1	5.6	150 SW	5.5	6.0	200 BW	7.9	200 NW	8.5	X 22440-B3B	
	200 MW	9.3	8.4	200 SW	8.3	9.0	250 BW	11.9	300 NW	12.9	X 22440-B3.5B	
	250 MW	13.5	12.2	250 SW	12.1	13.1	300 BW	17.3	400 NW	18.7	X 22440-B4B	
	350 MW	17.3	15.7	400 SW	15.5	16.8	500 BW	22.1	550 NW	24.0	X 22440-B5B	
	550 MW	23.6	21.5	600 SW	21.2	23.0	800 BW	30.3	750 NW	32.9	X 22440-B6B	
	750 MW	32.0	29.0	850 SW	28.7	31.1	1100 BW	41.0	1000 NW	44.4	X 22440-B7B	
	900 MW	37.2	33.8	1000 SW	33.4	36.2	1300 BW	47.7	1150 NW	51.7	X 22440-B8B	
TJRE-	11 MW	45	40	12 SW	40	43.9	15 BW	58	14 NW	62	X 11873-B4B	XC726...2B
	13 MW	57	52	14 SW	51	56	18 BW	74	17 NW	80	X 11873-B5B	
TERE-	16 MW	71	64	18 SW	63	69	23 BW	91	21 NW	99	X 91117-B6B	
	19 MW	81	73	20 SW	72	79	26 BW	104	25 NW	112	X 91117-B7B	
	25 MW	112	100	27 SW	99	108	35 BW	143	33 NW	155	X 91117-B8B	
	31 MW	135	121	34 SW	120	132	44 BW	174	42 NW	188	X 91117-B9B	
TIRE-	45 MW	174	156	47 SW	154	169	60 BW	222	52 NW	241	X 9166-B10B	
THRE-	55 MW	197	177	61 SW	174	192	78 BW	252	71 NW	273	X 9144-B11B	
	68 MW	236	211	77 SW	209	229	98 BW	301	94 NW	327	X 9144-B13B	

Note 1: R450A, R513A can be used with MW charge. For valve readjustment see HFO/HFO blends Product Guide.

Note 2: R452A can be used with SW charge. For valve readjustment see R452A Product Guide.

Note 3: R410A available with Power element XB1019-ZW175-1B. Nominal capacity range 2.2...86.4 kW.

Note 4: R407A/ R407F can be used with NW/ SW40 charges and readjustment of valve. Nominal capacity range ≈ 2...338 kW.

The Nominal Capacity is Based on the Following Conditions:

Refrigerant	Evaporating temperature	Condensing temperature	Subcooling
R134a, R404A, R507, R513A, R1234ze, R410A	+4°C dew point	+38°C bubble/ +38°C dew point	1K
R407F, R407A		38°C bubble / +42.4°C dew point	
R450A		+38°C bubble/ +38.6°C dew point	
R448A, R449A,		+38°C bubble/ +42.6°C dew point	
R407C		+38°C bubble/ +42.9°C dew point	
R452A		+38°C bubble/ +41.6°C dew point	

For selection of other operating conditions, please use „Controls Navigator“ selection program.

Selection Table Power Element and Recommended Flanges

Valve series	Orifice type	Angle style type	Straight through type	Connection (inlet x outlet)		Power Element Type
				Metric	Imperial	
TCLC	X22440-B1B / B2B / B3B / B3.5B / B4B	C501-5	9761-3	-	3/8"x5/8" ODF	XB1019...1B
		C501-5mm	9761-3mm	10x16 mm ODF	-	
	X22440-B5B / B6B	C501-7	9761-4	-	1/2"x5/8" ODF	
		C501-7mm	9761-4mm	12x16 mm ODF	-	
	X22440-B7B / B8B	-	6346-17	16x22 mm ODF	5/8"x7/8" ODF	
		A576	-	-	5/8"x7/8" ODF 7/8"x1-1/8" ODM	
A576-mm		-	16x22 mm ODF 22x28 mm ODM	-		
TJRE	X11873-B4B / B5B	10331	10332	22x22 mm ODF	7/8"x7/8" ODF 1-1/8"x1-1/8" ODM	
TERE	X9117-B6B / B7B / B8B / B9B	9153 9153-mm	9152 9152-mm	22x22 mm ODF 22x28 mm ODM	7/8"x7/8" ODF 1-1/8"x1-1/8" ODM	XC726...2B
TIRE						
THRE	X9144-B11B / B13B	9149	9148	22x22 mm ODF	7/8"x7/8" ODF 1-1/8"x1-1/8" ODM	

MOP Charges T-Series

MOP		Evaporating Temperature Range °C				
Code	Bar	R134a MW	R404A/ R507 SW	R407C NW	R410A ZW	R448A/ R449A BW
15	1.0	-45...-16				
30	2.1					-45...-18
35	2.4	-45...0				
40	2.8		-45...-18			
55	3.8	-45...+11	-45...-10			
75	5.2		-45...-2			
80	5.5		-45...0			
100	6.9			-45...+14		
175	12.1				-45...+16	

Accessories and Spare Parts

Description	Type	Part No.
Service Tool for T, ZZ, L and 935 Series valves	X 99999	800005
Gasket sets for T, ZZ, L and 935 Series valves	X 13455-1	027579
Steel Screws for flange types: C501, 9761, 6346, A576	Screw ST 32	803573
Steel Screws for flange types: 9148, 9149, 9152, 9153, 10331, 10332	Screw ST 48	803574

Thermo™ - Expansion Valve Series ZZ

for Low Evaporating Temperatures Between -45 and -100°C

Features

- Modular design for economical logistics and easy assembly and servicing
- Very good stability due to large diaphragm diameter
- High-quality materials and processes for high reliability and long lifetime
- To withstand stress at extremely low temperatures, ZZ-Series valves feature bronze bolts.
- Max. working pressure PS:
- 31 bar with XC power assembly



Type Code Valve

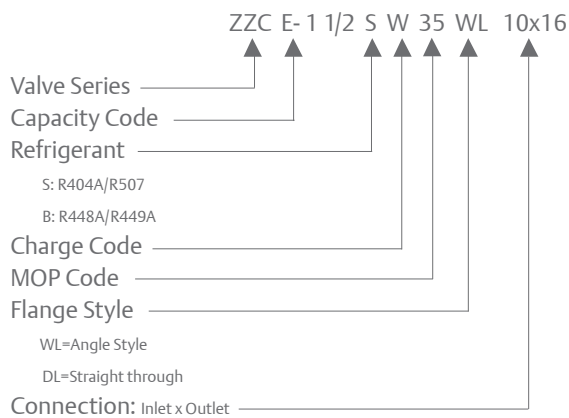

Type Code Power Element

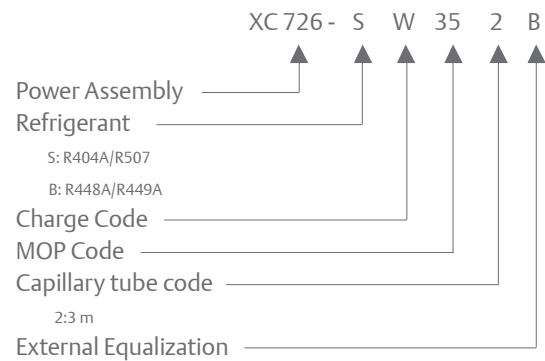

Selection table and Nominal Capacities

Valve Series	R23		R404A / R507		R448A/ R449A		Orifice	Power Assembly
	Type	Nominal Capacity (kW)	Type	Nominal Capacity (kW)	Type	Nominal Capacity (kW)		
ZZCE	2 BG	1.9	2/4 SW	1.2	1BW	1.7	X 10-B01	XC726 ... 2B
	6 BG	4.0	1 1/2 SW	2.6	2BW	3.7	X 10-B02	
	8 BG	6.8	2 1/2 SW	4.4	3BW	6.2	X 10-B03	
	12 BG	10.8	3 1/2 SW	7.0	5BW	9.8	X 10-B04	
	17 BG	16.3	5 SW	10.6	6BW	14.8	X 10-B05	
	25 BG	21.7	8 SW	14.1	10BW	19.8	X 10-B06	
	31 BG	27.1	9 SW	17.6	12BW	24.7	X 10-B07	

Note: Attention - To withstand stress at extremely low temperatures, ZZ-Series valves feature bronze bolts. Please order separately Screw BZ 32 Part No. 803575, Screw BZ 48 Part No. 803576

Nominal capacity (Q_n) is based on the following conditions:

Refrigerant	Evaporating temperature	Condensing temperature	Subcooling
R23	-60°C	-25°C	1K
R448A, R449A	-40°C	25°C bubble / 30,1°C dew point	
R404A, R507	-40°C	25°C	

For selection of other operating conditions, please use „Controls Navigator“ selection program.

Selection table Power Element and Recommended Flanges

Valve Series	Orifice type	Connection Standard Flange, Angle Style		Connection (inlet x outlet)		Power Element Type
		Type	Type	Metric	Imperial	
ZZCE	X 10-B01/ B02/ B03	C501-5mm		10 X 16 mm ODF		XC726 ... 2B
			C501-5		3/8" X 5/8 ODF	
	X 10-B04/ B05	C501-7 mm		12x16 mm ODF		
			C501-7		1/2"x5/8" ODF -	
	X 10-B04/ B05	A 576 mm		16x22 mm ODF		
			A 576	22x28 mm ODM	5/8"x7/8" ODF	

MOP Charges ZZ-Series

MOP Code	MOP		Evaporating Temperature Range °C		
	bar	Tmax	R23	R404A/R507	R448A/ R449A
20	1.4	-66°C	-100 ... -71		
35	2.1	-14°C			-75 ... -18
40	2.8	-14°C		-75 ... -18	
55	3.8	-7°C		-75 ... -10	
60	4.1	-48°C	-100 ... -51		
125	8.6	-32°C	-100 ... -35		

Accessories and Spare Parts

Description	Type	Part No.
Service Tool for T, ZZ, L and 935 Series valves	X 99999	800005
Gasket sets for T, ZZ, L and 935 Series valves	X 13455-1	027579
Bronze screw for Flange types: C500, C501, 9761, X6346, X6669, A576	Screw BZ 32	803575

Thermo™-Expansion Valves L-Series Exchangeable Power Assemblies and Orifices

Features

- Applications for Series L valves include superheat control (desuperheating of suction gas i.e., in hotgas bypass systems and interstage cooling in multiple stage compressors)
- Modular design for economical logistics and easy assembly and servicing
- Very good stability is attained because of the large forces generated by the large diaphragm diameter
- High-quality materials and processes for high reliability and long lifetime
- Superior partial load performance due to seat orifice design (LJRE, LERE & LIRE)
- Max. working pressure PS
 - 46 bar with XB power assembly
 - 31 bar with XC power assembly.
- Medium Temperature Range TS: -45...+65°C



Type Code Valve

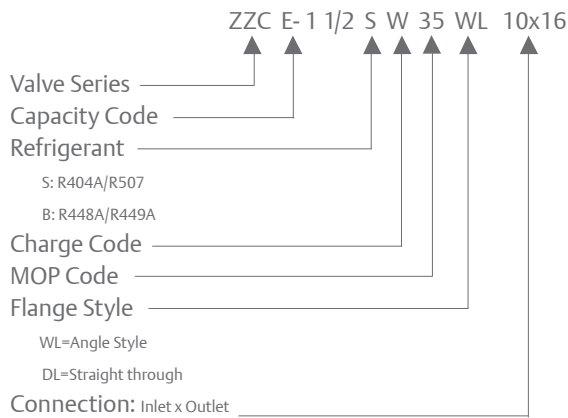

Type Code Power Assembly

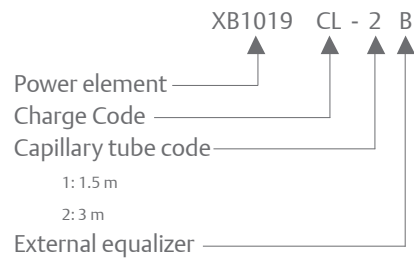

Nominal Capacities for Cages

Valve Series	Capacity code *	Nominal Capacity Q _n kW								Orifice Type	Power Assembly Type
		R134a (kW)	R404A/R507 (kW)	R407C (kW)	R407A (kW)	R4071F (kW)	R448A/R449A (kW)	R450A	R513A		
LCLE	1 *	1.5	1.3	2.1	1,9	2,1	1.9	1.3	1.3	X 22440-B1B	XB1019...2B
	2 *	2.9	2.6	4.0	3,6	4,1	3.7	2.5	2.6	X 22440-B2B	
	3 *	6.1	5.6	8.5	7,8	8,8	7.9	5.4	5.5	X 22440-B3B	
	3.5 *	9.3	8.4	12.9	21,9	13,3	11.9	8.1	8.3	X 22440-B3.5B	
	4 *	13.5	12.2	18.7	17,0	19,3	17.3	11.8	12.1	X 22440-B4B	
	6 *	17.3	15.7	24.0	11,7	24,8	22.1	15.1	15.5	X 22440-B5B	
	7 *	23.6	21.5	32.9	29,9	34,0	30.3	20.7	21.2	X 22440-B6B	
	9 *	32.0	29.0	44.4	40,5	45,9	41.0	28.0	28.7	X 22440-B7B	
LJRE-	10 *	37.2	33.8	51.7	47	53	47.7	32.6	33.4	X 22440-B8B	XB1019...2B
	11 *	45	40	62	57	65	58	40	40	X 11873-B4B	
LERE	12 *	57	51	80	73	83	74	50	52	X 11873-B5B	XC726...2B
	13 *	71	63	99	90	102	91	62	64	X 91117-B6B	
	14 *	81	72	112	102	116	104	71	73	X 91117-B7B	
LIRE-	15 *	112	99	155	141	160	143	98	100	X 91117-B8B	XC726...2B
	16 *	135	120	188	171	194	174	119	121	X 91117-B9B	
LIRE-	17 *	174	154	241	219	249	222	152	156	X 9166-B10B	

Note: *) Please indicate designation character for desired superheat.

The nominal capacity is based on the following conditions:

Refrigerant	Evaporating temperature [°C]	Condensing temperature [°C]	Subcooling
R134a, R22, R513A, R404A, R507	+4°C Dew Point	+38°C bubble/ +38°C dew point	1K
R448A, R449A		+38°C bubble/ +42.6°C dew point	
R450A		+38°C bubble / +38.6°C dew point	
R407C		+38°C bubble/ +42.9°C dew point	
R407A, R407A		+38°C bubble/ +42.4°C dew point	

For selection of other operating conditions, please use „Controls Navigator“ selection program.

Selection Table Power Assembly and Recommended Flanges

Valve Series	Orifice Type	Connection Standard Flange, Angle Style		Connection (inlet x outlet)		Power Element Type
		Type	Type	Metric	Imperial	
LCLE	X22440-B1B / B2B / B3B / B3.5B / B4B		C501-5	-	3/8"x5/8" ODF	XB1019...1B
		C501-5mm		10x16 mm ODF		
	X22440-B5B / B6B		C501-7		1/2"x5/8" ODF	
		C501-7mm		12x16 mm ODF		
			A576		5/8"x7/8" ODF 7/8"x1-1/8" ODF	
	A576-mm		16x22 mm ODF 22x28 mm ODM	-		
LJRE	X11873-B4B / B5B	10331	10331	22x22 mm ODF	7/8"x7/8" ODF 1-1/8"x1-1/8" ODM	XC726...2B
LERE/ LIRE	X9117-B6B / B7B / B8B / B9B / B10B		9153	-	7/8"x7/8" ODF 1-1/8"x1-1/8" ODM	
		9153-mm		22x22 mm ODF 22x28 mm ODM		

Suction Gas Superheat Selection:

* Charge Code	Refrigerant							
	R134a	R404A/R507	R407C	R410A	R448A/R449A	R450A	R513A	R407A/R407F
CL		22 K	13 K	30 K	16K	-	-	22 K
GL	15 K	35 K	25 K	33	27K	9K	-	35 K
UL	30 K		40 K	47	-	16K	24 K	-

Note: *) Please Indicate Designation Character for Desired Superheat.

Accessories and Spare Parts

Description	Type	Part No.
Service Tool for T, ZZ, L and 935 Series valves	X 99999	027 579
Gasket sets for T, ZZ, L and 935 Series valves	X 13455 -1	800 005
Gasket sets for T, ZZ, L and 935 Series valves Steel Screws for flange types: C500, C501, 9761, X6346, X6669, A576	Screw ST 32	803 573
Steel Screws for flange types: 9148, 9149, 9152, 9153, 10331, 10332	Screw ST 48	803 574

Liquid Injection Valves Series 935

Exchangeable Power Assemblies and Orifices

Features

- Modular design for economical logistics and easy assembly and servicing
- Very good stability is attained because of the large forces generated by the large diaphragm diameter
- High-quality materials and processes for high reliability and long lifetime
- Combinations of different charges with various orifice springs cover a very large application range
- Max. working pressure PS:
 - 46 bar with XB power assembly
 - 31 bar with XC power assembly.
- Medium Temperature Range TS: -45...+65°C



Type Code Valve

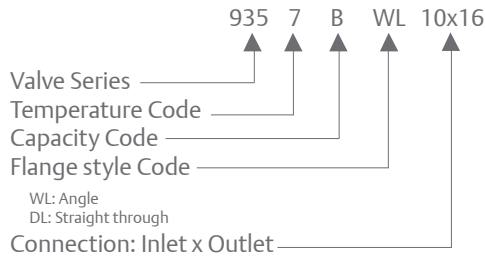

Type Code Power Assembly

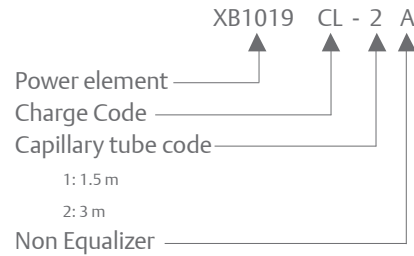

Nominal Capacities for Cages

Valve Series	Capacity code*	Nominal Capacity Q _n kW									Orifice Type	Power Element Type
		R134a (kW)	R404A/R507 (kW)	R407C	R407F	R407A	R448A/R449A	R450A	R513A	R1234ze		
935- *-	A	4.0	3.8	5.6	5.8	5.1	5.2	3.5	3.6	3.1	X10-**-01	XB1019 - ** - 2A
	B	7.8	7.4	10.9	11.3	9.9	10.1	6.9	7.1	6.1	X10-**-02	
	C	11.1	10.3	15.4	15.9	14.0	14.2	9.7	9.9	8.6	X10-**-03	
	D	16.3	15.6	22.8	23.6	20.7	21.0	14.4	14.7	12.8	X10-**-04	
	E	22.5	21.0	31.2	32.3	28.4	28.8	19.7	20.2	17.5	X10-**-05	
	G	32.0	29.9	44.5	46.1	40.5	41.1	28.1	28.8	24.9	X10-**-06	
	X	46.6	43.5	64.9	67.1	58.9	59.8	40.9	41.9	36.3	X10-**-07	

*) Temperature Code	Temperature Range °C	**) Spring code	***) Charge code
3	-1 ... +17	B	UL
6	+14 ... +38	C	KL
105	+44 ... +70	C	YL
106	+66 ... +94	C	JL
100	+94 ... +121	C	LL

The nominal capacity is based on the following conditions:

Refrigerant	Evaporating temperature [°C]	Condensing temperature [°C]	Subcooling
R134a, R513A, R404A, R507, R1234ze,	+4°C dew Point	+38°C bubble/ +38°C dew point	1K
R448A, R449A		+38°C bubble/ +42.6°C dew point	
R450A		+38°C bubble / +38.6°C dew point	
R407C		+38°C bubble/ +42.9°C dew point	
R407F, R407A		+38°C bubble/ +42.4°C dew point	

For selection of other operating conditions, please use „Controls Navigator“ selection program.

Selection Table Power Assembly and Recommended Flanges

Valve Series	Orifice Type	Connection Standard Flange, Angle Style		Connection (inlet x outlet)		Power Element Type
		Type	Type	Metric	Imperial	
935	X 10- [*] 01/ [*] 02/ [*] 03	C501-5 mm		10 X 16 mm ODF		XB1019- [*] [*] [*] -2A
			C501-5		3/8" X 5/8 ODF	
	X 10- [*] 04/ [*] 05	C501-7 mm		12x16 mm ODF		
			C501-7		1/2"x5/8" ODF -	
	X 10- [*] 06/ [*] 07	A 576 mm		16x22 mm ODF 22x28 mm ODM		
			A 576		5/8"x7/8" ODF 7/8"x1-1/8" ODM	

Accessories and Spare Parts

Description	Type	Part No.
Service Tool for T, ZZ, L and 935 Series valves	X 99999	800005
Gasket sets for T, ZZ, L and 935 Series valves	X 13455-1	027579
Steel Screws for flange types: C500, C501, 9761, X6346, X6669, A576	Screw ST 32	803573
Bulb clamp for XB1019	XA 1728-4	803260

Note: See "Controls Navigator" for More Information on Selection and Adjustment Guidelines.

Overview Flange for Take Apart Valves

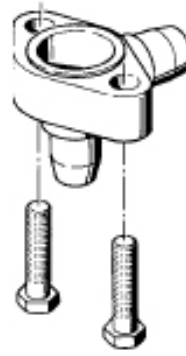

Angle Style Flange
(WL)

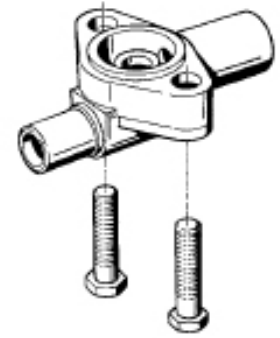

Straight Through Flange
(DL)

Flanges: T- / L-Series								
Valve Series	Orifice Type	Angle Style		Straight Through		Connection (Inlet x Outlet)		
		Type	Part No.	Type	Part No.	Metric	Imperial	
TCLE / LCLE	X22440-B1B / B2B/ B3B / B3.5B / B4B	C501-5	803232	9761-3	803240	-	3/8"x5/8" ODF	
		C501-5mm	803233	9761-3mm	803241	10x16mm ODF		
	X22440-B5B / B6B	C501-7	803234	9761-4	803350		1/2"x5/8" ODF	
		C501-7mm	803235	9761-4mm	803243	12x16mm ODF	-	
	X22440-B7B / B8B	-	-	-	6346-17	803330	16x22mm ODF	5/8"x7/8" ODF
		A576	803238	-	-	-	-	5/8"x7/8" ODF 7/8"x1-1/8" ODM
A576-mm		803239	-	-	-	16x22mm ODF 22x28mm ODM	-	
TJRE / LJRE	X11873-B4B / B5B	10331	803338	10332	803324	22x22mm ODF	7/8"x7/8" ODF 1-1/8"x1-1/8" ODM	
TERE/ TIRE	X9117-B6B / B7B / B8B / B9B / X9166-B10B	9153	803244	9152	803286	-	7/8"x7/8" ODF 1-1/8"x1-1/8" ODM	
LERE/ LIRE		9153-mm	803245	9152-mm	803287	22x22mm ODF 28x28mm ODM		
THRE	X9144-B11B / B13B	9149	803284	9148	803283	22x22mm ODF	7/8"x7/8" ODF 1-1/8"x1-1/8" ODM	

Flanges: 935- / ZZ-Series								
Valve Series	Orifice Type	Angle Style		Straight Through		Connection (Inlet x Outlet)		
		Type	Part No.	Type	Part No.	Metric	Imperial	
935 / ZZ	X10-*01 / *02 / *03	C501-5	803232	9761-3	803240	-	3/8"x5/8" ODF	
		C501-5mm	803233	9761-3mm	803241	10x16mm ODF		
	X10-*04 / *05	C501-7	803234	9761-4	803350		1/2"x5/8" ODF	
		C501-7mm	803235	9761-4mm	803243	12x16mm ODF	-	
	X10-*06 / *07	-	-	-	6346-17	803330	16x22mm ODF	5/8"x7/8" ODF
		A576	803238	-	-	-	-	5/8"x7/8" ODF 7/8"x1-1/8" ODM
A576-mm		803239	-	-	-	16x22mm ODF 22x28mm ODM	-	



Solenoid Valves

Basic Terms and Technical Information Operating Principles

Directly actuated: The magnetic field of the solenoid coil forces a movement of the plunger and thus causes the opening of the valve seat.

Servo actuated: The magnetic field of the solenoid coil is only utilized for the opening of the pilot valve seat. The necessary energy to actuate the piston or diaphragm of the main valve seat is provided by the refrigerant flow and results in a certain pressure drop.

Minimum Pressure Drop

Directly actuated solenoid valves do not require a minimum pressure drop for proper operation.

Servo operated solenoid valves require a minimum pressure drop of approximately 0.05 bar to remain fully open. In case of insufficient refrigerant flow, this value will not be reached and the solenoid valve may close unintentionally. These closures may lead to malfunctions and oscillations in the refrigeration circuit. Improper sizing of solenoid valves (i.e., use of excessively large solenoid valves) is the main cause of this effect. This is particularly important in capacity controlled refrigeration circuits.

Therefore the decisive factor for proper solenoid valve sizing is the respective capacity of the valve and not its connection size.

Formula for calculating the actual pressure drop of a solenoid valve:

$$\Delta_{p1} = \Delta_{p2} \times (Q_{n1}/Q_{n2})^2$$

- Δ_{p1} : Actual pressure drop
- Δ_{p2} : Nominal pressure drop at Q_{n1}
- Q_{n1} : Calculated nominal capacity
- Q_{n2} : Nominal capacity of selected valve

Maximum Operating Pressure Differential (MOPD)

MOPD is the maximum pressure differential between inlet and outlet of the solenoid valve which permits proper opening of the valve. When used with Alco AC solenoid coils all Alco solenoid valves employ 25 bar MOPD.

Operation in conjunction with DC solenoid coils lead to reduced MOPD values depending on valve type and size. The DS2 Chopper Plugs allow the use of 24VAC coils with 24VDC by converting the DC in an AC voltage. Please contact Emerson Climate Technologies application engineering for additional details.

Type Code

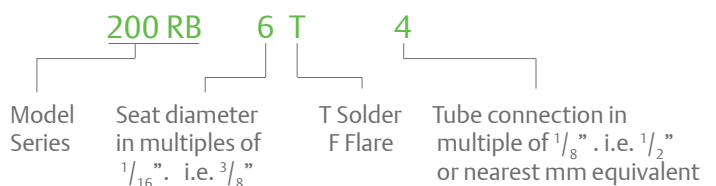

Selection Guide for Solenoid Valves

Selection Criteria	Series						
	110 RB	200 RB / 200 RH	240 RA		540 RA		M36
			8/9/12/16T9	16T11/20	8/9/12/16	20	
2-Way	+	+	+	+	+	+	
3-Way							+
Normally Closed (NC)	+	+	+	+			
Normally Open (NO)					+	+	
Min. Pressure Differential (bar)	0.00	0.05	0.05	0.05	0.05	0.05	
MWP (bar)	31	31 / 60	31	31	31	28	35
Media Temp. Range (°C)	-40 / +120	-40 / +120	-40 / +120	-40 / +120	-40 / +120	-40 / +120	-40 / +120
Coil Type	ASC	ASC	ASC	ASC	ASC	ASC	ASC



Coils ASC and Cable Assemblies

Standards

- ASC Coils and cable assemblies conform to Low Voltage Directive

Type	Part No.	Voltage	Power Input	Electr. Connection	Protection
ASC 230V / 50 (60) Hz	801 064	AC	8 W	without plug see cable assemblies	IP65 with plug / cable as- sembly
ASC 120V / 50 (60) Hz	801 063				
ASC 24V / 50 (60) Hz	801 062				
ASC 24V DC	801 974	DC	15 W		
DS2-N15 + ASC3 24VAC	804 620 + 801 062	DC	3 W	with plug and cable assembly	IP65

Note: Coils are delivered with retainer kit.
Please order cable assemblies separately.



ASC

Cable Assemblies for ASC Coils

Type	Part No.	Temperature Range	Cable Length	Wire Diameter	Connector Type
ASC-N15	804 570	-50 .. +80°C for stationary use only	1.5m	3 x 0.75 mm ²	loose wires
ASC-N30	804 571		3.0m		
ASC-N60	804 572		6.0m		



ASC-N15

Cable Assembly With 24V DC Chopper Plug

- Enables standard 24V AC Coil to be used for DC applications
- Low power assumption (3W only)
- No MOPD degradation

Type	Part No.	Temperature Range	Cable Length	Wire Diameter	Connector Type
DS2-N15	804 620	-25 .. +80°C	1.5 m	2 x 0.75 mm ²	loose wires



DS2-N15

ASC 24V

Other Accessories for Solenoid Valves

Type	Part No.	Description
X 11981-1	027 451	Service tool for 110RB. 240RA. 540RA. 3031
ASC-K01	801 295	Coil clip
PG9 Plug	801 012	Plug according to EN 175301 with cable gland PG 9
PG11 Plug	801 013	Plug according to EN 175301 with cable gland PG 11

2-Way Solenoid Valves Series 110, 200, 240

Normally Closed

Features

- Compact size
- No disassembly necessary for soldering

Standards

- 240 RA 16T11 and 20 are CE marked per PED

Accessories

- Actuation coil and cable assemblies available for various voltages, see 'Coils ASC3 and Cable Assemblies'



Capacity Data

Type	Nominal Capacity Q_n (kW)										Kv-Value m_3/h	Δp Min Bar
	Liquid											
	R134a	R22	R404A R507	R407C	R407F	R450A	R513A	R1234ze	R448A	R449A		
110 RB 2	3.5	3.8	2.5	3.6	4.2	2.6	2.7	2.3	3.8	3.7	0.2	0.05
200 RB 3	6.6	7.1	4.6	6.8	7.9	4.8	5.0	4.3	7.1	6.9	0.4	
200 RB 4	15.5	16.8	10.9	16.1	18.8	11.5	11.7	10.2	16.8	16.4	0.9	
200 RB 6	27.3	29.5	18.9	28.0	33.0	20.1	20.6	17.8	29.4	28.7	1.6	
240 RA 8	36.3	39.3	25.2	37.3	43.9	26.8	27.4	23.8	39.2	38.3	2.3	
240 RA 9	76.2	82.5	52.9	78.4	92.2	56.3	57.6	49.9	82.3	80.4	4.8	
240 RA 12	85.7	92.8	59.5	88.1	103.7	63	65	56	93	90	5.4	
240 RA 16	139.1	150.5	96.5	142.9	168.2	103	105	91	150	147	8.8	
240 RA 20	202.6	219.3	140.7	208.3	245.2	150	153	133	219	214	12.8	

Type	Nominal Capacity Q_n (kW)										Kv-Value m_3/h	Δp Min Bar
	Hot Gas											
	R134a	R22	R404A R507	R407C	R450A	R513A	R1234ze	R448A	R449A			
110 RB 2	1.6	2.0	1.7	2.1	1.4	1.5	1.3	2.0	2.0	0.2	0.05	
200 RB 3	3.0	3.7	3.2	3.9	2.9	3.0	2.6	4.0	4.0	0.4		
200 RB 4	7.1	8.8	7.5	9.2	6.5	6.8	5.8	9.1	9.0	0.9		
200 RB 6	12.5	15.4	13.1	16.1	11.6	12.1	10.4	16.2	15.9	1.6		
240 RA 8	16.7	20.5	17.4	21.4	16.6	17.3	14.9	23.2	22.9	2.3		
240 RA 9	35.1	43.1	36.5	44.9	34.7	36.2	31.1	48.5	47.8	4.8		
240 RA 12	39.4	48.4	41.1	50.5	39.0	40.7	35.0	54.5	53.8	5.4		
240 RA 16	64.0	78.5	66.6	81.9	63.5	66.3	57.0	88.9	87.6	8.8		
240 RA 20	93.2	114.4	97.1	119.3	92.4	96.4	82.9	129.3	127.5	12.8		

Type	Nominal Capacity Q_n (kW)										Kv-Value m_3/h	Δp Min Bar
	Suction Gas											
	R134a	R22	R404A R507	R407C	R450A	R513A	R1234ze	R448A	R449A			
240 RA 8	4.2	5.6	4.6	5.2	3.7	4.0	3.4	5.1	5.0	2.3	0.05	
240 RA 9	8.8	11.7	9.7	10.9	7.8	8.4	7.1	10.6	10.5	4.8		
240 RA 12	9.9	13.1	10.9	12.3	8.8	9.4	8.0	11.9	11.8	5.4		
240 RA 16	16.0	21.3	17.7	19.9	14.3	15.3	13.1	19.4	19.2	8.8		
240 RA 20	33.0	31.0	25.7	29.0	20.8	22.3	19.0	28.3	27.9	12.8		

Nominal Capacities at +38°C Condensing Temperature, +4°C Evaporating Temperature, Subcooling 1 K, Superheat 0K. 0.15 Bar Pressure Drop Between Valve Inlet and Outlet in Liquid Applications. 1 Bar Pressure Drop for Hot Gas Applications. +18 °C Suction Gas Temperature. Note: See "Controls Navigator" for Selection

Selection Guide

Type		Part No.	Connection Solder / ODF	
			mm	Inch
110 RB 2	T2	801 217	6	
	T2	801 210		1/4
	T3	801 209	10	
200 RB 3	T3	801 239	10	
200 RB 4	T3	801 176	10	
	T3	801 190		3/8
	T4	801 178	12	
	T4	801 179		1/2
200 RB 6	T4	801 182	12	
	T4	801 183		1/2
	T5	801 186	16	5/8
240 RA 8	T5	801 160		5/8
	T7	801 143	22	7/8
240 RA 9	T5	801 161	16	5/8
	T7	801 162	22	7/8
	T9	801 142		1-1/8
240 RA 12	T7	801 163	22	7/8
	T9	801 144		1-1/8
240 RA 16	T9	801 164		1-1/8
	T11	801 166	35	1-3/8
240 RA 20	T11-M	801 172	35	1-3/8
	T13-M	801 224	42	
	T13-M	801 173		1-5/8
	T17-M	801 174	54	2-1/8

Special Versions:

- Manual stems standard on Series 240 RA 20.

Options:

- Actuation coils available for various voltages, see 'Coils ASC and Cable Assemblies'

2-Way Solenoid Valves Series 540

Normally Closed

Features

- Compact size
- No disassembly necessary for soldering



540 RA

Accessories

- Actuation coil and cable assemblies available for various voltages, see 'Coils ASC3 and Cable Assemblies'

Capacity Data

Type	Nominal Capacity Q_n (kW)												Kv-Value m^3/h	Δp Min Bar
	Liquid				Hot Gas				Suction Gas					
	R134a	R22	R404A R507	R407C	R134a	R22	R404A R507	R407C	R134a	R22	R507	R407C		
540 RA 8	36.3	39.3	25.2	37.3	16.7	20.5	17.4	21.4	4.2	5.6	4.6	5.2	2.3	0.05
540 RA 9	76.2	82.5	52.9	78.4	35.1	43.1	36.5	44.9	8.8	11.7	9.7	10.9	4.8	0.05
540 RA 12	85.7	92.8	59.5	88.1	39.4	48.4	41.1	50.5	9.9	13.1	10.9	12.3	5.4	0.05
540 RA 16	139.1	150.5	96.5	142.9	64.0	78.5	66.6	81.9	16.0	21.3	17.7	19.9	8.8	0.05
540 RA 20	202.6	219.3	140.7	208.3	93.2	114.4	97.1	119.3	23.3	31.0	25.7	29.0	12.8	0.05

Nominal Capacities at +38°C Condensing Temperature. +4°C Evaporating Temperature. 0.15 Bar Pressure Drop Between Valve inlet and Outlet in Liquid Applications (For Hot Gas Applications 1 Bar Pressure Drop and +18 °C Suction Gas Temperature); Subcooling 1 K. Correction Tables for Other Operating Conditions See Correction Tables for 110 RB, 20 RB, 240 RA and 540 RA.

Note: See "Controls Navigator" for selection

Selection Guide

Type	Part No.	Connection Solder / ODF	
		mm	Inch
540 RA 8	T5	046 265	5/8
540 RA 9	T5	046 266	5/8
	T7	046 268	7/8
540 RA 12	T7	046 269	7/8
540 RA 16	T9	046 270	1-1/8
540 RA 20	T11	047 953	1-3/8

Options:

- Actuation coils available for various voltages, see 'Coils ASC and Cable Assemblies'

Accessories and Spare Parts for Solenoid Valves

Gasket Kits

Description	Type	Part No.
110RB	KS 30040-2	801 232
200RB	KS 30039-1	801 233
240RA8	KS 30061-1	801 234
240RA9/12	KS 30062-1	801 235
240RA16	KS 30065-1	801 236
240RA20	KS 30097-1	801 237

Description	Type	Part No.
Service tool for 110 RB, 240 RA, 540 RA	X 11981 - 1	027 451

Repair Kits

Description	Type	Part No.
110RB	KS 30040-1	801 206
200RB	KS 30039/ KS 30109	801 205
240RA8	KS 30061	801 262
240RA9	KS 30062	801 263
240RA12	KS 30063	801 264
240RA16	KS 30065	801 200
240RA20	KS 30097	801 216

2-Way Solenoid Valves Series 200 RH for High Pressure Applications

Normally Closed

Features

- Compact size
- Media Temperature Range -40 to +120 °C
- No disassembly necessary for soldering
- Extended copper tubes for easy installation
- No disassembly necessary for brazing
- IP 65 Solenoid coil and cable assembly
- One coil fits to all sizes and valve series
- PS: 60 bar



Accessories

- Actuation coil and cable assemblies available for various voltages, see 'Coils ASC3 and Cable Assemblies'

Capacity Data

Type	Nominal Capacity Q _n (kW)			
	Liquid		Hot Gas	
	R410A	R744	R410A	R744
200 RH 3	8.3	11.6	4.7	6.9
200 RH 4	19.6	27.5	10.5	15.5
200 RH 6	34.4	48.3	18.7	27.6

R410A: Nominal capacities at +38°C condensing temperature, +4°C evaporating temperature, subcooling 1 K
0.15 bar pressure drop between valve inlet and outlet in liquid applications.
1 bar pressure drop for hot gas applications

R744: Nominal capacities at +10°C condensing temperature, -10°C evaporating temperature, subcooling 1 K
0.15 bar pressure drop between valve inlet and outlet in liquid applications.
1 bar pressure drop for hot gas applications

Note: See "Controls Navigator" for selection

Selection Guide

Type	Part No.	Connection Solder / ODF	
		mm	Inch
200 RH 3	T3 802 070	10 mm	3/8"
200 RH 4	T3 802 071	10 mm	
	T3 802 072		3/8"
	T4 802 073	12 mm	
	T4 802 074		1/2"
200 RH 6	T4 802 075	12 mm	
	T4 802 076		1/2"
	T5 802 077	16 mm	5/8"

Options:

- Actuation coils available for various voltages, see '2-Way Solenoid Valves coils ASC3'

3-Way Solenoid Valves Series M36

Features

- For heat reclaim application
- Pilot connection to suction line required. no minimum pressure drop
- Compact size
- No disassembly necessary for brazing
- Max. allowable pressure PS: 35 bar

Accessories

- Actuation coil and cable assemblies available for various voltages, see 'Coils ASC3 and Cable Assemblies



M36-118



M36-078 with ASC3 Coil and DS2 Chopper Plug

Capacity Data

Type	Part No.	Connection Solder/ODF		Nominal Capacity Q _n (kW)				kv-Value m ₃ /h	Coil Type
		mm	Inch	R134a	R22	R404A / R507	R407C		
M36-078	801 420	22	7/8	28.9	35.1	31.3	38.5	6.7	ASC3
M36-118	801 421		1-1/8						

Nominal Capacities at +38°C Condensing Temperature, +4°C Evaporating Temperature (Saturated Pressures / Dew Point), 0.15 Bar Pressure Drop Between Valve Inlet and Outlet.





Mechanical Pressure Regulators

Basic Terms and Technical Information

Capacity Regulators

Regulator series ACP and CPHE are hot gas bypass regulators and serve the purpose of compensating excess compressor capacity. Thus they prevent the generation of evaporator pressures below predetermined levels.

In case of hot gas injection into the suction line, a liquid injection valve in conjunction with a solenoid valve is required to desuperheat the excessively hot suction gas. The capacity should not be reduced below 60% of maximum in this application to avoid oil return problems.

With hot gas injection at the evaporator inlet, no liquid injection valve is necessary. The injection must be such that the incremental gas volume is taken into account. No problems with oil return should be expected even when regulating 100% of capacity.

Evaporator Pressure Regulators

Series PRE regulators serve the purpose of maintaining evaporator pressure above certain predetermined levels. The most important application is the use of several evaporators with different evaporating temperatures in conjunction with a common suction line.

The freezing of water in water chillers and air conditioning systems can be safely prevented if evaporating temperatures are kept above 0°C, even when loads are greatly reduced.

Crankcase Pressure Regulators

Series PRC regulators serve the purpose of preventing excessively high suction pressures to protect compressor motors from overloading.

Excessively high suction pressures can occur at start-up of a refrigeration circuit in case of high loads and after defrost. Crankcase regulators are adjusted to the maximum allowed suction pressure rating of the compressors as given by the compressor manufacturers.

Selection Guide for Pressure Regulators

Selection Criteria	Series			
	ACP	CPHE	PRE	PRC
Capacity Regulator	+	+		
Evaporator Pressure Regulator			+	
Crankcase Pressure Regulator				+



Hot Gas Bypass Regulators Series ACP

Features

- High-quality materials and processes for high reliability and long lifetime
- Internal equalization
- Compact size

Technical Data

Adjustment Range	0 ... 5 bar
Factory Setting	2.7 bar
Max. Allowable Pressure PS	31 bar
Medium Temperature Range TS	-40°C ... 120°C
Ambient Temperature Range	-40 ... 50°C
Transport Temperature Range	-40 ... 70°C



ACP

Capacity Data

Type	Part No.	Connection, Angle Solder/ ODF inch	Nominal Bypass Capacity* Q _n			
			R134a	R22	R407C	R404A / R507
ACP 1	047 680	1/4 x 3/8"	0.21	0.35	0.41	0.30
ACP 3	047 283	1/4 x 3/8"	0.50	0.77	0.89	0.68
ACP 5	053 374	3/8 x 3/8"	1.18	1.83	2.12	1.59

* Nominal capacities at +38°C condensing temperature, +4°C evaporating temperature (saturated temperatures / dew point) and 1 K liquid subcooling at the inlet of the expansion valve.

Hot Gas Bypass Regulators Series CPHE

Features

- High-quality materials and processes for high reliability and long lifetime
- Superior partial load performance due to double seat orifice design (CPHE3 to CPHE6)
- Modular design for economical logistics and easy assembly and servicing
- External equalization

Specific connection sizes and flanges available on request.

For selection see last page of “Thermo-Expansion Valves” chapter.

Technical Data

Adjustment Range	-0.4 ... 5 Bar
Factory Setting	1.4 Bar
Max. Allowable Pressure PS	35 Bar
Medium Temperature Range TS	-40°C ... 120°C
Ambient Temperature Range	-40 ... 50°C
Transport Temperature Range	-40 ... 70°C



Capacity Data CPHE

Type	Nominal Bypass Capacity Q _n kW									Orifice	Standard Flange Solder/ODF		Power Assembly
	R134a	R22	R407C	R404A/ R507	R450A	R513A	R448A	R449A	R1234ze		mm	Inch	
CPHE - 1X	3.5	5	5.8	4.5	3.4	2.6	5.9	5.8	3.1	X 22440-B5B	C 501 - 7 mm 12 x 16	C 501 - 7 1/2 x 5/8	X7818 - 1
CPHE - 2X	6.4	9	10.4	8.1	6.2	4.8	10.6	10.5	5.6	X 22440-B8B	A 576 mm 16 x 22 (22 x 280 ODM)	A 576 5/8 x 7/8 (7/8 x 1-1/8 ODM)	
CPHE - 3X	12	17	20	15	12	9	20	20	10	X 11873-B5B	10331 22 x 22	10331 7/8 x 7/8 (1-1/8 x 1-1/8 ODM)	
CPHE - 3.5X	13	19	22	17	13	10	22	22	12	X 9117-B7B	9153 mm 22 x 22	9153 7/8 x 7/8	
CPHE - 4X	16	23	27	21	16	12	27	26	14	X 9117-B9B			
CPHE - 5X	21	29	34	26	20	15	35	34	18	X 9166-B10B	9149 22 x 22	9149 7/8 x 7/8	
CPHE - 6X	35	50	58	45	34	26	59	58	31	X 9144-B13B			

Nominal Capacities at +38°C Condensing Temperature, +4°C Evaporating Temperature (Saturated Temperatures / Dew Point) and 1 K Liquid Subcooling at the Inlet of the Expansion Valve.

Specific Connection Sizes and Flanges Available on Request. For Selection, See Last Page of “Thermo-Expansion Valves” Chapter.

Note: See “Controls Navigator” for Selection

Evaporator and Crankcase Pressure Regulator Series PRE and PRC

Features

- Compact design permits minimal space requirements
- Schrader valve on inlet for ease of setting
- Direct operated regulator
- Balanced port design provides accurate pressure control
- Copper tubes for easy soldering



Technical Data

Refrigerants	HFC, HCFC
Oil Compatibility	Mineral, Alkyl Benzene and Polyol-Ester (POE) Lubricants
Max. Allowable Pressure PS Max. Test Pressure PT	25 Bar 30 Bar
Material Housing	CW509L (EN12420)
Temperature Range	Storage -30°C to 80°C Medium TS -30°C to 80°C Ambient -30°C to 80°C

Pressure Change Per Turn: Valve Size 1 Valve Size 2	0.6 Bar 0.4 Bar
Pressure Range Factory Setting	0.5 to 6.9 Bar 2 Bar
Weight: PRC/PRE-1.. PRC/PRE-2..	0.6 kg 1.3 kg

Evaporator Pressure Regulator Series PRE

Selection

Type	Part No.	Tube Connection ODF	Nominal Capacity* Q _n (kW)			
			R134a	R404A / R507	R407C	R22
PRE - 11A	800 380	16 mm - $\frac{5}{8}$ "	3.0	4.5	4.5	4.8
PRE - 11B	800 381	22 mm - $\frac{7}{8}$ "				
PRE - 21C	800 382	28 mm	7.4	11.1	11.1	11.9
PRE - 21D	800 383	1 - $\frac{1}{8}$ "				

*Nominal Capacities are Based on Evaporating Temperature +4°C, Condensing Temperature +38°C and a Pressure Drop of 1K.

Crankcase Pressure Regulator Series PRC

Selection

Type	Part No.	Tube Connection ODF	Nominal Capacity* Q _n (kW)			
			R134a	R404A / R507	R407C	R22
PRC - 11A	800 384	16 mm - 5/8"	3.0	4.5	4.5	4.8
PRC - 11B	800 385	22 mm - 7/8"				
PRC - 21C	800 386	28 mm	7.4	11.1	11.1	11.9
PRC - 21D	800 387	1 - 1/8"				
PRC - 21E	800 388	35 mm - 1-3/8"				

*Nominal Capacities are Based on Evaporating Temperature +4°C and Condensing Temperature +38°C and a Pressure Drop of 1 K.

Capacity Table

Selection for Operating Conditions Other Than +38°C / +4°C and 1 K Liquid Subcooling at the Inlet of the Valve: (Capacities are Based on a Pressure Drop of 0.07 Bar).

Refrigerant	Evaporating Temperature °C	Capacity (kW) Valve Setting °C													
		Valve Size 1: PRC-11x							Valve Size 2: PRC-21x						
		-20	-15	-10	-5	0	+5	+10	-20	-15	-10	-5	0	+5	+10
R22	-29	2.3	3.4	4.4	4.8	4.9			5.8	8.8	10.0	10.0	10.0		
	-21		2.4	4.1	5.4	5.8				6.5	12.1	12.1	12.1		
	-14			2.7	4.9	6.2					8.1	13.8	13.8		
	-8				3.5	5.3						9.0	15.4		
	-3					3.1							9.9		
R407C	-6				3.1	4.8						7.9	13.9		
	-1					2.9							9.2		
R134 a	-6					2.1	3.9	5.3					5.2	10.3	12.9
	1						2.4	4.7						6.1	12.2
	7							3.3							8.1
R404A / R507	-27	1.6	2.9	3.7	3.9				4.8	8.2	8.2	8.2			
	-20		1.9	3.5	4.5					5.7	9.8	9.8			
	-14			2.2	4.5						6.8	11.6			
	-10				3.1							8.1			



Pressure Controls and Thermostats

Pressure Controls

Basic Terms and Technical Information

Characteristics

Pressure controls serve various functions, which may be divided into control and protection functions. Examples for control functions are compressor cycling, pump-down or defrost control. Protection functions include pressure limiting and cut-out against excessive pressures, against loss of charge or for freeze protection.

These functions are performed by operating a set of electrical contacts when exceeding a preset lower or upper pressure limit. Depending on whether they are type tested (TÜV approved) or not, they may be referred to by the following terms:

without TÜV approval:	Pressure Control
with TÜV approval:	Pressure Limiter, Pressure Cut-Out or Safety Pressure Cut-Out

Pressure controls with TÜV approval are tested according to EN 12263 as required by DIN 8901 and EN 378.

- 1. Pressure Controls (Without TÜV Approval)**
Pressure controls without type approval may either be of the automatic or manual reset type. Manual reset versions are available for decreasing (manual reset min.) or increasing pressure (manual reset max.).
- 2. Pressure Limiters PSL/PSH**
Pressure limiters are of the automatic reset type. Limiters for high pressure applications have a double bellows design to act as fail-safe controls.
- 3. Pressure Cut-outs PZH/PZL**
Pressure cut-outs are of the manual reset type where reset is possible from the outside of the control without the need for a tool (external reset). Cut-outs for high pressure applications have a double bellows design to act as fail-safe controls.
- 4. Safety Pressure Cut-outs PZHH/PZLL**
Pressure cut-outs are of the manual reset type where the reset requires the use of a tool. Typically, the removal of a cover is required in order to press the reset button (internal reset). Cut-outs for high pressure applications have a double bellows design to act as fail-safe controls.

Adjustment of Switching Points

A pressure gauge should always be used for comparison when adjusting the switching points on pressure controls. The setting scale on the

device is intended to serve for orientation, showing the setting range of the upper switching point p_{max} in bar/psig and the value of the pressure differential Δp as difference between upper switching point p_{max} and the lower switching point p_{min} . The upper switching point p_{max} has to be adjusted on the scale, whereas the lower switching point p_{min} is given by adjustment of the desired switching differential Δp .

The formula is:

$$\text{Upper switching point} - \text{Differential} = \text{Lower switching point}$$

$$P_{max} - \Delta p = P_{min}$$

Function of Contacts SPDT

On pressure rise above setting 1-2 opens and 1-4 closes. On pressure drop below setting 1-2 closes and 1-4 opens.

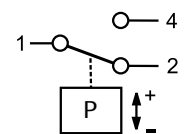

SPDT With Manual Reset Max.

On pressure rise above setting 1-2 opens and 1-4 closes and latches. The device can be manually reset when the pressure has dropped below setting.

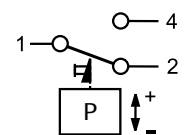

SPDT With Manual Reset Min.

On pressure drop below setting 1-2 closes, 1-4 opens and latches. The device can be manually reset when the pressure has risen above setting.

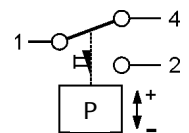

Unit of Pressure

All pressures are given in gauge pressure

$$P_{absolute} = P_{gauge} + 1 \text{ bar}$$

$$1 \text{ bar} = 100 \text{ kPa}$$

$$1 \text{ bar} = 14.5 \text{ psi}$$

Pulsation Damping

All high pressure controls with connection ($\frac{7}{16}$ -20UNF, $\frac{1}{4}$ " SAE male) are equipped with a snubber to protect the pressure element from pulsations.



Standards and Regulations

BGV D4 (VBG20)	Accident Prevention Regulations for Refrigeration Plant.
DIN 8901	Heat Pumps with Fluorocarbon Refrigerants. Protection of Soil, Underground and Surface Water.
EN 60947-1/ EN 60947-5-1	Specifications for Low-Voltage Switch Gear.
EN 378	Refrigerating Systems and Heat Pumps - Safety and Environmental Requirements.
EN 12263	Refrigerating Systems and Heat Pumps - Safety Switching Devices for Limiting the Pressure Requirements and Tests.

Selection Guide for Pressure Controls

Series	Selection Criteria					
	Design	Number of Contacts (SPDT)	Adjustable	Protection DIN 40050 IEC 529	Rated Operational Current at 230 V AC	
					Inductive Amp. AC 15	Motor Rating UL
PS1	Pressure Control (single packaging) Model	1	yes	IP 44	10 A	24 A
PS2	Dual Pressure Control (single packaging)	1+1	yes	IP 44	10 A	24 A
PS3	Pressure Controls Standard types (single packaging)	1	Factory set to fixed values	IP 30 / IP 65	3 A	6 A
	Pressure Control Special types (100 pieces packaging)	1	Other fixed values acc. to agreed specification	IP 30 / IP 65	3 A	6 A
CS3 (for CO2 Applications)	Pressure Controls Standard types (60 pieces packaging)	1	Factory set to fixed values	IP 30 / IP 65	3 A	6 A
	Pressure Control Special types (60 pieces packaging)	1	Other fixed values acc. to agreed specification	IP 30 / IP 65	3 A	6 A
PS4	Pressure Controls standard types (100 pieces packaging)	1	Factory set to fixed values	IP67 (cable) IP20 (terminals)	6 A	6 A
FD 113	Differential Pressure Control	1	yes pressure diff. + time delay	IP 30	3 A / 6 A	-

Pressure Controls Series PS1 / PS2

Features

- Adjustable pressure setpoint
- Automatic and manual reset versions
- Flare and solder pressure connections
- Chatter-resistant (bounce-free) contacts
- High operational current, locked rotor max. 144 A (LRA)
- Standard SPDT with same operational current rating for both contacts
- Dual pressure control with independent SPDT switches (single pole double throw) for high and low pressure side
- Locking plate and mounting screws included

Options (minimum order quantity 100 pieces)

- Convertible reset to reduce stock
- Other types of pressure connections upon agreement
- Factory set to customer specification



Standards

- per Low Voltage Directive
- per PED Directive. TÜV appr. versions only
- Underwriter Laboratories (File Nr. E85974)
- German Lloyd for use on ships, only when used with marine cable glands (accessory)

Selection Table Single Pressure Controls PS1

Type	Part No.	Adjustment Range		Lowest Setpoint bar	Factory Setting bar	Leakage Test Pressure bar	Pressure Connection
		Upper Setpoint	Differential bar				
Low Pressure Controls							
PS1-A3A	4 370 700	-0.5 ... 7	0.5 ... 5	-0.9	3.5 / 4.5	24	$\frac{7}{16}$ "-20 UNF
PS1-A3U	4 712 201						solder tube 6 mm
PS1-A3X	4 713 430						solder tube $\frac{1}{4}$ "
PS1-R3A	4 350 100	-0.5 ... 7	External Reset Approx. 1 Bar Above Setpoint	-0.9	3.5	24	$\frac{7}{16}$ "-20 UNF
High Pressure Controls							
PS1-A5A	4 350 500	6 ... 31	2 ... 15	3	16 / 20	35	$\frac{7}{16}$ "-20 UNF
PS1-A5L	4 715 136						cap./solder tube $\frac{1}{4}$ "
PS1-A5U	4 713 325						solder tube 6 mm
PS1-A5X	4 713 434						solder tube $\frac{1}{4}$ "
PS1-R5A	4 350 700	6 ... 31	Ext. Manual Reset Approx. 3 Bar Below Setpoint	-	20	35	$\frac{7}{16}$ "-20 UNF

Selection Table Single Pressure Controls PS1 TÜV (EN 12263)

Type	Part No.	Adjustment Range		Lowest Setpoint bar	Factory Setting bar	Leakage Test Pressure bar	Pressure Connection
		Upper Setpoint bar	Differential bar				
Pressure Limiter for Low Pressure Protection PSL - Automatic Reset							
PS1-W3A	4 368 300	-0.5 ... 7	0.5 ... 5	-0.9	3.5 / 4.5	24	7/16"-20 UNF
PS1-W3U	4 713 437						solder tube 6 mm
Pressure Cut Out for Low Pressure Protection PZL - External Manual Reset							
PS1-B3A	4 470 400	-0.5 ... 7	Reset Approx. 1 Bar Above Setpoint	-0.9	3.5	24	7/16"-20 UNF
PS1-B3U	4 715 141						solder tube 6 mm
Pressure Limiter for High Pressure Protection PSH - Automatic Reset							
PS1-W5A	4 353 200	6 ... 31	2 ... 15	3	16 / 20	35	7/16"-20 UNF
PS1-W5U	4 713 439						solder tube 6 mm
Pressure Cut Out for High Pressure Protection PZH - External Manual Reset							
PS1-B5A	4 353 300	6 ... 31	Reset Approx. 3 Bar Below Setpoint	-	20	35	7/16"-20 UNF
PS1-B5U	4 712 332						solder tube 6 mm
Safety Pressure Cut Out for High Pressure Protection PZHH - Internal Manual Reset (with tool)							
PS1-S5A	4 368 400	6 ... 31	Reset Approx. 3 Barb Below Setpoint	-	21	35	7/16"-20 UNF
PS1-S5U	4 711 591						solder tube 6 mm

Technical Data PS1 / PS2

Type of Contacts	- PS1: 1 x SPDT contact - PS2: 2 x SPDT contacts
Resistive load (AC1) Inductive load (AC15) Inductive load (DC 13)	24A / 230V AC 10A / 230V AC 0.1A / 230V DC 3A / 24V DC 6A / 12V DC
Motor rating UL (FLA) Startup / Locked Rotor UL	24A / 120 / 240V AC 144A / 120 / 240V AC

Medium Compatibility	HFC, HCFC, HFO/HFO Blends (refrigerant safety group A1)
Protection Acc. EN 60529 / IEC 529	IP 44
Ambient Temperature Range Max. Temperature at Pressure Connection	-50°C .. +70°C +70°C
Cable Entry	Grommet PG 16
Locking Device	Blocking Plate
Mounting Screws	M4 / UNC 8-32

Dual Pressure Controls Series PS2



PS2

Selection Table Dual Pressure Controls PS2

Type	Part No.	Adjustment Range				Factory Setting		Leakage Test Pressure		Pressure Connection
		Upper Setpoint		Differential		Left Bar	Right Bar	Left Bar	Right Bar	
		Left Bar	Right Bar	Left Bar	Right Bar					
Combined Low and High Pressure Controls (automatic and manual reset)										
PS2-A7A	4 353 400									7/16"-20 UNF
PS2-A7U	4 713 415	-0.5 ... 7	6 ... 31	0.5* ... 5	ca. 4 fix	3.5 / 4.5	20	24	35	solder tube 6 mm
PS2-A7X	4 713 416									solder tube 1/4"
PS2-L7A	4 351 100									7/16"-20 UNF
PS2-L7U	4 713 417	-0.5 ... 7	6 ... 31	0.5* ... 5	external manual reset approx. 4 bar under setpoint	3.5 / 4.5	20	24	35	solder tube 6 mm
PS2-R7A	4 351 300									7/16"-20 UNF
PS2-R7U	4 713 419	-0.5 ... 7	6 ... 31	0.5* ... 5	external manual reset approx. 1 bar above setpoint external manual reset approx. 4 bar below setpoint	3.5	20	24	35	solder tube 6 mm
Combined Low and High Pressure Controls, High Side Convertible from Automatic to Manual Reset										
PS2-M7A	4 361 300	-0.5 .. 7	6 ... 31	0.5* ... 5	-	3.5 / 4.5	21	24	35	7/16"-20 UNF

Selection Table - Dual Pressure Controls PS2 TÜV (EN12263)

Type	Part No.	Adjustment Range				Factory Setting		Leakage Test Pressure		Pressure Connection
		Upper Setpoint		Differential		Left Bar	Right Bar	Left Bar	Right Bar	
		Left Bar	Right Bar	Left Bar	Right Bar					
Combined Pressure Limiter for Low Pressure / High Pressure protection EN 12263 PSL / PSH (Automatic / Automatic)										
PS2-W7A	4 360 100									7/16"-20 UNF
PS2-W7L	4 450 300	-0.5 ... 7	6 ... 31	0.5* ... 5	ca. 4 fix	3.5 / 4.5	20	24	35	cap./solder 1/4"
PS2-W7U	4 712 436									Solder 6 mm
Combined Pressure Limiter / Pressure Cut-Out for Low Pressure / High Pressure Protection PSL / PZH (Automatic / External Manual Reset)										
PS2-C7A	4 353 500	-0.5 ... 7	6 ... 31	0.5* ... 5	external manual reset approx. 4 bar below setpoint	3.5 / 4.5	20	24	35	7/16"-20 UNF
Combined Pressure Limiter Safety Pressure Cut Out for Low Pressure / High Pressure Protection EN 12263 PSL / PZH (Automatic / Automatic Convertible to External Manual Reset)										
PS2-N7A	4 715 756	-0.5 .. 7	6 ... 31	0.5* ... 5	-	3.5 / 4.5	21	24	35	7/16"-20 UNF

Note: *) Lowest Possible Setpoint: -0.9 Bar

Selection Table - Dual Pressure Controls PS2 TÜV (EN12263)

Type	Part No.	Adjustment Range				Factory Setting		Leakage Test Pressure		Pressure Connection
		Upper Setpoint		Differential		Left Bar	Right Bar	Left Bar	Right Bar	
		Left Bar	Right Bar	Left Bar	Right Bar					
Combined Pressure Limiter / Safety Pressure Cut-Out for Low Pressure / High Pressure Protection PSL / PZHH - Automatic / Internal Manual Reset										
PS2-T7A	4 368 500	-0.5 ... 7	6 ... 31	0.5* ... 5	Internal Reset Approx. 4 Bar Below Setpoint	3.5 / 4.5	21	24	35	$7/16$ "-20 UNF
PS2-T7U	4 713 424									solder tube 6 mm
Combined Pressure Cut-Out for Low Pressure / High Pressure Protection PZL / PZH External Manual Reset / External Manual Reset										
PS2-B7A	4 360 200	-0.5 ... 7	6 ... 31	External Reset Approx. 1 Bar Above Setpoint	Internal Reset Approx. 4 Bar Below Setpoint	3.5	20	24	35	$7/16$ "-20 UNF
PS2-B7U	4 449 400									solder tube 6 mm
Combined Pressure Cut-Out / Safety Pressure Cut-Out for High Pressure Protection PZH / PZHH External Manual Reset / External Manual Reset										
PS2-G8A	4 368 600	6 ... 31	6 ... 31	External Manual Reset Approx. 4 Bar Below Setpoint	Internal Manual Reset Approx. 4 Bar Below Setpoint	20	21	35	35	$7/16$ "-20 UNF
PS2-G8U	4 713 427									solder tube 6 mm
PS2-G8X	4 713 428									Solder $1/4$ "

Note: *) Lowest Possible Setpoint: -0.9 Bar

Accessories

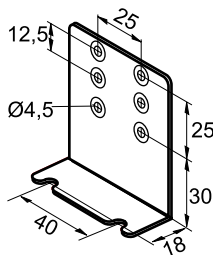

Mounting
Bracket Angle
Part No.: 803 799

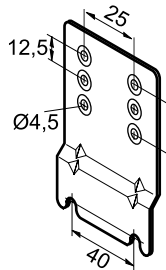

Mounting Plate for
Units with Hood
Part No.: 803 801

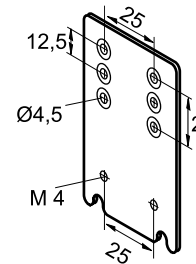

Extension Bracket
Part No.: 803 800

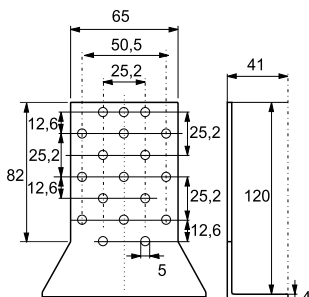

Universal
Mounting
Bracket
Part No.: 803 798

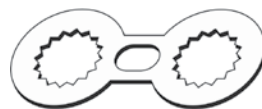

Locking Plate
Part No.: 803783 (20 pcs)

Copper Gasket Set for R $1/4$ "
($7/16$ "-20 UNF, Female)
100 pcs Package
Part No.: 803 780

Pressure Controls Series PS3 / Standard Types

Fixed Settings in Single Packaging



Features

- Maximum allowable pressure up to 45 bar / test pressure up to 50 bar
- High and low pressure switches
- High temperature version with snubber for direct compressor mounting (range 6)
- Direct mounting reduces the number of joints and thus avoiding potential leakage
- Precise setting and repeatability
- IP 65 protection if used with PS3-Nxx cables with plug (acc. EN 175301-803), no additional gasket required (molded into plug)
- Cables with plug to be ordered separately



PS3

Standards

-  per Low Voltage Directive
-  per PED Directive, TÜV appr. versions only
-  Underwriter Laboratories (File No. E85974) (Released for 43 bar)

Selection Table PS3- Standard Types

Pressure Control Type	Part No.	Fixed setting		Reset	Max. Temperature		Leakage Test Pressure (bar)	Pressure Connection
		Cut-out (bar)	Cut-in (bar)		Ambient (°C)	Pressure Connection (°C)		
High Pressure Controls								
PS3-A6S	0 715 603	16.0	11.0	Auto	+70	+150	50	7/16"-20UNF Female Thread with Schrader Opener
PS3-A6S	0 715 604	19.0	15.0					
PS3-A6S	0 715 600	26.5	22.5					
Low Pressure Controls / Pressure Limiter for Low Pressure Protection PSL TÜV / EN 12263								
PS3-W1S	0 714 760	-0.3	1.2	Auto	+70	+70	30	7/16"-20UNF Female Thread with Schrader Opener
PS3-W1S	0 714 761	0.3	1.8					
PS3-W1S	0 714 762	2.0	3.5					
Pressure Limiter for High Pressure Protection PSH with snubber for direct compressor mounting TÜV / EN 12263								
PS3-W6S	0 715 831	14.0	10.0	Auto	+70	+150	50	7/16"-20UNF Female Thread with Schrader Opener and Snubber
PS3-W6S	0 715 556	21.0	16.0					
PS3-W6S	0 715 555	25.0	20.0					
PS3-W6S	0 715 567	29.0	23.0					
PS3-W6S	0 715 550	33.5	27.5					
PS3-W6S	0 715 553	40.0	33.0					
Pressure Cut-Out for High Pressure Protection PZH with Snubber for Direct Compressor Mounting TÜV / EN 12263								
PS3-B6S	0 715 568	19.2	Approx. 5 Bar Below Cut-out	External Manual Reset	+70	+150	50	7/16"-20UNF Female Thread with Schrader Opener and Snubber
PS3-B6S	0 715 564	22.7						
PS3-B6S	0 715 563	27.3						
PS3-B6S	0 715 569	29.5						
PS3-B6S	0 715 560	36.0						

Accessories Cable Assemblies

Temperature Range	Type	Part No.	Length (mtr.)	Leads
-50...80°C / No UL	PS3-N15	804 580	1.5	3 x 0.75 mm ²
	PS3-N30	804 581	3.0	
	PS3-N60	804 582	6.0	



Plug According to EN 175301	Part No.
PG9	801 012
PG11	801 013

Technical Data

Protection According to EN 60529 / IEC 529	IP 00 IP 30 with Terminal Cover IP 65 with PS3-Nxx Cables with Plug or Plug DIN 43650
Inductive load (AC15)	3A / 230V AC
Inductive load (DC)	0.1A / 230V DC
Motor rating amps (FLA)	6A / 120/240V AC
Lock rotor amps (LRA)	36A / 120/240V AC

*Note: For high temperature applications, i. e., medium temperatures between 70 °C and 150 °C, the maximum ambient temperature must be derated as per drawing. E.g.: on medium temperature 120 °C the ambient temperature of 55 °C around the switch housing should not be exceeded.

Temperature Range TS * Ambient. Storage and Transportation Medium	-40 °C .. 70 °C -40 °C .. 70 °C (150°C Range 6)
Pressure Range PS	- 0.6 .. 43 Bar
Type of Contacts	1 SPDT
Medium Compatibility	HFC, HCFC, HFO/HFO Blends (refrigerant safety group A1)

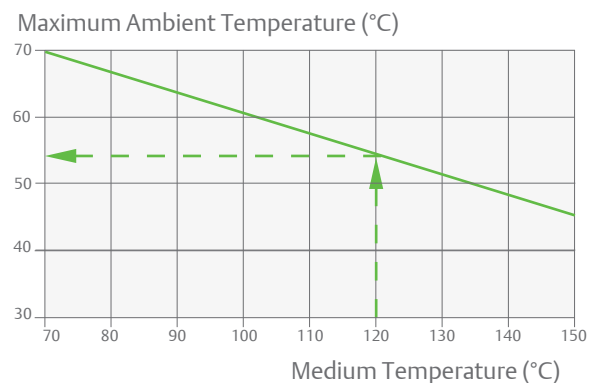

Pressure Controls Series PS3/PSC Special Types

According to Agreed Specification, 100 Pieces Packaging

Features

- Maximum allowable pressure up to 45 bar / test pressure up to 50 bar
- For direct mounting on a pressure connection (free standing) or with a capillary tube
- Direct mounting reduces the number of joints and thus avoids potential leakage
- Direct mounting saves cost for flexible hose and additional fittings
- Precise setting and repeatability
- High temperature version with snubber, for direct compressor mounting (range 6)
- Micro switch for narrow pressure differentials
- Gold plated contacts for low voltage / current applications
- Worldwide approvals
- Easy mounting
- Housing with integrated console for free-standing installation
- Low pressure switch with automatic or manual reset
- High pressure switch with automatic or manual reset, standard or high temperature version
- Pressure limiter PSH - standard or high temperature version
- Pressure cut-out PZH - external reset, standard or high temperature version
- Safety pressure cut-out PZHH - internal reset, standard or high temperature version
- Cables with plug in lengths of 1.5m, 3.0m and 6.0m available. No additional gasket required.
- Appliance socket DIN 43650
- Electrical contact single pole double throw
- Electrical micro switch single pole double throw (SPDT)
- Gold plated contacts upon request



Standards

- per Low Voltage Directive
- per PED Directive TÜV appr. versions only
- Underwriter Laboratories (File No. E85974) (Released for 43 bar)

Pressure Connections

- S: $\frac{7}{16}$ " -20UNF, female with Schrader opener and snubber (snubber only with high temperature diaphragm)
- A: $\frac{7}{16}$ " - 20UNF, $\frac{1}{4}$ " SAE male
- U: 6 mm solder. 80 mm length. ODF
- X: $\frac{1}{4}$ " solder. 80 mm length. ODF
- K: 1 m capillary tube with $\frac{1}{4}$ " SAE flare nut and Schrader opener
- L: 1 m capillary tube and $\frac{1}{4}$ " ODM solder connector

Technical Data

Protection According to EN 60529 / IEC 529	IP 00 IP 30 with Terminal Cover IP 65 with PS3-Nxx Cables with Plug or Plug DIN 43650
Inductive load (AC15)	3 A / 230V AC 1.5 A with Microswitch Standard 0.1 A with Gold Plated Contacts
Inductive load (DC)	0.1 A / 230V DC
Motor rating amps (FLA)	6 A / 120/240V AC 2.5 A with Microswitch
Lock rotor amps (LRA)	36 A / 120/240V AC 15 A with Microswitch

For more information see the technical bulletin of PS3

Temperature Range TS Ambient, Storage and Transportation Medium	-40°C ... 70°C -40°C ... 70°C (150°C Range 6)
Pressure Range PS	-0.6 .. 43 bar
Type of Contacts	1 SPDT
Medium Compatibility	HFC, HCFC, HFO/HFO Blends (refrigerant safety group A1)

Pressure Controls Series CS3 for R744/ CO₂ Standard Types With Fixed Settings and Special Types, 60 Pieces Packaging



Features

- Pressure range 8/Q
 - Versions with fixed factory cut-out setting available between 60 bar to 140 bar
 - Maximum Working Pressure of 140 bar
 - Factory Test Pressure of 154 bar
 - Narrow differential (approx. 6 bar) between cut-out and cut-in (in Microswitch version)
- Pressure range 7/P
 - Versions with fixed factory cut-out setting available between 40 bar to 70 bar
 - Maximum Working Pressure of 90 bar
 - Factory Test Pressure of 100 bar
 - Narrow differential (approx. 4 bar) between cut-out and cut-in (in Microswitch version)
- Manual reset versions available
- Precise switching and repeatability; Snap Action Contacts => Chatter Free (Bounce free) and Accurate Operation
- Contacts are designed as SPDT (Single pole double throw) for control function and alarm/status reporting
- Direct compressor mounting with adapter option
- 2 million cycles reliability (TÜV EN 12263 approved)
- IP65 protection if used with PS3-Nxx with plug (acc. EN 175301-803), no additional gasket required (molded into plug)



CS3

Applied Standards

-  per Low Voltage Directive
-  per PED Directive

Selection Table

1. Standard Types

Pressure Range 8/Q

Type	Part No. (Multi-Pack 60 Pcs)	Fixed Setting (bar)		Reset	Electrical Switch	Pressure Connection
		Cut-out	Cut-in			
Pressure Limiter CS3-WQS	0718008M	106 Bar	100 Bar	Automatic	Micro Switch	7/16"-20 UNF Female Thread with Schrader Opener
Pressure Limiter CS3-W8S	0718009M	106 Bar	80 Bar		Standard Switch	
Pressure Cut-out CS3-B8S	0718001M	108 Bar	Approx. 25 Bar below Cut-out	External Manual	Standard Switch	
Safety Pressure Cut-out CS3-S8S	0718002M	108 Bar	Approx. 25 Bar Below Cut-out	Internal Manual	Standard Switch	

Pressure Range 7/P

Type	Part No. (Multi-Pack 60 Pcs)	Fixed Setting (bar)		Reset	Electrical Switch	Pressure Connection
		Cut-out	Cut-in			
Pressure Limiter CS3-WPS	0718007M	54 Bar	50 bar	Automatic	Micro Switch	7/16"-20 UNF Female Thread with Schrader Opener
Pressure Limiter CS3-W7S	0718006M	54 Bar	41 bar		Standard Switch	
Pressure Cut-out CS3-B7S	0718004M	54 Bar	Approx. 13 Bar Below Cut-out	External Manual	Standard Switch	
Safety Pressure Cut-out CS3-S7S	0718005M	54 Bar	Approx. 13 Bar Below Cut-out	Internal Manual	Standard Switch	

Note: Cables with Plug Must Be Ordered Separately (See Page 4).

2. Pressure Controls CS3 Special Type

According to Agreed Specification, 60 Pieces Packaging

Pressure Range 8/Q: Versions with fixed factory cut-out settings available between 60 bar to 140 bar
 Pressure Range 7/P: Versions with fixed factory cut-out settings available between 40 bar to 70 bar

Accessories

Type	Part No.	No of Leads	Diameter of Leads [mm ²]	Temperature Range [°C]	Cable Length [m]
PS3-N15	804 580	3	0.75	-50...+80	1.5
PS3-N30	804 581				3.0
PS3-N60	804 582				6.0

Plug According to EN75301	Part No.
PG9	801 012
PG11	801 013

Technical Data

Protection Class Acc. to EN 60529	IP 65 with PS3-Nxx IP00 without Appliance Socket
Max. Working Pressure PS	Pressure Range 8/Q: 140 Bar Pressure Range 7/P: 90 Bar
Factory Test Pressure PT	Pressure Range 8/Q: 154 Bar Pressure Range 7/P: 100 Bar
Tolerances (As Per EN 12263) - Only for Standard Types (See page 1) Note: Tolerances are Valid Between -20...+55°C.	Pressure Range 8/Q Cut-out Tolerance: 0 to -6 Bar Cut-in Tolerance: +/-3 Bar Pressure Range 7/P Cut-out Tolerance: 0 to -3 Bar Cut-in Tolerance: +/-1.5 Bar

Storage and Transportation Temperature	-40°C...+70°C
Ambient Temperature (Housing)*	-40°C...+70°C
Medium Temperature*	-40°C...+150°C

*) Note: For high temperature applications, i.e. medium temperatures between 70°C and 150°C, the maximum ambient temperature must be derated as per drawing.

E.g.: On medium temperature 120°C the ambient temperature of 55°C around the switch housing should not be exceeded.

T_m = Medium temperature
 T_a = Ambient temperature

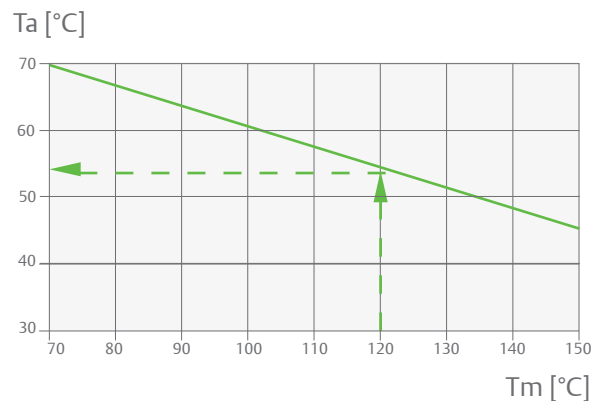

Electrical Data

	Standard (SPDT)	Micro Switch (SPDT)
Inductive Load (AC15)	3A / 230VAC	1.5A / 230VAC
Inductive Load (DC)	0.1A / 230VDC	0.1A / 230VDC
Motor Rating Amps (FLA)	6A / 120 / 240VAC	2.5A / 120 / 240VAC
Lock Rotor Amps (LRA)	36A / 120 / 240VAC	15A / 120 / 240VAC

Pressure Controls Series PS4 with Fixed Settings for OEM Applications; Minimum Order Quantity 100 Pieces

Features

- High- and low pressure switches
- Precise settings and repeatability
- Cable version with IP67 (IP20 for terminal version)
- Normally open/closed electrical contacts (under standard operating conditions)
- TUV approved versions (W & B)
- UL approved



PS4

Standards

- acc. Low Voltage Directive and EN605 (VDE)
- CE0035 acc. Pressure Equipment Directive
- cRUs Underwriter Laboratories file Nr. E258370

Selection Table - Low Pressure Switches With Automatic Reset; Open On Falling Pressure

Type	Part No.	Setting (bar)		Connector (QC) Cable (m)	Test Pressure	EN 12263	Contact Function	Application	Pressure Connection
		Cut-out	Cut-in						
PS4-W1	808269	0.3	1.5	3.0	25 bar	PSL	Open on falling pressure	Low pressure	6mm
PS4-A1	808266	0.4	1.4	1.5		none			7/16-20UNF*
PS4-W1	808208	0.6	1.8	1.5		PSL			6mm
PS4-W3	808235	0.6	1.8	QC					7/16-20UNF*
PS4-W1	808251	0.6	1.8	3.0		6mm			
PS4-W1	808209	0.7	2.1	1.5		PSL			7/16-20UNF*
PS4-W1	808241	0.7	2.4	3.0					6mm
PS4-W3	808284	1.2	1.9	QC		none			7/16-20UNF*
PS4-A1	808247	1.5	2.5	2.5		PSL			6mm
PS4-A1	808229	1.5	3.0	1.5					7/16-20UNF*
PS4-W1	808210	1.7	3.4	1.5		PSL			6mm
PS4-W1	808249	1.7	3.4	1.5					7/16-20UNF*
PS4-W1	808271	1.8	3.2	1.5		None			6mm
PS4-A1	808276	3.3	4.8	1.5					7/16-20UNF*

Note: *) 7/16-20UNF female with Schrader valve opener

Selection Table - High Pressure Switches With Automatic Reset; Open On Rising Pressure

Type	Part No.	Setting (bar)		Connector (QC) Cable (m)	Test Pressure	EN 12263	Contact Function	Application	Pressure Connection
		Cut-out	Cut-in						
PS4-W1	808200	18	13	1.5	41 bar	PSH	open on rising pressure	high pressure	7/16-20UNF*
PS4-W1	808265	18	13	3.0					6mm
PS4-W1	808201	26	20	1.5					7/16-20UNF*
PS4-W1	808224	26	20	3.0					6mm
PS4-W1	808 282	24	18	5.0					7/16-20UNF*
PS4-W3	808236	26	20	QC					1/4"
PS4-A1	808260	26	20	1.5					7/16-20UNF*
PS4-W1	808203	28	21	1.5					1/4"
PS4-A1	808233	28	21	1.5					7/16-20UNF Female with Schrader Opener
PS4-A1	808244	28	21	1.5					
PS4-W3	808273	29	22.8	QC					
PS4-A1	808237	29.5	22.5	1.5					
PS4-A1	808238	31	24	1.5					
PS4-A1	808248	32	24	2.5					
PS4-W1	808205	42	33	1.5					
PS4-W3	808242	42	33	QC					
PS4-W5	808278	45	34	1.5					
PS4-W1	808261	45	35	1.5	6mm				

Selection Table - High Pressure Switches with Automatic Reset; Close on Rising Pressure

Type	Part No.	Setting (Bar)		Connector (QC) Cable (m)	Test Pressure	EN 12263	Contact Function	Application	Pressure Connection
		Cut-Out	Cut-in						
PS4-A2	808212	13	18	1.5	41 bar	PSH	Close on Rising Pressure	fan control	7/16-20UNF Female with Schrader Opener
PS4-W2	808274	14.6	20	1.5					
PS4-A2	808264	17	22.6	1.5					
PS4-W2	808227	22	28	1.5	55 bar	PSH			

Selection Table - High Pressure Switches With Manual Reset; Open on Rising Pressure

Type	Part No.	Setting (Bar)		Connector (QC) Cable (m)	Test Pressure	EN 12263	Contact Function	Application	Pressure Connection
		Cut-Out	Cut-in						
PS4-BL	808202	26	-	1.5	41 bar	PZH	Open on Rising Pressure	high pres- sure EN 378	7/16-20UNF Female with Schrader Opener
PS4-BL	808204	28	-	1.5	55 bar				
PS4-BL	808206	42	-	1.5	69 bar				

Technical Data



Type	PS4-A	PS4-W	PS4-BL
Electrical Data			
Inductive Load 230 VAC	0.1 – 6A		0.1 – 6A
Inductive Load (DC <28V)	2A		2A
Motor rating FLA 230 VAC	6A		6A
Motor rating LRA 230 VAC	36A		36A
Gold plated contacts (option)	25-100mA		25-100mA
Electrical Connection	Cable or Terminal (QC) Version		Cable Version
Life Time	> 100.000 Cycles		
Protection Class IEC 529 / DIN 40050	IP67 (IP20 for Terminal Version)		

Differential Pressure Controls Series FD 113

Features

- Immediate reset (no cooling down period)
- Precise timing
- Adjustable time delay from 30 ... 150 sec (ZU types)
- Separate output signals for operation and alarm
- Suitable for supply voltage 24...240 V AC / DC
- Pressure connection: Flare $\frac{7}{16}$ "-20 UNF, $\frac{1}{4}$ " SAE male

Standards

-  per Low Voltage Directive
-  File No. E85974



FD 113

Type	Part No.	Time Delay		Cut out		Cut in Fixed Setting (bar)	Max. Differential Pressure (bar)	Max. Proof Pressure (bar)
		Adjustable	Factory Setting	Adjusting Range Δp	Factory Setting			
		(sec.)	(sec.)	(bar)	(bar)			
FD 113	0 710 173	-	-	0.3 ... 4.5	0.7	0.2 Above Cut- Out		
FD 113 ZU	3 465 300	30 ... 150	120*					
FD 113 ZU (A22-057) Copeland™ brand products	0 711 195	-	115* Fix	-	0.63 Fix	Appr. 0.9	-0.8 ... 12	25

Note: *) Time Delay tolerance +/- 20%.

Technical Data

Inductive Amp. (AC)	3.0 A / 230 V AC
Inductive Amp. (DC)	0.1 A / 230 V DC
Protection Acc. to EN 60 529	IP 30
Max. Temperature at Pressure Connection	+70°C

Accessories

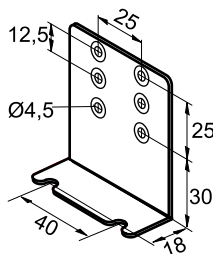

Mounting Bracket Angle
Part No.: 803 799

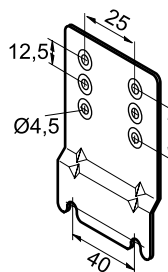

Mounting Plate for Units with Hood
Part No.: 803 801

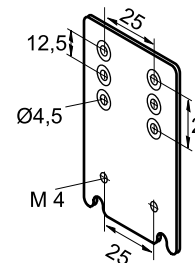

Extension Bracket
Part No.: 803 800



Thermostats

Basic Terms and Technical Information

Characteristics

Alco thermostats are electric circuit control devices which open or close an electric contact depending on temperature changes at the bulb.

Description of Bulb Charges

The application range of thermostats is mainly determined by the charge. Accordingly, various bulb shapes and sizes are necessary.

- **Vapor Charge, Bulb Type A, E, P**
The thermosystem is filled with a medium in vapor phase. A thermostat with vapor charge operates in accordance with temperature changes at the bulb as long as the bulb is the coldest part in the whole system (bellows, capillary tube, bulb). Alco thermostats are equipped with a bellows heater (82 k Ohm, 230 V) to avoid such conditions. On applications with low current the bellows heater has to be removed. Max. bulb temperature is 150°C (70°C for bulb type E). Response time is very fast.
- **Adsorption Charge, Bulb Type F**
This charge only reacts on temperature changes at the bulb. Max. bulb temperature is 100°C. Response time is slow but perfectly suitable for common refrigeration systems.

Adjustment of Switching Points

A thermometer should always be used for comparison when adjusting the switching points on temperature controls. The setting scale on the device is intended to serve for orientation, showing the setting range of the upper switching point t_{\max} in °C and °F and the value of the temperature differential Δt in K as difference between the upper switching point t_{\max} and the lower switching point t_{\min} . The upper switching point t_{\max} has to be adjusted on the scale, whereas the lower switching point t_{\min} is given by adjustment of the desired switching differential Δt . The formula is:

$$\text{Upper switching point} - \text{Differential} = \text{Lower switching point}$$

$$t_{\max} - \Delta t = t_{\min}$$

Important!

The differential Δt mentioned on the differential scale and in the technical data refers to the upper part of the setting range and the upper switching point.

In the lower part of the setting range an increase of the differential Δt can be expected. The lowest possible lower switching point t_{\min} is mentioned in the selection tables and is helpful to select switching points with large differentials Δt in the lower temperature range.

Bulb Sizes

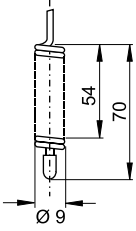
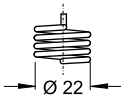
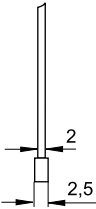
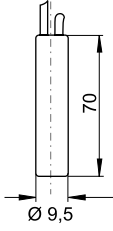
A	E	P	F
			
Vapor 2m, Capillary with Bulb	Vapor Coil, 0m	Vapor 2m, Capillary with Function C and D 6m	Adsorption 2m, Capillary with Bulb

Function of Contacts

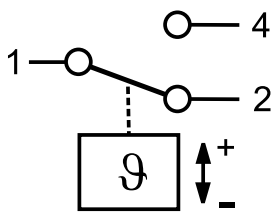

SPDT

- On temperature rise above setting 1-2 opens and 1-4 closes.
- On temperature drop below setting 1-2 closes and 1-4 opens.

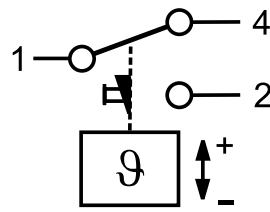

SPDT with manual reset min.

- On temperature drop below setting 1-2 closes. 1-4 opens and latches.
- The device can be manually reset when the temperature has risen at least 2K above setting.

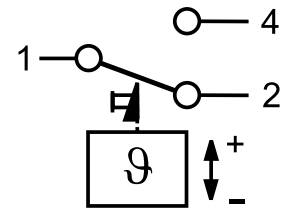

SPDT with manual reset max.

- On temperature rise above setting 1-2 opens and 1-4 closes and latches.
- The device can be manually reset when the temperature has dropped 2K below setting.

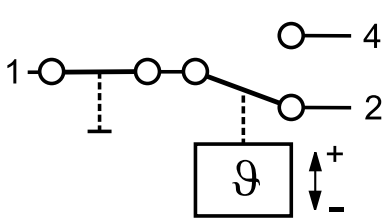

SPDT with off switch AUTOmatic - STOP

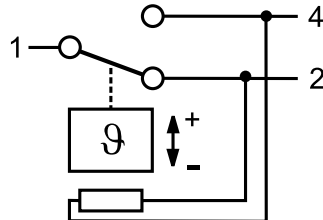

SPDT with bellows heater includes a 82 k Ohm, 230 V AC/DC resistor

Standards and Regulations

Important for the installation of thermostats:

EN 60730-2-9 Specification for temperature controls and temperature cut-outs.

EN 60947-1/ Specifications for low-voltage
EN 60947-5-1 switchgear.

Thermostats Series TS1

Features

- Adjustable temperatures and differentials
- Chatter resistant contacts (bounce-free)
- High operational current, locked rotor max. 144 A (LRA)
- Standard SPDT with same operational current rating for both contacts
- Captive terminal and cover screws
- Range and differential individually lockable by wire seal

Technical Data

Type of Contacts	1 SPDT
Heating load (AC1)	24A / 230V AC
Inductive load (AC15)	10A / 230V AC
Inductive load (DC13)	0.1A / 230V DC
Motor rating (FLA):	24 A / 120/240V AC
Locked rotor (LRA):	144 A / 120/240V AC
Ambient Temperature Range	-50°C to +70°C
Cable Entry	Grommet PG 16
Protection Acc. to EN 60529 / IEC 529	IP 44 (IP 30 with Selector Switch)
Bellows Heater at Vapor Charge	82 K Ohm. 230 V AC / DC (12 and 24 V DC Upon Request)



TS1 Top Operated

TS1 Flush Mounted

TS1 Front Operated

Standards

- per Low Voltage Directive
- US LISTED Underwriter Laboratories File Nr: E85974

Type	Part No.	Adjustment Range		Lowest Setpoint	Factory Setting	Max. Bulb Temp.	Temperature Sensor	
		Upper Setpoint	Differential Setpoint ΔT				Charge	Cap. Tube Length
		(°C)	(K)					
Thermostats Top Operated								
Thermostats Without Off-Switch								
TS1-A2P	4 530 400	-30 ... +15	1.5 ... 16	-36	-1 / -6	+150	Vapor	2m Capillary
TS1-A3P	4 356 700	-10 ... +35	1.5 ... 16	-23	+3 / -2			
TS1-A1A	4 351 500	-45 ... -10	1.5 ... 16	-55	-18 / -20	+150	Vapor	2m Capillary and Bulb
TS1-A2A	4 351 600	-30 ... +15	1.5 ... 16	-36	-1 / -6			
TS1-A3A	4 352 500	-10 ... +35	1.5 ... 16	-23	+3 / -2			
TS1-A4F Defrost- and Universal Thermostat	4 351 800	-30 ... +35	2.8 ... 20	-35	+5 / 0	+100	Adsorption	2m Capillary and Bulb
TS1-A5F	4 458 400	+20 ... +60	3 ... 10	+10	+35 / +30			
Thermostats With Off-Switch								
TS1-B2A	4 366 800	-30 ... +15	1.5 ... 16	-36	-1 / -6	+100	Adsorption	
TS1-B3A	4 366 900	-10 ... +35	1.5 ... 16	-23	+3 / -2			
TS1-B4F	4 367 000	-30 ... +35	2.8 ... 20	-35	+5 / 0			
Frost Monitors Top Operated								
Frost Monitors Without Off-Switch								
TS1-C0P	4 352 100	+4.5 ... +20	2.5 fix	+2	4,5 / +2	+150	Vapor	6m Capillary
TS1-D0P Low Temp. Cut Out	4 352 200	+4.5 ... +20	Man. Reset ca. 2.5 fix	+2	+2			

Type	Part No.	Adjustment Range		Lowest Setpoint (°C)	Factory Setting (°C)	Max. Bulb Temp. (°C)	Temperature Sensor	
		Upper Setpoint (°C)	Differential Setpoint ΔT (K)				Charge	Cap. Tube Length
Room Thermostats Top Operated Room Thermostats Without Off-Switch, Including Insulation Console								
TS1-A3E	4 355 300	-10 ... +35	1.5 ... 16	-23	+20 / +18	+70	Vapor	0m coil
Room Thermostats With Off-Switch, Including Insulation Console								
TS1-B3E	4 344 500	-10 ... +35	1.5 ... 16	-23	+20 / +18	+70	Vapor	0m coil
Thermostats Front Operated Thermostats Without Off-Switch								
TS1-E1A	4 361 000	-45 ... -10	2 ... 16	-55	-18 / -20	+150	Vapor	2m capillary and bulb
TS1-E2A	4 356 200	-30 ... +10	1.5 ... 15	-36	+4 / +2			
TS1-E3A	4 365 200	-10 ... +25	1.5 ... 15	-23	+3 / -2			
TS1-E4F Defrost- and uni- versal thermostat	4 367 500	-25 ... +30	2.8 ... 20	-30	+5 / 0	+100	Adsorption	
TS1-E5F	4 338 100	+20 ... +60	3 ... 10	+10	+35 / +30			
Thermostats With Off-Switch								
TS1-F1A	4 367 100	-45 ... -10	2 ... 16	-55	-18 / -20	+150	Vapor	2m capillary and bulb
TS1-F2A	4 367 200	-30 ... +10	1.5 ... 15	-36	-1 / -6			
TS1-F3A	4 367 400	-10 ... +25	1.5 ... 15	-23	+3 / -2			
Room Thermostats Front Operated Room Thermostats Without Off-Switch, Including Insulation Console								
TS1-E1E	4 365 300	-45 ... -10	2 ... 16	-55	-18 / -20	+70	Vapor	0m coil
TS1-E2E	4 356 800	-30 ... +10	1.5 ... 15	-36	+4 / +2			
Room Thermostats with Off-Switch, Including Insulation Console								
TS1-F1E	4 368 000	-45 ... -10	2 ... 16	-55	-18 / -20	+70	Vapor	0m coil
TS1-F2E	4 368 100	-30 ... +10	1.5 ... 15	-36	+4 / +2			
TS1-F3E	4 368 200	-10 ... +25	1.5 ... 15	-23	+20 / +18			
Thermostats for Flush Mounting Thermostats for Flush Mounting Without Off-Switch								
TS1-G2A	4 355 400	-30 ... +15	1.5 ... 15	-36	+4 / +2	+150	Vapor	2m capillary and bulb
TS1-G4F Defrost- and uni- versal thermostat	4 355 600	-30 ... +35	2.8 ... 20	-35	+5 / 0	+100	Adsorption	
Thermostats for Flush Mounting With Off-Switch								
TS1-H2A	4 355 500	-30 ... +15	1.5 ... 15	-36	-1 / -6	+150	Vapor	2m capillary and bulb
TS1-H3A	4 367 900	-10 ... +35	1.5 ... 15	-23	+3 / +2			

Accessories

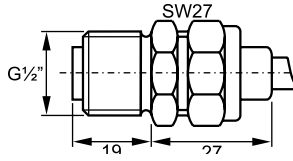

Capillary Tube Gland. Brass
for Bulb Style A / C
Part No.: 803 807

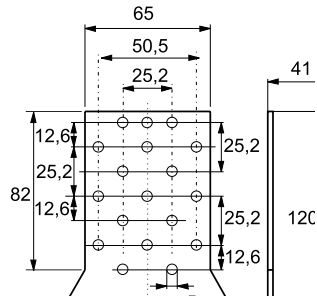

Universal Mounting Bracket
Part No.: 803 798

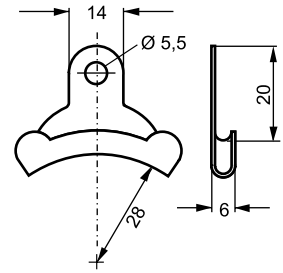

Capillary Tube Holder
for Frost Monitors Standard
Part No.: 803 778

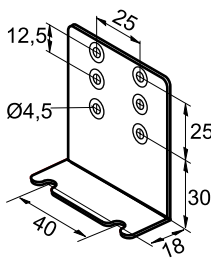

Mounting Bracket Angle
Part No.: 803 799

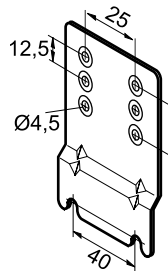

Mounting Plate
for Units with Hood
Part No.: 803 801

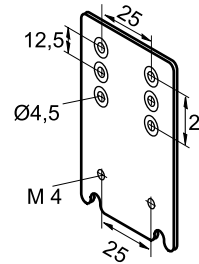

Extension Bracket
Part No.: 803 800

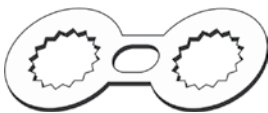

Locking Plate
Part No.: 803783 (20 pcs)







System Protectors and Moisture Indicators

Filter Driers

Basic Terminology and Technical Information

Function

The purpose of filter driers is to keep the refrigeration circuit clean of water, acid and solid contaminants. In case of contamination, corrosion and ice building can occur, as well as malfunction of the compressor.

Property of Desiccants

Molecular Sieves

This kind of desiccant has a very good drying effect independent of the oil content of the refrigerant. Molecular sieve is a fast acting desiccant and will remove moisture even when the water content of the refrigerant is low and when the temperature of the liquid refrigerant is high.

Activated Alumina

Activated alumina incorporate an excellent acid capacity. By selecting a specific mixture of both desiccants, an optimum effect can be achieved to cover the requirements of all kinds of applications. Liquid filter driers are specially designed for a high water capacity, whereas suction line filter driers feature a high acid and filtration capacity.

Flow Capacity

Flow capacity refers to ARI-Standard 710-86 and DIN 8949 and is based on a pressure drop of 0.07 bar, +30°C liquid temperature and -15°C evaporating temperature for common refrigerants.

The flow capacities are given at two levels of pressure drop: 0.07 and 0.14 bar.

For Filter drier selection under other operating conditions, use the correction factors given in tables at the end of liquid line filter driers BFK, ADK, FDB, ADKS, FDH, FDS

Water Capacity

The water capacity for R22 refers to ARI 710-86 and DIN8948 is based on a liquid temperature of 24/52°C and an equilibrium point dryness (EPD) of 60 PPM water in refrigerant. The EPD for other refrigerants according to DIN 8949 is as follows:

Refrigerant	EPD (PPM)
R134a	50
R407C	50
R404A	50
R507	50
R410A	50



Selection Guide for Filter and Filter Driers

Selection Criteria	Series										
	BFK	ADK	FDB	ADKS/FDH with Core		FDS-24 with Core		ASF	ASD	BTAS with Core	
				H/S/W48	F48	S24	F24			AF	AF-D
Hermetic Design	+	+	+					+	+		
For Exchangeable Cores				+	+	+	+			+	+
Quick Cap Fange						+	+				
Filter					+		+	+		+	
Filter Drier	+	+	+	+		+			+		+
For Liquid Service	+	+	+	+		+					
For Suction Service					+	+	+	+	+	+	+
For Heat Pumps (Bi-Flow)	+										
Shell Material	Steel	Steel	Steel	Steel		Steel		Steel	Steel	Brass	
Max. Allowable Pressure PS	45 Bar	45 Bar	45 Bar	34.5*/46.0* Bar		34.5* Bar		27.5 Bar		24 Bar	

*Dependent on Medium Temperature

Bi-flow Filter Driers Series BFK

Hermetic Design for Liquid Refrigerants

Features

- Solid block style
- Integrated check valves ensure Bi-flow capability, eliminate the need for external check valves and reduce the external piping
- ODF Copper fittings for easy brazing
- Pattern flow for non-turbulent performance
- High water, acid adsorption capacity
- Filtration down to 40 microns
- Temperature range TS: -45°C...+65°C
- Max. allowable working pressure PS: 45 bar
- CE marking not required acc. PED
-  Underwriter Laboratories



BFK

Selection Table

Type	Part No.	Connection Size & Type	Nominal Flow Capacity (kW)									
			At 0.07 bar Pressure Drop					At 0.14 Bar Pressure Drop				
			R134a	R22	R407C	R404A R507	R410A	R134a	R22	R407C	R404A R507	R410A
BFK-052	007 343	1/4"(6mm)SAE	5.2	5.7	5.4	3.7	5.6	8.0	8.8	8.4	5.7	8.7
BFK-052S	007 344	1/4"ODF	6.8	7.3	7.0	4.8	7.2	10.1	11.1	10.6	7.2	10.9
BFK-083	007 345	3/8"(10mm)SAE	10.6	11.5	11.0	7.5	11.4	16.9	18.4	17.6	12.0	18.2
BFK-083S	007 346	3/8"ODF	12.0	13.1	12.5	8.5	12.9	20.6	22.5	21.5	14.7	22.2
BFK-084	007 347	1/2"(12mm)SAE	15.2	16.6	15.8	10.8	16.4	25.8	28.1	26.8	18.3	27.8
BFK-084S	007 348	1/2"ODF	15.6	17.0	16.2	11.1	16.8	28.7	31.3	29.9	20.4	30.9
BFK-163	007 349	3/8"(10mm)SAE	13.6	14.9	14.2	9.7	14.7	21.0	22.9	21.8	14.9	22.6
BFK-163S	007 350	3/8"ODF	15.5	16.9	16.1	11.0	16.7	23.8	26.0	24.8	17.0	25.7
BFK-164	007 351	1/2"(12mm)SAE	20.3	22.1	21.1	14.4	21.9	27.5	30.0	28.6	19.6	29.6
BFK-164S	007 352	1/2"ODF	24.3	26.5	25.3	17.3	26.1	34.4	37.6	35.9	24.5	37.1
BFK-165	007 353	5/8"(16mm)SAE	25.1	27.4	26.2	17.9	27.1	35.3	38.5	36.8	25.1	38.0
BFK-165S	007 354	5/8"ODF	25.6	28.0	26.7	18.3	27.6	37.0	40.4	38.5	26.3	39.9
BFK-305S	007 356	5/8"(16mm) ODF	34.1	37.3	35.6	24.3	36.8	52.8	57.7	55.0	37.6	56.9
BFK-307S	007 357	7/8"(22mm) ODF	40.6	44.3	42.3	28.9	43.7	65.7	71.7	68.4	46.8	70.8
BFK-309S	007 358	1 1/8"ODF	47.0	51.3	49.0	33.5	50.7	79.9	87.2	83.2	56.9	86.1

Note: The rated flow capacities are in accordance with ARI standard 710-86 and DIN 8949 at +30°C liquid temperature and -15°C evaporating temperature.

For selection of other operating condition, please use Controls Navigator selection program.

Water and Acid Adsorption Capacity

Type	Water Adsorption Capacity (gram)										Acid Adsorption Capacity (g)
	Liquid Temperature 24 °C					Liquid Temperature 52 °C					
	R134a	R22	R404A/R507	R407C	R410A	R134a	R22	R404A/R507	R407C	R410A	
BFK-05...	4.4	4.1	4.5	3.4	2.8	4.1	3.8	4.3	2.8	2.2	0.3
BFK-08...	9.6	9.0	9.9	7.5	6.2	8.9	8.2	9.4	6.0	4.7	0.6
BFK-16...	18.9	17.7	19.5	14.8	12.2	17.5	16.2	18.5	11.9	9.3	1.2
BFK-30...	34.5	32.3	35.6	27.1	22.4	31.9	29.6	33.7	21.7	17.0	2.0

Filter Driers Series ADK

Hermetic Design for Liquid Refrigerants

Features

- Robust block with optimum blend of molecular sieve and activated alumina
- ODF Copper fittings for easy brazing
- High water and acid adsorption capacity
- Filtration down to 20 microns
- Temperature range TS: -45°C...+65°C
- Max. allowable working pressure PS: 45 bar
- CE marking not required acc. PED
-  Underwriter Laboratories



ADK

Selection Table

Type	Part No.	Nominal Flow Capacity (kW)											
		At 0.07 bar Pressure Drop											
		R22	R134a	R404A R507	R407C	R407F	R410A	R744	R448A	R449A	R450A	R513A	R1234ze
ADK-032	003 595	7.3	6.7	4.8	7.0	7.0	7.2	10.6	6.1	5.9	5.9	6.4	6.2
ADK-032S	003 596	8.8	8.1	5.7	8.4	8.5	8.7	12.8	7.4	7.0	7.1	7.7	7.5
ADK-036MMS	003 597	8.0	7.3	5.2	7.6		7.9	11.6	6.7	6.4	6.4	7.0	6.8
ADK-052	003 598	7.6	6.9	4.9	7.2	7.3	7.5	11.0	6.4	6.1	6.1	6.6	6.5
ADK-052S	003 599	10.8	9.9	7.0	10.3	10.4	10.7	15.7	9.1	8.6	8.7	9.4	9.2
ADK-056MMS	003 600	10.0	9.2	6.5	9.5		9.9	14.5	8.4	8.0	8.0	8.7	8.5
ADK-053	003 601	14.2	13.0	9.2	13.5	13.6	14.0	20.6	11.9	11.3	11.4	12.3	12.1
ADK-053S	003 602	16.4	15.0	10.7	15.6	15.8	16.1	23.8	13.7	13.1	13.1	14.3	14.0
ADK-0510MMS	003 603	16.4	15.0	10.7	15.6		16.1	23.8	13.7	13.1	13.1	14.3	14.0
ADK-082	003 604	7.8	7.1	5.1	7.4	7.5	7.7	11.3	6.5	6.2	6.2	6.8	6.7
ADK-082S	003 605	11.9	10.9	7.8	11.4	11.5	11.8	17.4	10.0	9.6	9.6	10.4	10.2
ADK-086MMS	003 606	10.7	9.8	7.0	10.2		10.5	15.5	9.0	8.5	8.6	9.3	9.1
ADK-083	003 607	16.4	15.0	10.7	15.6	16.0	16.2	23.8	13.8	13.1	13.2	14.3	14.0
ADK-083S	003 608	16.4	15.0	10.7	15.7	15.8	16.2	23.9	13.8	13.1	13.2	14.3	14.0
ADK-0810MMS	003 609	16.4	15.0	10.7	15.6		16.2	23.8	13.8	13.1	13.2	14.3	14.0
ADK-084	003 610	25.7	23.5	16.7	24.5	24.7	25.3	37.3	21.5	20.5	20.6	22.4	21.9
ADK-084S	003 611	26.8	24.5	17.5	25.6	25.8	26.4	39.0	22.5	21.4	21.5	23.3	22.9
ADK-0812MMS	003 612	26.3	24.1	17.2	25.1		26.0	38.3	22.1	21.1	21.1	22.9	22.5
ADK-162	003 613	8.0	7.3	5.2	7.6	7.7	7.8	11.6	6.7	6.4	6.4	6.9	6.8
ADK-163	003 614	16.8	15.4	10.9	16.0	16.2	16.5	24.4	14.1	13.4	13.4	14.6	14.3
ADK-163S	003 615	18.7	17.2	12.2	17.9	18.1	18.5	27.2	15.7	15.0	15.0	16.3	16.0
ADK-1610MMS	003 616	18.7	17.1	12.2	17.8		18.5	27.2	15.7	15.0	15.0	16.3	16.0
ADK-164	003 617	31.3	28.7	20.4	29.9	34.1	30.9	45.5	26.3	25.1	25.1	27.3	26.7
ADK-164S	003 618	36.0	33.0	23.5	34.3	35.1	35.5	52.3	30.2	28.8	28.9	31.4	30.7
ADK-1612MMS	003 619	32.3	29.6	21.1	30.8		31.9	47.0	27.1	25.9	25.9	28.2	27.6
ADK-165	003 620	44.8	41.1	29.2	42.8	43.2	44.3	65.2	37.7	35.9	36.0	39.1	38.3
ADK-165S	003 621	49.7	45.6	32.4	47.4	47.9	49.1	72.3	41.8	39.8	39.9	43.3	42.5
ADK-303	003 622	17.7	16.2	11.5	16.9	17.1	17.5	25.7	14.9	14.2	14.2	15.4	15.1
ADK-304	003 623	31.3	28.7	20.4	29.9	30.2	30.9	45.5	26.3	25.1	25.1	27.3	26.7
ADK-304S	003 624	36.0	33.0	23.5	34.4	34.7	35.6	52.4	30.3	28.8	28.9	31.4	30.8
ADK-305	003 626	52.6	48.2	34.3	50.2	50.7	52.0	76.6	44.2	42.1	42.2	45.9	45.0
ADK-305S	003 627	52.8	48.4	34.4	50.4	46.4	52.1	76.8	44.3	42.2	42.4	46.0	45.1
ADK-307S	003 628	66.3	60.7	43.2	63.2	63.9	65.4	96.4	55.7	53.0	53.2	57.8	56.6
ADK-414	003 629	36.8	33.7	24.0	35.1		36.3	53.5	30.9	29.4	29.5	32.1	31.4
ADK-415	003 632	58.6	53.7	38.2	55.9		57.8	85.2	49.2	46.9	47.0	51.1	50.0
ADK-415S	003 633	63.0	57.7	41.1	60.1		62.2	91.6	52.9	50.4	50.5	54.9	53.8
ADK-417S	003 634	77.9	71.4	50.8	74.3	80.0	76.9	113.3	65.4	62.4	62.5	67.9	66.6
ADK-757S	003 635	105.5	96.7	68.8	100.7	122.8	104.2	153.5	88.6	84.4	84.7	92.0	90.1
ADK-759S	003 636	117.2	107.4	76.4	111.8	133.9	115.7	170.4	98.4	93.8	94.0	102.1	100.1

Water and Acid Capacity

Size	Water Adsorption Capacity (gram)										Acid Adsorption Capacity (gram)
	Liquid Temperature 24 °C					Liquid Temperature 52 °C					
	R134a	R22	R404A/ R507	R407C	R410A	R134a	R22	R404A/ R507	R407C	R410A	
ADK-03	4.9	4.5	4.9	3.4	2.8	4.4	4.0	4.6	2.9	2.4	0.8
ADK-05	11.8	10.8	11.8	8.2	6.8	10.6	9.6	10.9	7.0	5.8	2.3
ADK-08	17.9	16.4	18.0	12.4	10.3	16.2	14.6	16.6	10.7	8.8	3.3
ADK-16	23.0	21.0	23.1	16.0	13.2	20.8	18.8	21.3	13.8	11.4	4.5
ADK-30	51.8	48.6	53.5	36.9	30.6	47.4	43.3	49.3	31.8	26.3	11.3
ADK-41	81.7	76.6	84.3	58.2	48.3	74.8	68.3	77.8	50.2	41.4	16.8
ADK-75	143.5	134.5	148.1	102.1	84.8	131.4	120.0	136.6	88.1	72.8	29.9

Note: The Water Capacities are According to ARI-Standard 710 for R22 and are Based on a Equilibrium Point Dryness (EPD) of 60 PPM Water in Refrigerant. The EPD for All Other Mentioned Refrigerants According to DIN 8949 is 50 PPM.

Connections

Type	Part No.	Connection			
		Solder/ODF		Flare/SAE	
		mm	inch	mm	inch
ADK-032	003 595			6	1/4
ADK-036MMS	003 597	6			
ADK-032S	003 596		1/4		
ADK-052	003 598			6	1/4
ADK-056MMS	003 600	6			
ADK-052S	003 599		1/4		
ADK-053	003 601			10	3/8
ADK-0510MMS	003 603	10			
ADK-053S	003 602		3/8		
ADK-082	003 604			6	1/4
ADK-086MMS	003 606	6			
ADK-082S	003 605		1/4		
ADK-083	003 607			10	3/8
ADK-0810MMS	003 609	10			
ADK-083S	003 608		3/8		
ADK-084	003 610			12	1/2
ADK-0812MMS	003 612	12			
ADK-084S	003 611		1/2		
ADK-162	003 613			6	1/4
ADK-163	003 614			10	3/8
ADK-1610MMS	003 616	10			
ADK-163S	003 615		3/8		
ADK-164	003 617			12	1/2
ADK-1612MMS	003 619	12			
ADK-164S	003 618		1/2		
ADK-165	003 620			16	5/8
ADK-165S	003 621		5/8		
ADK-303	003 622			10	3/8
ADK-304	003 623			12	1/2
ADK-304S	003 624		1/2		
ADK-305	003 626			16	5/8
ADK-305S	003 627		5/8		
ADK-307S	003 628	22	7/8		
ADK-414	003 629			12	1/2
ADK-415	003 632			16	5/8
ADK-415S	003 633		5/8		
ADK-417S	003 634	22	7/8		
ADK-757S	003 635	22	7/8		
ADK-759S	003 636		1-1/8		

Nominal Operating Capacities Based on Following Conditions:

Refrigerant	Evaporating Temperature	Liquid Temperature
R744	-40°C	-10°C
R22, R134a, R404A, R407C, R407F R410A, R450A, R507, R513A, R1234ze, R448A, R449A	-15°C	+30°C

For selection of other operating condition, please use Controls Navigator selection program.

Filter Driers Series FDB Hermetic Design, Bead Style for Liquid Refrigerants

Features

- Compacted bead style (spring loaded)
- Optimum blend of molecular sieve and activated alumina combined with high filtration capacity
- Filtration first for more effective use of surface area of desiccant
- High water and acid capacity
- Cushioned flow for non-turbulent performance
- ODF Copper fittings for easy brazing
- Rugged steel shells
- Corrosion-resistant epoxy paint
- Temperature range TS: -40°C...+65°C
- Max. allowable working pressure PS: 45 bar
- CE marking not required acc. PED
-  Underwriter Laboratories



FDB

Selection Table

Type	Part No.	Nominal Flow Capacity (kW)											
		At 0.07 bar Pressure Drop											
		R134a	R22	R407C	R404A/ R507	R407A	R407F	R410A	R448A	R449A	R450A	R513A	R1234ze
FDB-032	059 305	6.3	6.9	6.6	4.5	6	6.7	6.8	6.0	5.9	5.8	5.5	5.5
FDB-032S	059 306	9.7	10.6	10.1	6.9	9.2	10.2	10.5	9.2	9.1	8.9	8.5	8.5
FDB-052	059 307	6.5	7.1	6.8	4.6	6.1	6.8	7.0	6.2	6.1	6.0	5.7	5.7
FDB-052S	059 309	9.7	10.6	10.1	6.9	9.2	10.2	10.5	9.2	9.1	8.9	8.5	8.5
FDB-053	059 308	15.5	16.9	16.1	11.0	14.6	16.3	16.7	14.7	14.4	14.2	13.5	13.6
FDB-053S	059 310	19.3	21.1	20.1	13.8	18.3	20.3	20.8	18.4	18.0	17.7	16.9	16.9
FDB-082	059 311	6.8	7.4	7.1	4.8	6.4	7.1	7.3	6.4	6.3	6.2	5.9	5.9
FDB-082S	059 314	9.9	10.8	10.3	7.0	9.4	10.4	10.7	9.4	9.2	9.1	8.6	8.7
FDB-083	059 312	15.8	17.2	16.4	11.2	14.9	16.6	17.0	15.0	14.7	14.4	13.8	13.8
FDB-083S	059 315	19.8	21.6	20.6	14.1	18.7	20.8	21.3	18.8	18.4	18.1	17.3	17.3
FDB-084	059 313	26.4	28.8	27.5	18.8	24.9	27.8	28.4	25.1	24.6	24.2	23.0	23.1
FDB-084S	059 316	28.3	30.9	29.5	20.1	26.8	29.8	30.5	26.9	26.4	25.9	24.7	24.8
FDB-162	059 317	6.8	7.4	7.1	4.8	6.4	7.1	7.3	6.4	6.3	6.2	5.9	5.9
FDB-163	059 318	16.2	17.7	16.9	11.5	15.3	17.1	17.5	15.4	15.1	14.9	14.2	14.2
FDB-163S	059 321	23.0	25.1	23.9	16.4	21.7	24.2	24.8	21.9	21.4	21.1	20.1	20.1
FDB-164	059 319	27.9	30.5	29.1	19.9	26.4	29.4	30.1	26.6	26.0	25.6	24.4	24.5
FDB-164S	059 322	36.0	39.3	37.5	25.6	34	37.9	38.8	34.2	33.6	33.0	31.4	31.5
FDB-165	059 320	36.6	40.0	38.2	26.1	34.6	38.6	39.5	34.9	34.2	33.6	32.0	32.1
FDB-165S	059 323	48.8	53.3	50.8	34.8	46.2	51.4	52.6	46.4	45.5	44.7	42.6	42.8
FDB-303	059 324	18.0	19.7	18.8	12.8	17.1	19	19.4	17.2	16.8	16.5	15.8	15.8
FDB-304	059 325	31.8	34.7	33.1	22.6	30.1	33.5	34.2	30.2	29.6	29.1	27.8	27.8
FDB-304S	003 667	38.0	41.5	39.6	27.1	35.9	40	41.0	36.2	35.4	34.8	33.2	33.3
FDB-305	059 326	40.3	44.0	42.0	28.7	38.1	42.4	43.4	38.3	37.6	36.9	35.2	35.3
FDB-305S	059 327	53.8	58.7	56.0	38.3	50.8	56.6	57.9	51.2	50.1	49.3	47.0	47.1
FDB-307S	059 328	60.5	66.1	63.1	43.1	57.2	63.7	65.2	47.3	46.4	45.6	43.4	43.6
FDB-415	059 329	49.7	54.3	51.8	35.4	47	52.4	53.6	57.6	56.5	55.5	52.9	53.0
FDB-417S	059 330	77.2	84.3	80.4	55.0	73	81.3	83.2	73.5	72.0	70.8	67.5	67.6

Water Adsorption Capacity

Type	Unit Size	Water Adsorption Capacity (Net) in grams							
		25 °C Liquid Refrigerant				52 °C Liquid Refrigerant			
		R134a	R22	R407C	R404A/ R507	R134a	R22	R407C	R404A/ R507
FDB-03...	3	1.9	2.0	1.7	1.9	1.8	1.7	1.6	1.9
FDB-05...	5	5.5	5.8	5.0	5.5	5.2	4.9	4.5	5.3
FDB-08...	8	8.8	9.3	8.0	8.8	8.4	7.9	7.2	8.5
FDB-16...	16	17.7	18.5	15.9	17.6	16.8	15.7	14.5	17.1
FDB-30...	30	31.7	33.0	28.5	31.6	30.1	28.2	26.0	30.5
FDB-41...	41	44.2	46.2	39.9	44.1	42.1	39.4	36.3	42.7

Note: The water capacities are according to ARI-Standard 710 for R22 and are based on an equilibrium point dryness (EPD) of 60 PPM water in refrigerant. The EPD for all other mentioned refrigerants according to DIN 8949 is 50 PPM.

Connections

Type	Part No.	Connection	
		Solder/ODF or Flare/SAE	
		Inch	mm
FDB-032	059 305	1/4"SAE	6mm SAE
FDB-032S	059 306	1/4"ODF	
FDB-052	059 307	1/4"SAE	6mm SAE
FDB-052S	059 309	1/4"ODF	
FDB-053	059 308	3/8"SAE	10mm SAE
FDB-053S	059 310	3/8"ODF	
FDB-082	059 311	1/4"SAE	6mm SAE
FDB-082S	059 314	1/4"ODF	
FDB-083	059 312	3/8"SAE	10mm SAE
FDB-083S	059 315	3/8"ODF	
FDB-084	059 313	1/2"SAE	12mm SAE
FDB-084S	059 316	1/2"ODF	
FDB-162	059 317	1/4"SAE	6mm SAE
FDB-163	059 318	3/8"SAE	10mm SAE
FDB-163S	059 321	3/8"ODF	
FDB-164	059 319	1/2"SAE	12mm SAE
FDB-164S	059 322	1/2"ODF	
FDB-165	059 320	5/8"SAE	16mm SAE
FDB-165S	059 323	5/8"ODF	
FDB-303	059 324	3/8"SAE	10mm SAE
FDB-304	059 325	1/2"SAE	12mm SAE
FDB-304S	003 667	1/2"ODF	
FDB-305	059 326	5/8"SAE	
FDB-305S	059 327	5/8"ODF	16mm SAE
FDB-307S	059 328	7/8"ODF	
FDB-415	059 329	5/8"SAE	16mm SAE
FDB-417S	059 330	7/8"ODF	

Nominal Operating Capacities Based on Following Conditions:

Refrigerant	Evaporating Temperature	Liquid Temperature
R22, R134a, R404A, R407C, R410A, R450A, R507, R513A, R1234ze, R448A, R449A	-15°C	+30°C

For selection of other operating condition, please use Controls Navigator selection program.

Filter Drier Shells Series ADKS-Plus for Liquid - and Suction Applications With Replaceable Cores

Features

- Rustproof Aluminum flange cover with notch hole for ease of mounting
- ODF Copper fittings for easy brazing
- Rigid core holder from steel (no plastic)
- Service-friendly core holder and flange cover
- Optimum flow capacity at low pressure drop
- Temperature range TS: -45°C...+65°C
- Max. allowable working pressure PS:
34.5 bar (-10°C...+65°C)
25.9 bar (-45°C...-10°C)
- CE marking according PED
-  Underwriter Laboratories



ADKS-Plus

Selection Table

Type	Part No.	Connection Solder/ODF		Nominal Flow Capacity (kW)												Number of Blocks S48, H48 W48, F48
				Pressure Drop 0.07 bar												
		(mm)	(inch)	R22	R134a	R404A/R507	R407A	R407F	R407C	R410A	R448A	R449A	R450A	R513A	R1234ze	
Conformity Assessment Cat. I, Procedure Module A																
485T	883 551	16	5/8	78	72	51	68	75	75	77	68	67	66	63	63	1
487T	883 552	22	7/8	145	133	95	126	140	138	143	126	124	122	116	116	
489T	883 553		1 1/8	204	187	133	177	197	195	202	178	174	172	163	164	
4811T	883 554	35	1 3/8	285	261	186	247	275	272	281	248	243	239	228	228	
4813T MM	883 836	42		310	284	202	268	299	196	306	270	265	260	248	249	
4817	882 603	54	2 1/8	Primary for Suction Line Applications												
967T	883 555	22	7/8	159	146	104	138	153	152	157	139	136	134	127	128	2
969T	883 556		1 1/8	250	229	163	217	241	239	247	218	214	210	200	201	
9611T	883 557	35	1 3/8	305	279	199	264	294	291	301	266	260	256	244	245	
9613T	883 558		1 5/8	350	321	228	303	337	334	345	305	299	294	280	281	
9613T MM	883 559	42		355	325	231	307	342	339	350	309	303	298	284	285	
9617	887 215	54		350	321	228			334	345	305	299	294	280	281	
1449T	883 560		1 1/8	252	231	165	219	243	241	249	220	216	212	202	202	3
14411T	883 561	35	1 3/8	351	322	229	304	339	335	347	306	300	295	281	282	
14413T	883 562		1 5/8	354	325	231	307	342	338	350	309	303	298	284	284	
14413T MM	883 563	42		360	330	235	312	347	343	355	314	307	302	288	289	
14417T	883 564	54	2 1/8	420	385	274	364	405	401	415	366	359	353	336	337	
Conformity Assessment Cat. II, Procedure Module D1																
19211T	883 565	35	1 3/8	358	328	233	310	345	342	353	312	306	301	287	287	4
19213T	883 566		1 5/8	395	362	258	342	381	377	390	344	337	332	316	317	
19213T MM	883 567	42		400	366	261	346	386	382	395	349	342	336	320	321	
19217T	883 568	54	2 1/8	430	394	281	373	415	411	425	375	368	361	344	345	

Nominal Capacity (Q_n) is Based on the Following Conditions:

Refrigerant	Evaporating Temperature	Liquid Temperature
R744	-40°C	-10°C
R22, R134a, R404A, R407C, R410A, R450A, R507, R513A, R1234ze R448A, R449A	-15°C	+30°C

Filter Drier Shells Series FDH for Liquid- and Suction Applications With Replaceable Cores

Features

- Steel flange cover with notch hole for ease of mounting
- Plated steel ODF connections
- Rigid core holder from steel (no plastic)
- Service-friendly core holder and flange cover
- Optimum flow capacity at low pressure drop
- Temperature range TS: -45°C...+65°C
- Max. allowable working pressure PS:
46 bar (-10°C...+65°C)
25.9 bar (-45°C...-10°C)
- CE marking according PED



Selection Table

Type	Part No.	Connection Solder/ODF (mm) (inch)		Nominal Flow Capacity (kW)												Number of Blocks
				Pressure Drop 0.07 bar						Pressure Drop 0.14bar						
				R22	R134a	R404A R507	R407C	R410A	R744	R22	R134a	R404 R507	R407C	R410A	R744	
Conformity Assessment Cat. I, Procedure Module A																
FDH-485	880 300	16	5/8"	78	72	51	75	77	114	100	92	65	95	99	146	1
FDH-487	880 301	22	7/8"	145	133	95	138	143	211	182	167	119	174	180	265	
FDH-489	880 302		1 1/8"	204	187	133	195	202	297	262	240	171	250	258	380	
FDH-969	880 306		1 1/8"	250	229	163	239	247	364	300	275	196	286	296	436	2
FDH-9611	880 307	35	1 3/8"	305	279	199	291	301	443	402	369	262	384	397	585	

Note: Conditions for nominal capacities see previous page
For selection of other operating condition, please use Controls Navigator selection program.

Features Core

- Water capacities to suit specific system conditions
- Exceptional acid capacities for normal system protection, or to effectively clean-up following a compressor burnout (W48)



Core H48

Selection Table - Core for ADKS-Plus & FDH (to be ordered separately)

Size	Part No.	Water Adsorption Capacity (g)								Acid Adsorption Capacity (g)
		Liquid Temperature 24°C				Liquid Temperature 52°C				
		R134a	R22	R404A R507	R407C	R134a	R22	R404A R507	R407C	
S48	003 508	79.7	74.7	82.3	56.7	73.0	66.7	75.9	48.9	16.3
H48	006 969	35.0	31.7	37.0	24.4	29.0	24.5	28.9	18.1	44.6
W48	006 970	24.7	22.1	26.2	17.1	19.9	16.4	19.5	12.1	39.7
F48	006 973	Filter For Suction Line								
H100 / W100 are for Use with Phased-out ADKS-300/-400 Only										
H100	006 971	59.9	53.3	63.8	41.2	47.4	38.3	46.0	28.5	105.1
W100	006 972	52.7	47.1	56.0	36.4	42.4	34.7	41.4	25.7	85.5

Accessories and Spare Parts for ADKS & FDH

Description	Type	Part No.
ADKS, FDH		
Gasket Set	X 99961	003 710
Schrader Nipple 1/4" NPT	X 11562-2	803 251
Core Holder	X 99963	003 712

Filter-Drier Shells With Quick-Cap Series FDS-24 For Liquid- and Suction Applications With Replaceable Cores

Features

- Quick-cap flange (one bolt) design makes replacing of cores in a matter of seconds
- Ideal for retrofit, reducing installation / material cost
- Ideal for refrigerant recovery / reclaim units with regular change of filter-drier
- Free volume as a receiver in FDS-24... (580 cm³)
- ODF Copper fittings for easy brazing
- Corrosion-resistant powder painting of shell body
- Temperature range TS: -45°C...+65°C
Max. allowable working pressure PS:
34.5 bar (-10°C...+65°C)
25.9 bar (-45°C...-10°C)



FDS-24

Selection Table Suction Application

Type	Part No.	Connection		Nominal Flow Capacity (kW)												
		(mm)	(inch)	Block Core S24									Filter F24			
				R134a	R22	R407C	R507/R404A	R448A	R449A	R450A	R513A	R1234ze	R134a	R22	R407C	R507/R404A
FDS-245	003 573	16	5/8	22.3	30.6	28.5	26.0	65.1	63.8	62.7	59.8	59.9	24.7	33.9	31.5	28.8
FDS-247	003 574	22	7/8	32.2	44.1	44.1	37.5	97.4	95.4	93.8	89.4	89.7	37.8	51.8	48.2	44.0
FDS-249	003 575		1 1/8	46.0	63.0	58.6	53.6	98.5	96.5	94.9	90.4	90.7	50.7	69.4	64.5	59.0
FDS-249	003 576	28		44.2	60.5	56.3	51.4	99.0	97.0	95.3	90.9	91.1	48.6	66.9	61.9	56.6

Selection Table Liquid Application

Type	Part No.	Connection Solder/ODF		Nominal Flow Capacity (kW)													
		(mm)	(inch)	Pressure Drop 0.07 bar							Pressure Drop 0.14 bar						
				R22	R134a	R507/R404A	R407A	R407F	R407C	R410A	R22	R134a	R507/R404A	R407A	R407F	R407C	R410A
FDS-245	003 573	16	5/8	75	68	49	65	72	71	74	98	90	64	85	94	93	97
FDS-247	003 574	22	7/8	112	102	73	97	108	107	110	151	139	99	131	146	144	149
FDS-249	003 575		1-1/8	113	104	74	98	109	108	112	160	147	104	139	154	153	158
FDS-249	003 576	28		114	104	74	98	109	108	112	163	150	106	141	157	156	161

For selection of other operating condition, please use Controls Navigator selection program.

Selection Table Cores

Type	Part No.	Water Capacity in Grams at a Liquid Temperature of 24°C (52°C)			Application	Acid Adsorption Capacity (g)
		R134a	R22	R404A/R507		
S24	003 504	35.2 (32.3)	34.8 (29.5)	35.4 (32.1)	Liquid and Suction Line	8.9
W24	003 505	12.5 (9.2)	12.3 (8.9)	13.5 (10.4)	For Motor Burn-Out (Suction)	25.6
F24	003 506	- (-)	- (-)	- (-)	Filter for Suction Line	-

Note: Cores have to be ordered separately. 1 piece needed for FDS24 shell.

Accessories and Spare Parts for FDS

Description	Type	Part No.
Gasket Set	X 99967	003 716
O-Ring Set	X 99968	003 717
Core Holder	X 99969	003 718

Suction Line Filters and Filter Driers Series ASF and ASD Hermetic Design

Features

- Minimum pressure drop due to internal construction and compacted bead style
- Service-friendly with 2 Schrader valves for pressure drop measurement
- ODF Copper fittings for easy brazing
- Filtration down to 40 microns
- Temperature range TS: -45°C...+50°C
- Max. allowable working pressure PS: 27.5 bar
- CE marking not required acc. PED



ASF, ASD

Suction Line Filters

Type	Part No.	Connection Solder/ODF		Nominal Flow Capacity (kW)								
		(mm)	(inch)	R134a	R22	R404A	R407C	R507	R448A R449A	R450A	R513A	R507
ASF-28 S3	008 965		3/8	6	8.4	7.7	7.8	7.7	8.3	3.7	3.4	3.2
ASF-28 S4	008 941		1/2	9.9	14.4	13.4	13.4	13.4	13.7	6.5	5.9	5.6
ASF-35 S5	008 915	16	5/8	15.9	23.2	21.4	21.6	21.4	20.9	9.9	8.9	8.5
ASF-45 S6	008 946		3/4	23.3	34.5	32	32.1	32	25.2	13.3	12	11.4
ASF-45 S7	008 904	22	7/8	32.5	42.5	34.5	39.5	34.5	33.1	17.3	15.7	14.9
ASF-50 S9	008 908		1 1/8	46	67.1	55.5	62.4	55.5	47.5	24.8	22.5	21.3
ASF-75 S11	008 919	35	1 3/8	60.2	85.4	70.7	79.4	70.7	58.3	29.9	27.1	25.7
ASF-75 S13	008 940		1 3/8	65.4	87.5	73.1	81.4	73.1	62.2	31.6	28.7	27.2

Suction Line Filter Driers

Type	Part No.	Connection Solder/ODF		Nominal Flow Capacity (kW)								
		(mm)	(inch)	R134a	R22	R404A	R407C	R507	R448A R449A	R450A	R513A	R507
ASD-28 S3	008 909		3/8	5.5	8.1	7.4	7.5	7.4	8.6	4.1	3.7	3.5
ASD-28 S4	008 910		1/2	9.1	13.4	12.7	12.5	12.7	14.8	6.8	6.2	5.8
ASD-35 S5	008 899	16	5/8	14.3	20.4	19	19	19	23.7	11.2	10.2	9.6
ASD-45 S6	008 925		3/4	19.1	24.6	22.5	22.9	22.5	35.3	16.3	14.8	14
ASD-45 S7	008 896	22	7/8	25	32.3	26.4	30	26.4	43.2	22.8	20.7	19.6
ASD-50 S9	008 881		1 1/8	35.3	46.4	38.3	43.2	38.3	68.4	32.3	29.3	27.8
ASD-75 S11	008 891	35	1 3/8	42.9	56.9	47.8	52.9	47.8	57.6	40.8	37	35.1
ASD-75 S13	008 953		1 3/8	45.2	60.8	51	56.5	51	86.4	47.6	43.2	40.9

Nominal flow capacity at +4°C evaporating temperature (saturated condition/dew point) and a pressure drop of 0.21 bar between inlet and outlet of ASF/ASD. Correction factor for other evaporating temperatures than +4°C:

$$Q_n = Q_o \times K_s$$

- Q_n: Nominal Capacity
- K_s: Correction Factor for a Pressure Drop Corresponding 1 K Saturation Temperature
- Q_o: Required Cooling Capacity

For selection of other operating condition, please use Controls Navigator selection program.

Evaporating Temperature (°C)	+4	0	-5	-10	-15	-20	-25	-30	-35	-40
Correction Factor k _s	1.00	1.12	1.35	1.75	2.00	2.50	3.00	3.75	5.00	6.60

Water and Acid Adsorption Capacity

Type	Water Adsorption Capacity (g)										Acid Adsorption Capacity (g)
	Liquid Temperature 24°C					Liquid Temperature 52°C					
	R134a	R22	R404A R507	R407C	R410A	R134a	R22	R404A R507	R407C	R410A	
ASD-28	11.8	5.7	12.2	9.1	8.0	10.0	3.6	9.7	6.7	5.6	3.0
ASD-35	14.5	7.0	15.0	11.2	9.9	12.3	4.4	12.0	8.2	6.9	3.6
ASD-45	18.0	8.8	18.6	13.9	12.3	15.3	5.5	14.9	10.2	8.6	4.5
ASD-50	21.4	10.4	22.2	16.5	14.6	18.2	6.5	17.7	12.1	10.2	5.4
ASD-75	31.5	15.4	32.6	24.3	21.5	26.7	9.6	26.0	17.8	15.0	7.9

Suction Line Filter and Filter Drier Shells Series BTAS for Replaceable Filters and Filter Drier Cores

Features

- Corrosion-free brass body ideal for suction line applications
- Extremely large filtration area for optimum flow capacity
- Low pressure drop
- Filtration down to 40 micron
- Temperature range TS: -45°C ... +50°C
- Max. allowable working pressure PS: 24 bar
- UL/CUL: File Nr. SA3124



BTAS

Selection Table - Suction Line Shells With Filter Core

Type	Part No.	Connection Solder/ODF		Nominal Capacity Q _n (kW)									Filter Core		
		(mm)	(inch)	R134a	R22	R404A	R407C	R507	R448A R449A	R450A	R513A	R507	Type	Part No.	
CE marking not required acc. PED															
BTAS 25	015 353		5/8	12.5	17.1	13.9	15.9	13.9						A2F	009 907
BTAS 27	015 354	22	7/8	22.3	29.6	24.3	27.5	24.3	31.7	16.3	14.8	14.6			
BTAS 39	015 355		1 1/8	37.7	50.4	40.6	46.9	40.6	50.4	24.8	22.5	22.2	A3F	009 909	
BTAS 311	015 356	35	1 3/8	60.3	80.7	65.2	75.1	65.2	54.0	27.5	25.0	24.7			
BTAS 313	015 357		1 5/8	73.4	97.5	81.1	90.7	81.1	86.4	44.2	40.1	39.6			
BTAS 342	015 358	42		73.4	97.5	81.1	90.7	81.1	86.4	44.2	40.1	39.6			
BTAS 317	015 359	54	2 1/8	97.6	127.7	104.8	118.8	104.8	104.3	54.4	49.3	48.7	A4F	009 911	
BTAS 417	015 360	54	2 1/8	134.7	178.2	145.3	165.7	145.3	190.7	98.6	89.4	88.3			
CE Marked, Conformity Assessment Cat. I, Procedure Module A															
BTAS 521	015 361		2 5/8	209.0	282.4	229.8	262.6	229.8	302.2	153.0	138.7	137.0	A5F	009 913	
BTAS 525	015 362		3 1/8	260.1	346.1	283.9	321.9	283.9	370.6	190.4	172.6	170.4			
BTAS 580	015 363	80		260.1	346.1	283.9	321.9	283.9	370.6	190.4	172.6	170.4			

Note: Filter Core has to be Ordered Separately.

Selection Table - Suction Line Shells With Filter Drier Core

Type	Part No.	Connection Solder/ODF		Nominal Capacity Q _n (kW)									Filter Drier Core	
		(mm)	(inch)	R134a	R22	R404A	R407C	R507	R448A R449A	R450A	R513A	R507	Type	Part No.
CE marking not required acc. PED														
BTAS 25	015 353		5/8	11.6	15.5	12.8	14.3	12.8	16.6	8.5	7.7	7.6	A2F-D	009 908
BTAS 27	015 354	22	7/8	19.1	25.2	20.6	23.4	20.6	27.0	13.9	12.6	12.5		
BTAS 39	015 355		1 1/8	34.4	45.7	37.5	42.5	37.5	36.0	18.0	16.3	16.1	A3F-D	009 910
BTAS 311	015 356	35	1 3/8	49.2	65.5	53.7	60.9	53.7	50.4	25.2	22.8	22.5		
BTAS 313	015 357		1 5/8	57.1	77.3	62.5	71.9	62.5	72.0	37.4	33.9	33.5		
BTAS 342	015 358	42		57.1	77.3	62.5	71.9	62.5	72.0	37.4	33.9	33.5		
BTAS 317	015 359	54	2 1/8	77.1	94.1	77.7	87.5	77.7	82.8	40.8	37.0	36.5	A4F-D	009 912
BTAS 417	015 360	54	2 1/8	106.8	144.5	118.3	134.4	118.3	154.7	78.2	70.9	70.0		
CE marked, Conformity Assessment Cat. I, Procedure Module A														
BTAS 521	015 361		2 5/8	153.3	205.1	169.0	190.7	169.0	219.5	112.2	101.7	100.4	A5F-D	009 914
BTAS 525	015 362		3 1/8	181.2	242.0	199.4	225.1	199.4	259.1	132.6	120.2	118.7		
BTAS 580	015 363	80		181.2	242.0	199.4	225.1	199.4	259.1	132.6	120.2	118.7		

Note: Filter Drier Core has to be Ordered Separately.

Nominal capacity at +4°C evaporating temperature (saturated condition/ dew point) and a pressure drop of 0.21 bar between inlet and outlet of BTAS. Correction factor for other evaporating temperatures than +4°C:

$$Q_n = Q_o \times K_s$$

Q_n : Nominal capacity

K_s : Correction factor for a pressure drop corresponding 1K saturation temperature

Q_o : Required cooling capacity

Evaporating Temperature (°C)	+4	0	-5	-10	-15	-20	-25	-30	-35	-40
Correction Factor k_t	1.00	1.12	1.35	1.75	2.00	2.50	3.00	3.75	5.00	6.60

BTAS - Water and Acid Adsorption Capacity

Core	Water Adsorption Capacity (g)								Acid Adsorption Capacity (g)
	Liquid Temperature 24°C				Liquid Temperature 52°C				
	R134a	R22	R404A R507	R407C	R134a	R22	R404A R507	R407C	
A2F-D	2.8	2.5	2.9	4.8	2.3	1.9	2.3	5.0	3.7
A3F-D	7.6	6.8	8.0	13.3	6.3	5.3	6.2	13.8	10.3
A4F-D	14.8	13.3	15.7	25.9	12.2	10.3	12.2	26.9	20.1
A5F-D	21.8	19.6	23.1	38.2	18.0	15.1	17.9	39.7	29.6

Accessories and Spare Parts

Repair Kits with Cover, Screws and Gaskets	Type	Part No.
Repair Kit BTAS 2	KD 30519-2	065 970
Repair Kit BTAS 3	KD 30519-3	065 971
Repair Kit BTAS 4	KD 30519-4	065 972
Repair Kit BTAS 5	KD 30519-5	065 973

Moisture / Liquid Indicators AMI, MIA & CIA

MIA / CIA series with corrosion free stainless steel body and extended copper tube connections are fully hermetic products without the use of any gasket.

AMI is a highly serviceable product with exchangeable lens assembly and indicator element. available in various configurations including saddle type.

Features

- Maximum working Pressure PS:
 - AMI: 35 bar
 - MIA: 45 bar
 - CIA: 60 bar for subcritical CO2
- Media compatibility: R410A R134a R22 R404A R507 R407C R407A R407F R1234ze R448A R449A R450A R513A, R744 R124 R452A
- MIA/CIA: fully hermetic, low pressure drop
- Crystal indicator element for long lifetime and reliability
- Indication of dryness according to ASERCOM recommendation
- Easy determination of moisture content with calibrated four colors
- Large clear viewing area

Standards

- UL, CSA for Canada: certification File No.: SA 4876
- (MIA & AMI, except MIA-078 & AMI-3)
- **CE** Marking: AMI-2 /AMI-3 Series (MIA/CIA/ AMI-1 Series does not require)



MIA / CIA



AMI-1 TT







Selection Table - MIA

Type	Part No.	For tube outside diameter		Configuration	Picture
		(mm)	(inch)		
MIA M06	805880	6		ODM x ODM brazing	
MIA 014	805883		1/4		
MIA M10	805881	10			
MIA 038	805884		3/8		
MIA M12	805882	12			
MIA 012	805885		1/2		
MIA M16 / 058	805886	16	5/8		
MIA 078	805887	22	7/8		
MIA M28	805891	28			
MIA 118	805892		1 1/8		
MIA M10 S Female/Male	805888	10			
MIA M12 S Female/Male	805889	12			

Selection Table - MIA

Type	Part No.	For tube outside diameter		Configuration	Picture
		(mm)	(inch)		
CIA M06	805914	6		ODM x ODM brazing	
CIA 014	805910		1		
CIA M10	805915	10			
CIA 038	805911		3/8		
CIA M12	805916	12			
CIA 012	805912		1/2		
CIA M16 / 058	805913	16	5/8		

Selection Table - AMI

Type	Part No.	For tube outside diameter		Configuration	Picture
		(mm)	(inch)		
AMI-1 TT2 MM	805697	6		ODF x ODF brazing	
AMI-1 TT2	805655		1/4		
AMI-1 TT3 MM	805698	10			
AMI-1 TT3	805654		3/8		
AMI-1 TT4 MM	805699	12			
AMI-1 TT4	805653		1/2		
AMI-1 TT5	805652	16	5/8		
AMI-1 TT7	805656	22	7/8		
AMI-1 TT9 MM	805700	28			
AMI-1 TT9	805651		1 1/8		
AMI-1 SS2 MM	805732	6		ODF x ODF brazing	
AMI-1 SS2	805713		1/4		
AMI-1 SS3 MM	805733	10			
AMI-1 SS3	805714		3/8		
AMI-1 SS4 MM	805734	12			
AMI-1 SS4	805715		1/2		
AMI-1 SS5	805716	16	5/8		
AMI-1 SS7	805717	22	7/8		
AMI-1 SS9 MM	805703	28			
AMI-1 SS9	805705		1 1/8		
AMI-1 MM2	805706	6	1/4	Male flare x male flare	
AMI-1 MM3	805707	10	3/8		
AMI-1 MM4	805708	12	1/2		
AMI-1 MM5	805709	16	5/8		
AMI-1 FM2	805710	6	1/4		
AMI-1 FM3	805711	10	3/8	Female flare x male flare	
AMI-1 FM4	805712	12	1/2		
AMI-2 S11	805704	35	1 3/8		
AMI-2 S13	805659	42	1 5/8	Male solder ODM (for brazing into fittings)	
AMI-2 S17	805687	54	2 1/8		
AMI-3 S7	805650	22	7/8	Saddle type (for brazing onto the pipe)	
AMI-3 S9	805649	28	1 1/8		
AMI-3 S11	805648	35	1 3/8		

Accessories for AMI

Description	Type	Part No.
Lens assembly kit	X 12978-1	805742
O-Ring	X 99995	805643

Water Contents* by Indicator Color

Refrigerant	Liquid Temperature °C	Moisture content in mg Water per kg refrigerant (ppm)			
		Blue	Purple	Fushia:	Rose:
		Dry		Caution	Caution - Wet
R22	25	25	40	80	145
	38	35	65	130	205
	52	50	90	185	290
R404/R507	25	15	33	60	120
	38	25	50	110	150
	52	45	60	140	180
R134a	25	20	35	90	130
	38	35	55	120	160
	52	50	85	150	190
R407C	25	26	42	94	151
	38	40	68	144	232
	52	64	109	230	371
R410A (MIA)	25	30	50	110	165
	38	55	85	190	290
	52	75	120	270	420
R744 (CIA)	-40	3	5	10	16
	-20	6	10	20	32
	-10	8	14	29	46
	0	11	19	39	63
	5	13	22	46	75
	20	20	34	72	116

Note: In area "Caution" and "Caution wet" filter drier should be changed.







Oil Management and Liquid Level Monitoring Components

Technical Information

Refrigeration compressors are lubricated by refrigeration oil that circulates from the compressor crankcase or housing. As refrigerant gas is discharged by the compressor, it will leave a fine oil mist that will be circulated throughout the entire system. Small amounts of oil circulating through the system will not affect the system performance. Too much refrigeration oil circulating in the system will have adverse effects on the components in the system. Circulating oil reduces the ability of the system to effectively remove the heat. Condensers, evaporators and other heat exchangers lose efficiency when coated internally with an oil film.

Oil not returning to the compressor causes improper lubrication and eventual compressor failure. At low temperature application, oil thickness becomes difficult to move, causing oil to be trapped in the system.

Oil Separator Function

Refrigerant gas leaving the compressor through the discharge line contains refrigeration oil in a vaporous mist. As this mixture enters the oil separator, the velocity is reduced to allow oil separation to begin.

The refrigerant gas and oil mixture enters the oil separator and passes through an inlet screen, causing the fine particles to combine. Larger oil particles are formed and drop to the bottom of the oil separator.

The refrigerant gas then passes through an outlet screen to remove residual oil particles. The oil gathers in the bottom of the oil separator until a float operated needle valve opens to allow the return of oil to the compressor. Oil returns quickly to the compressor, because of the higher pressure in the oil separator than in the compressor crankcase. When the oil level has lowered, the needle valve retracts to prevent refrigerant gas from returning back to the compressor. The refrigerant gas leaves through the outlet of the oil separator and goes to the condenser.

Oil Level Management System Function

This system provides oil level balancing as well as oil level monitoring including alarm and compressor shut-down functions. The oil level is measured inside the compressor's crankcase. By operating an integrated solenoid valve, missing oil can be fed from the oil receiver or from the oil separator directly into the compressor sump. If the oil level drops to a dangerous level, the alarm contact changes into alarm state. The alarm contact may be used to shut down the compressor. The integrated electronics include delay times in order to avoid short-cycling and nuisance alarms.

This system applies to compressor pack applications with multiple parallel compressor arrangements, but also to stand-alone compressor applications for compressors without differential oil pressure monitoring.

Liquid Level Monitoring

LW4 and LW5 are self-contained units intended for liquid level monitoring at the sight glass or plugged connection of vessels, maintaining a permanent visibility of the liquid level versus other liquid level sensors. There are two versions for monitoring maximum or minimum liquid level. LW can be applied to a variety of media such as liquid refrigerants as well as oil.

The typical application are in liquid receivers, oil separators, oil reservoirs and flash tanks.



OM3, OM4 and OM5 TraxOil Oil Management

The Emerson TraxOil oil management is a self-contained and reliable electronically controlled system with an integrated solenoid valve, which feeds missing oil directly into the compressor sump. The sight glass function remains fully available, status and level information is indicated by LED's. The integrated alarm function with compressor shut down completes the overall proven solution for compressor protection.

While OM3 is the well-proven solution for HFC refrigerants, OM4 can also be used for subcritical CO₂ systems.

OM5 TraxOil has been specially developed for transcritical CO₂ applications, the new adapters are equipped with special types of O-rings to guarantee safe long-term and reliable operation.

Features

- OM3 for selected HFC and HFO/HFO blends refrigerants
 - max. working pressure PS: 46 bar (double point)
 - OM4 for liquid R744 (CO₂) subcritical and selected HFC and HFO/HFO blends refrigerants
 - max. working pressure double point PS 60 bar
 - OM5 for liquid R744 (CO₂) transcritical
 - max. working pressure double point PS 130 bar
 - max. operating pressure double point differential 100 bar
 - CO₂ optimized gasket material
 - Adapters with CO₂ optimized gasket material
 - High wattage ASC3-W coil to achieve high pressure differential MOPD of 100 bar
 - Self-contained unit with oil level sensor and integral solenoid to manage oil level supply
 - 3 Zone Level Control by using precise Hall-Sensor measurement, not prone to errors by foaming or light like optical sensors
 - Alarm, status and level indication by LED's
 - Supply 24 VAC or 230 VAC
 - SPDT output contact for compressor shut down or alarming, rating 230 VAC / 3 A
- Easy installation by sight-glass replacement and front side mounting without nuts
 - Adapters suitable for various types of compressors
 - Recommended by leading compressor manufacturers
 - **CE** marking under LVC and EMC Directive



OM5 + ASC3-W Coil 24V



OM4 + ASC Coil 230V + OM-230V

Selection Table OM3 and OM4 (Select One Item of Each Group)

1. Base Units (Supplied Without Adapter and Coil)

Type	Part No.	Max. Working Pressure PS (bar)	Time Delay Alarm
OM3-020	805 133	46 Bar	20 Sec
OM3-120	805 134		120 Sec
OM4-020	805135	60 Bar	20 Sec
OM4-120	805136		120 Sec



2. Adapter

OM0-CUA	805 037	Flange Adapter 3- / 4-Hole
OM0-CBB	805 038	Screw Adapter 1-1/8"-18 UNEF
OM0-CCA	805 039	Screw Adapter 3/4"-14 NPTF
OM0-CCB	805 040	Screw Adapter 1-1/8"-12 UNF
OM0-CCC	805 041	Flange Adapter 3-Hole
OM0-CCD	805 042	Rotalock Adapter 1-3/4"-12UNF
OM0-CCE	805 043	Rotalock Adapter 1-1/4"-12UNF

3. Cables Alarm Relay

OM3-N30	805 141	Connection to Relay 3 m
OM3-N60	805 142	Connection to Relay 6 m
OM3-N100	805 146	Connection to Relay 10 m

Supply Voltage 24V

4. Solenoid Coil

Type	Part No.	
ASC-24VAC	801062	50 Hz, 17VA

5. Cable Assembly Power Supply and Solenoid

OM3-P30	805 151	24V, 3 m
OM3-P60	805 152	24V, 6 m
OM3-P100	805 153	24V, 10 m

Supply Voltage 230V

4. Solenoid Coil

Type	Part No.	
ASC-230 VAC	801064	50 Hz, 17VA

5. Cable Assembly with 230V Module

OM-230V-3	805 163	230V, 3.0m
OM-230V-6	805 164	230V, 6.0m

Oil Management Kits Including Adapter and 24V Coil: Cross Reference

Kit Inc. Adapter	Part No.		Base Unit	Part No.	Adapter	Part No.	Coil	Part No.
OM3-CUA	805 301	➔	OM3-020	805133	OM0-CUA	805037	ASC 24 VAC	801 062
OM3-CBB	805 303				OM0-CBB	805038		
OM3-CCA	805 304				OM0-CCA	805039		
OM3-CCB	805 305				OM0-CCB	805040		
OM3-CCC	805 306				OM0-CCC	805041		
OM3-CCD	805 302				OM0-CCD	805042		
OM3-CCE	805 300				OM0-CCE	805043		
OM4-CUA	805 307		OM4-020	805 135	OM0-CUA	805 337	ASC 24 VAC	801062
OM4-CBB	805 309				OM0-CBB	805 338		
OM4-CCA	805 310				OM0-CCA	805 339		
OM4-CCB	805 311				OM0-CCB	805 340		
OM4-CCC	805 312				OM0-CCC	805 341		
OM4-CCD	805 308				OM0-CCD	805 342		
OM4-CCE	805 313				OM0-CCE	805 343		

Selection Table OM5 (Select One Item of Each Group)

1. Base Units (Supplied Without Adapter and Coil)

Type	Part No.	Max. working pressure PS (bar)	Time Delay Alarm
OM5-020	805230	130 Bar	20 Sec
OM5-120	805231		120 Sec



2. Adapter

OM0-CUA CO2	805337	Flange Adapter 3- / 4-Hole
OM0-CCC CO2	805341	Flange Adapter 3-Hole
OM0-CUD CO2	805049	Flange Adapter 6- / 6-Hole
OM0-CBB CO2	805338	Screw Adapter 1-1/8"-18 UNEF
OM0-CCA CO2	805339	Screw Adapter 3/4"-14 NPTF
OM0-CCB CO2	805340	Screw Adapter 1-1/8"-12 UNF
OM0-CCD CO2	805342	Rotalock Adapter 1-3/4"-12UNF
OM0-CCE CO2	805343	Rotalock Adapter 1-1/4"-12UNF

3. Cables Alarm Relay

OM3-N30	805 141	Connection to Relay 3 m
OM3-N60	805 142	Connection to Relay 6 m
OM3-N100	805 146	Connection to Relay 10 m

Supply Voltage 24V

4. Solenoid Coil

Type	Part No.	
ASC3-W24VAC	801074	50 Hz, 38 VA

5. Cable Assembly Power Supply and Solenoid

OM3-P30	805 151	24V, 3 m
OM3-P60	805 152	24V, 6 m
OM3-P100	805 153	24V, 10 m

Supply Voltage 230V

4. Solenoid Coil

Type	Part No.	
ASC3-W230VAC	801075	50 Hz, 38 VA

5. Cable Assembly with 230V Module

OM-230V-3	805 163	230V, 3 m
OM-230V-6	805 164	230V, 6 m

Accessories and Spare Parts

Type	Part No.	Description
ECT-623	804 421	Transformer 230 VAC / 24VAC, 60 VA (Supply of 3 Pieces Base Unit)
ASC3-K01	801 080	Retainer Kit ASC3 Including O-Rings
ODP-33A	800 366	Differential Oil Check Valve 3.5 bar, PS: 46 bar (Inlet 5/8"-UNF Female, Outlet 5/8"- UNF Male)
OM3-K01	805 036	Repair Kit OM3/OM4 (Consists of Sight Glass with O-Ring and Screws, Oil Adapter with Strainer, O-Ring Back Side)
OM5-K01	805 067	Repair Kit OM5 for CO2 (Consists of Sight Glass with O-Ring and Screws, Oil Adapter with Strainer, O-Ring Back Side)
OM-HFC-K01	805 081	Sealing Kit OM3/OM4 (Consists of all O-Rings for OM3/OM4 and for All Types of Adapters)
OM-HFC-K02	805 083	Enclosing Tube for OM3/OM4 (Including O-Ring), Only for Replacement of New Version with Hexagonal Nut!
OM-CO2-K01	805 079	Sealing Kit CO2 for OM5 (Consists of All O-Rings for Om5 and for All Types of Adapters)
OM-CO2-K02	805 082	Enclosing Tube for OM5 (Including O-Ring), Only for Replacement of New Version with Hexagonal Nut!

Technical Data

Markings:	CE Under: - Low Voltage Directive - EMC Directive
Max. Working Pressure PS:	OM3: 46 Bar OM4: 60 Bar OM5: HP Side (Inlet): 130 Bar LP Side (Outlet): 100 Bar
Max. Test Pressure PT:	OM3: 51 Bar OM4: 66 Bar OM5: 143 Bar
Supply Voltage / Total Power:	<ul style="list-style-type: none"> • With ASC-24VAC Coil • With ASC-230VAC Coil and OM-230V-x Module OM3/OM4: 24VAC, 50 Hz, ±10%, 17VA 230VAC, 50 Hz, ±10%, 17VA
	<ul style="list-style-type: none"> • With ASC3-W24VAC Coil • With ASC3-W230VAC Coil and OM-230V-x Module only OM5: 24VAC, 50 Hz, ±10%, 38VA 230VAC, 50 Hz, ±10%, 38VA
Solenoid Valve MOPD	OM3/OM4: 30 Bar OM5: 100 Bar (50Hz) See Fig. 1
Medium Temperature Ambient/Storage Temperature	-20...+80°C -20...+50°C
Medium Compatibility	OM3/OM4: R410A, R134a, R22, R404A, R507, R407C, R407A, R407F, R1234ze, R448A, R449A, R450A, R513A, R452A OM4/OM5: CO ₂ Mineral, Synthetic and Ester Lubricants

Flow Rate	OM3/OM4 at $\Delta P = 3$ Bar: 340g/Min. (22°C Oil Temperature, Oil type HM46) OM5: See Fig. 1
Orientation of Base Unit:	horizontal, +/- 1°
Level Control:	40% to 60% of Sight Glass Height
Alarm Contact:	Max. 3A, 230VAC SPDT Dry Contact
Time Delay Alarm:	20 Sec.: OM3/4/5-020, All OM3/4 Kits 120 Sec.: OM3/4/5-120
Time Delay Filling:	10 Sec.
Protection Class	IP 65 with plug/cable assembly acc. EN 60529 test conditions
Oil Connection	7/16"-20 UNF Male, with Strainer and O-Ring (Replaceable, See Acc.)
Enclosing Tube	Replaceable for Cleaning, Hexagon Wrench Size 18, See Spare Parts

Fig. 1: OM5: Performance Related to Supply Voltage: Flow Rate and Differential Pressure Between Inlet and Outlet (Oil Type Reniso C85E, Oil Temperature 54°C)

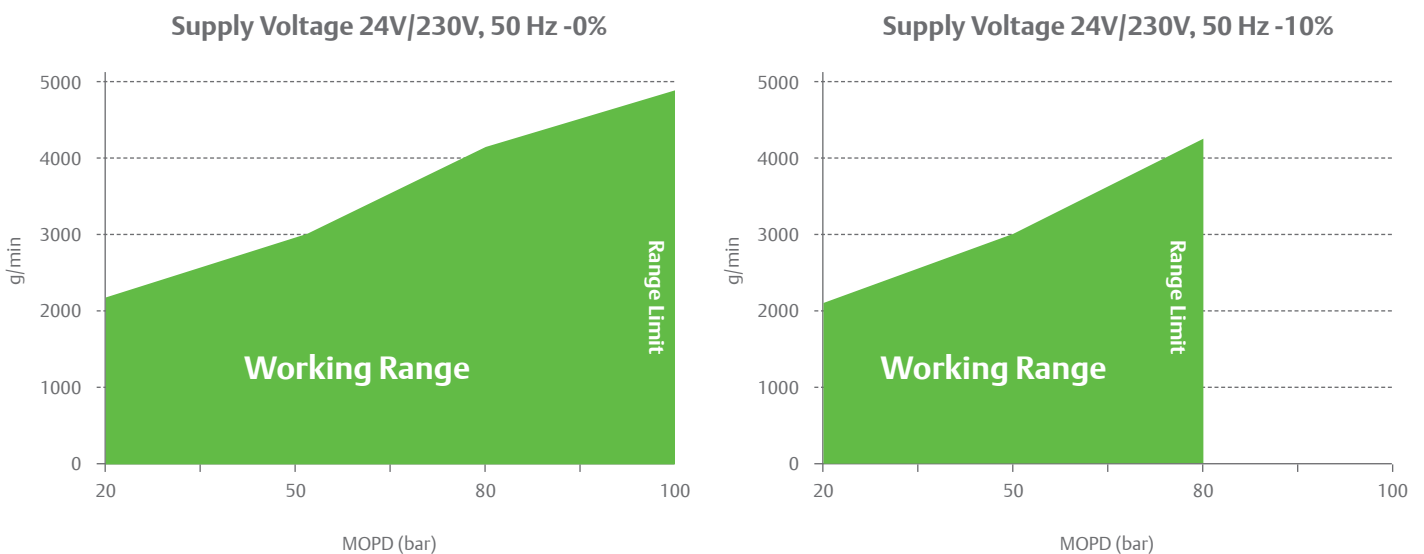



Electronic Oil Level Monitoring TraxOil™ OW4 and OW5

OW4 and OW5 TraxOil are intended for systems which require oil level monitoring and alarming instead of active oil level balancing.

Features

- OW4 for CO₂ subcritical and selected HFC and HFO/HFO blends refrigerants
max. working pressure PS: 60 bar
- OW5 for CO₂ transcritical
 - max. working pressure PS: 100 bar
 - CO₂ optimized gasket material, not released for HCFC and HFCs
 - Adapters with CO₂ optimized gasket material
- 3 Zone Level Control by using precise Hall-sensor measurement, not prone to errors by foaming or light like optical sensors
- Alarm, status and 3 zone indication by LED's
- SPDT output contact for compressor shut down or alarming, rating 230VAC / 3A
- Easy installation by sight-glass replacement and front side mounting without nuts
- Supply 24V AC, 50/60Hz
- Recommended by leading compressor manufacturers
- **CE** marking under Low Voltage and EMC Directive



OW4 TraxOil



OW5 TraxOil

Selection Table (Select One Item of Each Group)

1. Base Units (Supplied Without Adapter)

Type	Part No.	Max. Working Pressure	Time Delay Alarm
OW4-020	805 116	60 Bar	20 Sec

2. Adapter

OM0-CUA	805037	Flange Adapter 3-/4-Hole
OM0-CCC	805041	Flange Adapter 3-Hole
OM0-CBB	805038	Screw Adapter 1-1/8"-18 UNEF
OM0-CCA	805039	Screw Adapter 3/4"-14 NPTF
OM0-CCB	805040	Screw Adapter 1-1/8"-12 UNF
OM0-CCD	805042	Rotalock Adapter 1-3/4"-12UNF
OM0-CCE	805043	Rotalock Adapter 1-1/4"-12UNF

Compressor Models See OM3 Series.

3. Relay Cables

OM3-N30	805 141	Connection to Relay 3.0 m
OM3-N60	805 142	Connection to Relay 6.0 m
OM3-N100	805 146	Connection to Relay 10.0 m

4. Power Cables

Type	Part No.	Description	Cable Length
OW-24V-3	804 672	Connection to Power Supply 24VAC	3.0m

Product Selection (Select One Item of Each Group)

1. Base Units (Supplied Without Adapter)

Type	Part No.	Max. working Pressure PS (bar)	Time Delay Alarm
OW4-020	805 116	60 Bar	20 Sec

2. Adapter

OM0-CUA CO ₂	805 337	Flange Adapter 3-/4-Hole
OM0-CCC CO ₂	805 341	Flange Adapter 3-Hole
OM0-CUD CO ₂	805 049	Flange Adapter 6-/6-Hole
OM0-CBB CO ₂	805 338	Screw Adapter 1-1/8"-18 UNEF
OM0-CCA CO ₂	805 339	Screw Adapter 3/4"-14 NPTF
OM0-CCB CO ₂	805 340	Screw Adapter 1-1/8"-12 UNF
OM0-CCD CO ₂	805 342	Rotalock Adapter 1-3/4"-12UNF
OM0-CCE CO ₂	805 343	Rotalock Adapter 1-1/4"-12UNF

Compressor models see OM3 series.

3. Relay Cables

OM3-N30	805 141	Connection to Relay 3.0 m
OM3-N60	805 142	Connection to Relay 6.0 m
OM3-N100	805 146	Connection to Relay 10.0 m

4. Power Cables

Type	Part No.	Description	Cable Length
OW-24V-3	804 672	Connection to Power Supply 24VAC	3.0 m

Accessories and Spare Parts

Type	Part No.	Description
ECT-623	804 421	Transformer 230 VAC / 24 VAC, 60 VA (Supply of 3 Pieces Base Unit)
OM-HFC-K01	805 081	Sealing Kit OW4 (Consists of All O-Rings, Incl. Adapter Gaskets)
OM-CO2-K01	805 079	Sealing Kit OW5 (Consists of All O-Rings, Incl. Adapter Gaskets)

Technical Data

Markings:	CE Under: -Low Voltage Directive -EMC Directive
Max. Working Pressure PS: Max. Test Pressure PT:	OW4: 60 Bar OW5: 100 Bar OW4: 66 Bar OW5: 110 Bar
Supply Voltage Current	24VAC, 50/60Hz, ±10%, 0.05A
Medium Temperature Ambient/Storage Temperature	-20...80°C -20...50°C
Medium Compatibility	OW4: R410A, R134a, R22, R404A, R507, R407C, R407A, R407F, R1234ze, R448A, R449A, R450A, R513A, R452A, R744 OW5: CO ₂ Mineral, Synthetic and Ester Lubricants

Orientation of Base Unit: Level Control:	Horizontal, +/- 1° 40%...60% Sight Glass Height
Alarm Contact:	Max. 3 A, 230 VAC SPDT Dry Contact
Time Delay Alarm:	20 Sec or 120 Sec
Protection Class	IP 65 with plug/cable assembly acc. EN 60529 test conditions

Level Watch LW4 and LW5 Liquid Level Control

LW4 and LW5 are self-contained units intended for liquid level monitoring and control at the sight glass connection of vessels, maintaining a permanent visibility of the liquid level versus other liquid level sensors.

Features

- LW4 for liquid CO₂, selected HFC and HFO/HFO blends refrigerants and oil
 - Max. working pressure PS: 60 bar
- LW5 for liquid CO₂ and oil
 - Max. working pressure PS: 130 bar
 - CO₂ optimized gasket material, not released for HFCs
 - Adapters with CO₂ optimized gasket material
- Two Versions of each model:
 - LW4/5-H for high liquid level monitoring
 - LW4/5-L for low liquid level monitoring
- 3 Zone Level Control by using precise Hall-sensor measurement, not prone to errors by foaming or light like optical sensors
- Alarm, status and 3 zone indication by LED's
- Dual monitoring and protection:
- 24 V output signal for critical liquid levels
- SPDT output contact for alarming, rating 230 VAC / 3 A
- Easy installation by sight-glass replacement and front side mounting without nuts
- Supply 24 VAC, 50/60 Hz
- **CE** marking under LVD and EMC Directive



LW4



LW5

Selection Table (Select One Item of Each Group)

1. Base Units (Supplied Without Adapter)

Type	Part No.	Max. Working Pressure	Medium
LW4-H120	805491	60 Bar	HFC, CO ₂ , Oil
LW4-L120	805490	60 Bar	CO ₂ , Oil

2. Adapter

OM0-CUA	805037	Flange Adapter 3-/4-Hole
OM0-CCC	805041	Flange Adapter 3-Hole
OM0-CBB	805038	Screw Adapter 1-1/8"-18 UNEF
OM0-CCA	805039	Screw Adapter 3/4"-14 NPTF
OM0-CCB	805040	Screw Adapter 1-1/8"-12 UNF
OM0-CCD	805042	Rotalock Adapter 1-3/4"-12UNF
OM0-CCE	805043	Rotalock Adapter 1-1/4"-12UNF
LW0-1/2	805256	Screw adapter 1/2"-14 NPTF

3. Cables Alarm Relay

OM3-N30	805141	Connection to Relay 3.0m
OM3-N60	805142	Connection to Relay 6.0m
OM3-N100	805146	Connection to Relay 10.0m

4. Cable Power Supply

LW-24V-3	805500	Connection to Power Supply 24V AC 3.0m
LW-24V-6	805501	Connection to Power Supply 24V AC 6.0m
LW-24V-10	805502	Connection to Power Supply 24V AC 10.0m

Selection Table (Select One Item of Each Group)

1. Base Units (Supplied Without Adapter)

Type	Part No.	Max. Working Pressure	Medium
LW5-H120	805481	130 bar	CO ₂ , Oil
LW5-L120	805480	130 bar	CO ₂ , Oil

2. Adapter

LW0-CCA CO ₂	805254	Screw Adapter 3/4"-14 NPTF Steel
LW0-1/2 CO ₂	805257	Screw adapter 1/2"-14 NPTF

3. Cables Alarm Relay

OM3-N30	805141	Connection to Relay 3.0m
OM3-N60	805142	Connection to Relay 6.0m
OM3-N100	805146	Connection to Relay 10.0m

4. Cable Power Supply

LW-24V-3	805500	Connection to Power Supply 24V AC 3.0m
LW-24V-6	805501	Connection to Power Supply 24V AC 6.0m
LW-24V-10	805502	Connection to Power Supply 24V AC 10.0m

Accessories and Spare Parts

Type	Part No.	Description
ECT-623	804 421	Transformer 230 VAC / 24VAC, 60 VA
OM-HFC-K01	805 081	Sealing-Kit LW4 (Contains All Gaskets Incl. Adapter Gaskets)
OM-CO2-K01	805 079	Sealing-Kit LW5 for CO ₂ (Contains All Gaskets Incl. Adapter Gaskets)

Function

LW Liquid Level Monitoring Systems use a Hall-Sensor to measure the liquid levels. Unaffected from foaming oil or light a magnetic float changes its position according to the oil level. The hall sensor

converts these magnetic field changes into an equivalent signal, which is used by the integrated electronic controller to monitor the actual liquid level by LEDs.

Technical Data

Marking	CE Under: - Low Voltage Directive - EMC Directive
Max. Working Pressure PS: Max. Test Pressure PT:	LW4: 60 Bar LW5: 130 Bar LW4: 66 Bar LW5: 143 Bar
Supply Voltage Current	24 VAC, 50/60Hz, ±10%, 0.05A
Medium Temperature Ambient/Storage Temperature	-20...80°C -20...50°C
Medium Compatibility	LW4: R410A, R134a, R22, R404A, R507, R407C, R407A, R407F, R1234ze, R448A, R449A, R450A, R513A, R452A, R744 LW5: CO ₂ Mineral, Synthetic and Ester Lubricants

Orientation of Base Unit: Level Control:	Horizontal, +/- 1° 30%...60% Sight Glass Height
Alarm Contact:	Max. 3 A, 230 VAC SPDT Dry Contact
Output Signal	24 VAC Inductive Load: 35 VA
Time Delay Alarm:	120 Sec
Protection Class	IP 65 (IEC529/EN 60529)

Oil Separator Series OS

Features

- Three different construction styles:
 - Hermetic
 - Top flange
 - Bottom flange with support bracket
- Stainless steel needle valve and floater
- Permanent magnet to catch iron particles out of the system
- Corrosion-resistant epoxy powder coating
- ODF Copper fittings for easy brazing
- Temperature range TS: -10°C ... +150°C
- Max. allowable pressure PS: 31 bar
- **CE** marking according PED



OSH

OST

Type Code

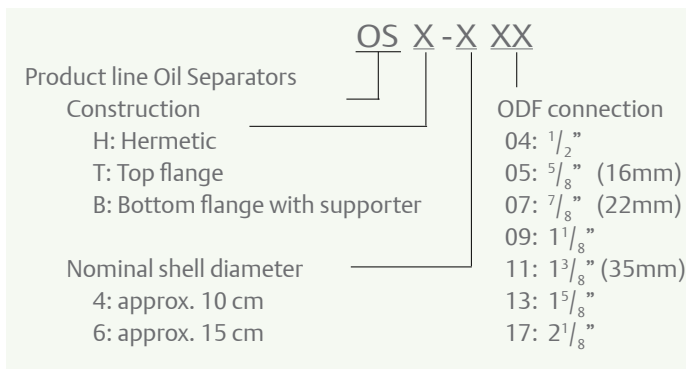

OSB

Selection Table

Type	Part No.	Connection		Conformity Assessment Category	Conformity Assessment Procedure	Nominal Capacity (kW)										Volume (l)
		(mm)	(inch)			R22/R407C	R134A	R404A/R507	R407A	R407F	R448A	449A	R1234ze	450A	513A	
OSH-404	881 598		1/2"	Cat. I	Module A*	7.0	4.9	7.3	6.5	6.3	7.4	7.9	3.9	4.6	4.7	2.0
OSH-405	881 599	16	5/8"			18.7	13.1	19.4	17.4	16.8	18.8	20.1	9.9	11.7	12.1	2.4
OSH-407	881 600	22	7/8"			28.1	19.7	29.0	26.1	25.3	29.9	32.1	15.8	18.6	19.2	2.8
OSH-409	881 792		1 1/8"			37.4	26.2	38.7	34.9	33.7	40.9	43.9	21.6	25.4	26.3	3.0
OSH-411	881 794	35	1 3/8"			46.8	32.8	48.4	43.6	42.1	49.3	52.9	26.0	30.7	31.7	3.6
OSH-413	881 856		1 5/8"			65.5	45.9	67.8	61.0	59.0	68.7	73.6	36.2	42.7	44.1	3.6
OSH-611	881 940	35	1 3/8"			Cat. II	Module D1	51.5	36.1	53.3	47.9	46.3	60.6	65.0	32.0	37.7
OSH-613	881 953		1 5/8"	65.5	45.9			67.8	61.0	59.0	71.7	76.8	37.8	44.5	46.0	7.9
OSH-642	889 022	42		65.5	45.9			67.8	61.0	59.0	-	-	-	-	-	7.9
OSH-617	881 970	54	2 1/8"	105.3	73.8			108.9	98.0	94.8	108.7	116.5	57.4	67.5	69.8	7.9
OST-404	881 860		1/2"	Cat. I	Module A*	7.0	4.9	7.3	6.5	6.3	7.4	7.9	3.9	4.6	4.7	1.8
OST-405	881 861	16	5/8"			18.7	13.1	19.4	17.4	16.8	18.8	20.1	9.9	11.7	12.1	2.6
OST-407	881 862	22	7/8"			28.1	19.7	29.0	26.1	25.3	29.9	32.1	15.8	18.6	19.2	3.2
OST-409	881 863		1 1/8"			37.4	26.2	38.7	34.9	33.7	40.9	43.9	21.6	25.4	26.3	3.8
OST-411	881 938	35	1 3/8"			46.8	32.8	48.4	43.6	42.1	49.3	52.9	26.0	30.7	31.7	3.8
OST-413	881 939		1 5/8"			65.5	45.9	67.8	61.0	59.0	68.7	73.6	36.2	42.7	44.1	3.8
OSB-613	881 971		1 5/8"			Cat. II	Module D1	65.5	45.9	67.8	61.0	59.0	71.7	76.8	37.8	44.5
OSB-617	881 972	54	2 1/8"	105.3	73.8			108.9	98.0	94.8	108.7	116.5	57.4	67.5	69.8	7.8

Note: *) Applied higher module as required



Suction Accumulators, Ball Valves and Oil Test Kit

Suction Accumulators

Features

- Hermetic design
- ODF Copper fittings for easy brazing
- Corrosion-resistant epoxy powder coating
- Internal orifice with strainer for optimum oil return
- Temperature range TS: -45°C...+65°C
- Max. allowable pressure PS:
20.7 bar (-10°C...+65°C)
15.5 bar (-45°C...-10°C)
- **CE** marking for certain types according PED
- UL/CUL file number: SA 10225



A08

Selection Table

Type	Part No.	Conne- ction		Nominal Capacity Q _n (kW)												Conformity Assessment		Volume (l)		
				R22/R407		R134a		R404A/ R507		R450A		R513A		R1234ze					R448A R449A	
		mm	Inch	Max.	Min.	Max.	Min.	Max.	Min.	Max.	Min.	Max.	Min.	Max.	Min.	Max.	Min.		Category	Procedure
A08-304	001 973		1/2	7.0	1.1	4.2	0.6	4.6	0.7	4.1	2.7	3.7	2.4	3.5	2.3	7.2	5.0	CE Marking Not Required		0.73
A10-305	001 977	16	5/8	10.5	1.6	6.0	0.9	7.0	1.1	5.8	4.1	5.2	3.7	5.0	3.5	10.8	7.5			0.93
A12-305	001 978	16	5/8	10.5	1.6	6.0	0.9	7.0	1.1	5.8	4.1	5.2	3.7	5.0	3.5	10.8	7.5			1.16
A12-306	001 979		3/4	14.0	2.1	8.1	1.2	9.1	1.4	7.8	5.4	7.1	4.9	6.7	4.6	14.4	10.0			1.16
A14-305	001 980	16	5/8	10.5	1.6	6.0	0.9	7.0	1.1	5.8	4.1	5.2	3.7	5.0	3.5	10.8	7.5			1.40
A14-306	001 987		3/4	14.0	2.1	8.1	1.2	9.1	1.4	7.8	5.4	7.1	4.9	6.7	4.6	14.4	10.0			1.40
A06-405	001 989	16	5/8	10.5	1.6	6.0	0.9	7.0	1.1	5.8	4.1	5.2	3.7	5.0	3.5	10.8	7.5			0.93
A10-405	001 990	16	5/8	10.5	1.6	6.0	0.9	7.0	1.1	5.8	4.1	5.2	3.7	5.0	3.5	10.8	7.5			1.75
A10-406	001 994		3/4	14.0	2.1	8.1	1.2	9.1	1.4	7.8	5.4	7.1	4.9	6.7	4.6	14.4	10.0			1.75



Selection Table (Continued)

Type	Part No.	Conne- ction		Nominal Capacity Q _n (kW)														Conformity Assessment		Volume (l)
				R22/R407		R134a		R404A/ R507		R450A		R513A		R1234ze		R448A R449A		Category	Procedure	
		Max.	Min.	Max.	Min.	Max.	Min.	Max.	Min.	Max.	Min.	Max.	Min.	Max.	Min.	Max.	Min.			
A09-506	881 995		3/4	14.0	2.1	8.1	1.2	9.1	1.4	7.8	5.4	7.1	4.9	6.7	4.6	14.4	10.0	Cat. I	Mod. D1	2.33
A09-507	882 455	22	7/8	25.6	3.8	14.0	2.1	16.1	2.4	13.6	9.5	12.3	8.6	11.7	8.1	26.3	18.2			2.73
A12-506	881 996		3/4	14.0	2.1	8.1	1.2	9.1	1.4	7.8	5.4	7.1	4.9	6.7	4.6	14.4	10.0			3.29
A12-507	881 998	22	7/8	25.6	3.8	14.0	2.1	16.1	2.4	13.6	9.5	12.3	8.6	11.7	8.1	26.3	18.2			3.29
A13-507	882 007	22	7/8	25.6	3.8	14.0	2.1	16.1	2.4	13.6	9.5	12.3	8.6	11.7	8.1	26.3	18.2			3.80
A13-509	882 011		1 1/8	41.4	6.2	25.3	3.8	26.7	4.0	24.5	17.0	22.2	15.3	21.0	14.4	42.5	29.6			3.80
A17-509	882 012		1 1/8	41.4	6.2	25.3	3.8	26.7	4.0	24.5	17.0	22.2	15.3	21.0	14.4	42.5	29.6			4.87
A17-511	882 013	35	1 3/8	66.0	9.9	37.6	5.6	42.8	6.4	36.4	24.8	33.0	22.3	31.3	21.0	67.6	47.0			4.87
A11-607	882 014	22	7/8	25.6	3.8	14.0	2.1	16.1	2.4	13.6	9.5	12.3	8.6	11.7	8.1	26.3	18.2			4.30
A13-607	882 015	22	7/8	25.6	3.8	14.0	2.1	16.1	2.4	13.6	9.5	12.3	8.6	11.7	8.1	26.3	18.2			4.98
A13-609	882 019		1 1/8	41.4	6.2	25.3	3.8	26.7	4.0	24.5	17.0	22.2	15.3	21.0	14.4	42.5	29.6			4.98
A14-611	882 020	35	1 3/8	66.0	9.9	37.6	5.6	42.8	6.4	36.4	24.8	33.0	22.3	31.3	21.0	67.6	47.0			5.48
A17-613	882 022		1 5/8	100.0	15.0	59.7	9.0	63.9	9.6	57.8	39.8	52.4	35.8	49.7	33.7	102.5	71.2			6.85
A17-642	889 023	42		100.0	15.0	59.7	9.0	63.9	9.6	57.8	39.8	52.4	35.8	49.7	33.7	102.5	71.2			6.85
A20-613	882 021		1 3/8	100.0	15.0	59.7	9.0	63.9	9.6	57.8	39.8	52.4	35.8	49.7	33.7	102.5	71.2			8.21
A25-613	882 023		1 5/8	100.0	15.0	59.7	9.0	63.9	9.6	57.8	39.8	52.4	35.8	49.7	33.7	102.5	71.2	Cat. II	Mod. D1	10.23

For selection of other operating conditions, please use "Controls Navigator" selection program

Ball Valves Series BVE/BVS and CVE/CVS

Features

- BVE/S, Max. working pressure PS: 45 bar
- CVE/S for CO₂, Max. working pressure PS: 60 bar
- BVS/CVS version with Schrader valve
- Two threads at valve body for easy mounting
- Hermetic design with Laser welded valve body
- Bi-directional flow characteristics
- Valve cap retained by strap attached to main body
- Pressure relief port design
- CE Marking acc. PED (from BVE-138 up to BVE-318)
- To protect valve from unauthorized use a special seal cap is available as accessory



Selection table BVE/BVS (UL Approved)

Type BVE	Part No.	Type BVS	Part No.	Connection size ODF	
				(inch)	(mm)
BVE-014	806 730	BVS-014	806 750	1/4"	
BVE-M06	806 731	BVS-M06	806 751		6mm
BVE-038	806 732	BVS-038	806 752	3/8"	
BVE-M10	806 733	BVS-M10	806 753		10mm
BVE-012	806 734	BVS-012	806 754	1/2"	
BVE-M12	806 735	BVS-M12	806 755		12mm
BVE-058	806 736	BVS-058	806 756	5/8"	16mm
BVE-034	806 737	BVS-034	806 757	3/4"	
BVE-078	806 738	BVS-078	806 758	7/8"	22mm
BVE-118	806 739	BVS-118	806 759	1 1/8"	
BVE-M28	806 740	BVS-M28	806 760		28mm
BVE-138	806 741	BVS-138	806 761	1 3/8"	35mm
BVE-158	806 742	BVS-158	806 762	1 5/8"	
BVE-M42	806 743	BVS-M42	806 763		42mm
BVE-218	806 744	BVS-218	806 764	2 1/8"	54mm
BVE-258	806 745	BVS-258	806 765	2 5/8"	
BVE-318	806746	BVS-318	806766	3 1/8"	

Selection table CVE/CVS (Not UL Approved)

Type CVE	Part No.	Type CVS	Part No.	Connection size ODF	
				(inch)	(mm)
CVE-014	808 130	CVS-014	808 150	1/4"	
CVE-M06	808 131	CVS-M06	808 151		6mm
CVE-038	808 132	CVS-038	808 152	3/8"	
CVE-M10	808 133	CVS-M10	808 153		10mm
CVE-012	808 134	CVS-012	808 154	1/2"	
CVE-M12	808 135	CVS-M12	808 155		12mm
CVE-058	808 136	CVS-058	808 156	5/8"	16mm
CVE-034	808 137	CVS-034	808 157	3/4"	
CVE-078	808 138	CVS-078	808 158	7/8"	22mm

Technical Data

Max. Allowable Pressure PS	BVE/BVS 45 Bar; CVE/CVS 60 Bar
Test Pressure PT	BVE/BVS 49.5 Bar; CVE/CVS 66 Bar
Medium Temperature TS	-40 ... 120°C
Medium Compatibility	R410A R134a R22 R404A R507 R407C R407A R407F R1234ze R448A R449A R450A R513A R744 R124 R452A

Accessories - Special Seal Caps

BVE / BVS , CVE / CVS Valve Size	Part No.	Thread (3)	Quantity Per Pack
1/4" ... 7/8" (6 ... 22mm)	806 770	M18x1	10 pcs
1-1/8" ... 1 3/8" (28 ... 35mm)	806 771	M27x1	10 pcs
1-5/8" (42 mm) ... 3-1/8"	806 772	M36x1	10 pcs





Appendix

Appendix Conversion Table

Power

$\text{kW} / \text{h} = \text{Kcal} / \text{h} : 860$	$\text{Kcal} / \text{h} = \text{kW} / \text{h} \times 860$
$\text{kW} = \text{US Ton of Refrigeration} : 0.284$	$\text{US Ton of Refrigeration} = \text{kW} \times 0.284$
$\text{kW} = \text{BTU} / \text{h} : 3413$	$\text{BTU} / \text{h} = \text{kW} \times 3413$

Temperature

$^{\circ}\text{C} = (^{\circ}\text{F} - 32) : 1.8$	$^{\circ}\text{F} = (^{\circ}\text{C} \times 1.8) + 32$
--	---

Pressure

$\text{Bar} = \text{PSI} : 14.5$ $1 \text{ Bar} = 100\,000 \text{ Pascal}$	$\text{PSI} = \text{Bar} \times 14.5$ $100 \text{ Pascal} = 1 \text{ m Bar}$
---	---



Connections

Specification		Connection Tube			Thread
		SAE	Inch	Metric	
SAE	Flare	SAE 1/4"	1/4"	6mm	7/16" - 20UNF
		SAE 5/16"	5/16"	8mm	5/8" - 18UNF
		SAE 3/8"	3/8"	10mm	5/8" - 18UNF
		SAE 1/2"	1/2"	12mm	3/4" - 16UNF
		SAE 5/8"	5/8"	16mm	7/8" - 14UNF
		SAE 3/4"	3/4"	18mm	1 1/16" - 14UNF
		SAE 7/8"	7/8"	22mm	1 1/4" - 12UNF
		SAE 1"	1	25mm	1 1/2" - 12UNF
			1 1/8"		
			1 3/8"	35mm	
			1 5/8"		
			2 1/8"	54mm	
			2 5/8"		
	3 1/8"				
R or G same as BSP	Pipe thread female cylindrical	Male Thread: R / NPT / BSP / G			Withworth-Pipe Thread DIN 2999 / ISO 228
R same as BSP	Pipe Thread Male Tapering	Female Thread: R / NPT / BSP / G			Withworth-Pipe Thread DIN 2999
G	Pipe Thread Male Cylinder	Female thread: R / BSP / G			Withworth-Pipe Thread ISO 228
NPT	Pipe Thread Female Tapering	Male thread: R / NPT / BSP			Standard Taper Pipe Thread ASA B 2.1
	Pipe Thread Male Tapering	Female thread: R / NPT / BSP / G			
ODF Outside Diameter Female	Solder Female	Given dimension is outside tube diameter. Tube has to be pushed into odf connection.			
ODM Outside Diameter Male	Solder Male	Given dimension is outside tube diameter. Expanded tube can be pushed onto odm connection or tube can be connected through a sleeve with the odm connection.			

CE Per Pressure Vessel Directive 14/68/EU

Product	Fluid Group	Volume (Liter)	TS (°C)	PS (bar)	Hazard Category	Conformity Assessment Module	Marking
Filter Driers							
ADK-03 / 05 / 08 / 16...	II	0.1 ... 0.38	-40 ... +65	45	SEP	-	HP & UL
ADK-30 / 41 / 75...	II	0.4 ... 0.65			SEP	-	HP & UL
FDB-03 / 05 / 08 / 16...	II	0.1 ... 0.38			SEP	-	HP & UL
FDB-30 / 41...	II	0.45 ... 0.5			SEP	-	HP & UL
BFK-05 / 08 / 16...	II	0.18 ... 0.32			SEP	-	HP & UL
BFK-30...	II	0.4			SEP	-	HP & UL
FDS-24...	II	1.0	-10 ... +65 (-45 ... -10)	34.5 (25.9)	SEP	-	HP & UL
ADKS-48...	II	2.1			I	A	CE & UL
ADKS-96...	II	3.8			I	A	CE & UL
ADKS-144...	II	5.4			I	A	CE & UL
ADKS-192...	II	7.0			I	D1	CE0036 & UL
ASD/ASF-28.../35.../45...	II	<1.0	-45 ... +50	27.5	SEP	-	HP & UL
ASD/ASF50.../75...	II	<1.4			SEP	-	HP & UL
BTAS-2...	II	0.42	-45 ... +50	24	SEP	-	HP & UL
BTAS-3...	II	1.1			SEP	-	HP & UL
BTAS-4...	II	1.97			SEP	-	HP & UL
BTAS-5...	II	3.19			I	A	CE & UL
Oil Management / Components							
OSH-404	II	2.0	-10 ... +150	31	I	A	HP & UL
OSH-405	II	2.4			I	A	HP & UL
OSH-407	II	2.8			I	A	HP & UL
OSH-409	II	3.0			I	A	HP & UL
OSH-411 / -413	II	3.6			I	A	HP & UL
OST-404	II	1.8			I	A	HP & UL
OST-405	II	2.6			I	A	HP & UL
OSH-407	II	3.2			I	A	CE & UL
OST-409 / -411 / -413	II	3.8			I	A	CE & UL
OSH-611	II	6.5			II	D1	CE & UL
OSH-613 / -617	II	7.9			II	D1	CE0036 & UL
OSB-613 / -617	II	7.8			II	D1	HP & UL
OM3	II	DN 6MM			-20 ... +80	35	SEP
OM4 & OW4	II	DN 6MM	-20 ... +80	60	SEP	CE under Low Voltage and EMC Directive	
Suction Accumulators							
A08-304	II	0.9	-10 ... +65 (-45 ... 10)	20.7 (15.5)	SEP	-	HP & UL
A10-305	II	1.1			SEP	-	HP & UL
A12-305 / -306	II	1.3			SEP	-	HP & UL
A14-305 / -306	II	1.6			SEP	-	HP & UL
A06-404 / -405	II	1.2			SEP	-	HP & UL
A10-405 / -406	II	2.1			SEP	-	HP & UL
A09-506 / -507	II	2.7			I	A	CE & UL
A12-506 / -507	II	3.8			I	A	CE & UL
A13-507 / -509	II	4.3			I	A	CE & UL
A17-509 / -511	II	5.4			I	A	CE & UL
A11-607	II	5.1			I	A	CE & UL
A13-607 / -609	II	5.8			I	A	CE & UL
A14-611	II	6.4			I	A	CE & UL
A17-613	II	7.9			I	A	CE & UL
A20-613	II	9.4			I	A	CE & UL
A25-613	II	11.6			II	D1	CE0036 & UL

CE Per Pressure Vessel Directive 14/68/EU

Product	Fluid Group	Volume (Liter)	TS (°C)	PS (bar)	Hazard Category	Conformity Assessment Module	Marking
Pressure Switches							
PS1-B3..., PSA-B3...		6	-50 ... +70	22	IV	B, D	CE0035 & UL
PS1-S3..., PSA-S3...		6			IV	B, D	CE0035 & UL
PS1-W3..., PSA-W3...		6			IV	B, D	CE0035 & UL
PS1-B5..., PSA-B5...		6		32	IV	B, D	CE0035 & UL
PS1-S5..., PSA-S5...		6			IV	B, D	CE0035 & UL
PS1-W5..., PSA-W5...		6			IV	B, D	CE0035 & UL
All Other PS1 Types		6	22/32	Under LVD, Excluded from PED		CE & UL	
PS2-B7..., PSB-B7...		6	50 ... +70	22	IV	B, D	CE0035 & UL
PS2-C7..., PSB-C7...		6			IV	B, D	CE0035 & UL
PS2-T7..., PSB-T7...		6			IV	B, D	CE0035 & UL
PS2-B7..., PSB-B7...		6		32	IV	B, D	CE0035 & UL
PS2-C7..., PSB-C7...		6			IV	B, D	CE0035 & UL
PS2-C8..., PSB-C8...		6			IV	B, D	CE0035 & UL
PS2-G8..., PSB-G8...		6			IV	B, D	CE0035 & UL
PS2-S8..., PSB-S8...	6	IV			B, D	CE0035 & UL	
PS2-T7..., PSB-T7...	6	IV			B, D	CE0035 & UL	
PS2-W7..., PSB-W7...	6	IV		B, D	CE0035 & UL		
All Other PS2 Types	6	22/32		Under LVD, Excluded from PED		CE	
PS3-B.1...,PS3-W.1...	6	-40 ... +70		27	IV	B, D	CE0035 & UL
PS3-B.4...,PS3-S.4...	6	-40 ... +70	32	IV	B, D	CE0035 & UL	
PS3-B.5...,PS3-S.5...	6			IV	B, D	CE0035 & UL	
PS3-W.4...,PS3-W.5...	6			IV	B, D	CE0035 & UL	
PS3-C.4...,PS3-T.4...,PS3-X.4...	6	-40 ... +150	43	IV	B, D	CE0035 & UL	
PS3-C.5...,PS3-T.5...,PS3-X.5...	6			IV	B, D	CE0035 & UL	
PS3-B6...,PSC-B6...	6	-40 ... +150	43	IV	B, D	CE0035 & UL	
PS3-W6...,PSC-W6...	6			IV	B, D	CE0035 & UL	
PS3-S6...,PSC-S6...	6			IV	B, D	CE0035 & UL	
All Other PS3 Type	6	-40 ... +70	27/32	Under LVD, Excluded from PED		CE	
PS4-W..., PS4-BL...	6	-30 ... +80	25/41/55/69	IV	B, D	CE	
FD113...	6	Under LVD, Excluded from PED				CE & UL	

LVD = Low Voltage Directive

CE Per Pressure Vessel Directive 14/68/EU

Product	Fluid Group	DN (mm)	TS (°C)	PS (bar)	Hazard Category	Conformity Assessment Module	Marking
Fan Speed Controllers							
FSY-41...	II	6	-20 ... +70	27	Under LVD, Excluded from PED		CE
FSY-42...	II	6		32			CE
FSY-43...	II	6		43			CE
Transmitters							
PT5-07M/T	II	6	-40 ... +80 Mobile Applic.:	27	SEP	-	CE
PT5-18M/T	II	6		55	SEP	-	CE
PT5-30M/T	II	6	-25 ... +80	60	SEP	-	CE
PT5-50M/T	II	6		100	SEP	-	CE
PT5-150D	II	6	-40 ... +80	150	SEP	-	CE
Thermo™ Expansion Valves and Electrical Control Valves							
TI	II	Max. 16	-45 ... +65	45	SEP	-	-
TX3	II	Max. 16		45	SEP	-	-
TX6-H/M/N/S..	II	Max. 22		31	SEP	-	-
TX6-Z..	II	Max. 22		42	SEP	-	-
T-Series with XB / XC Power Element	II	Max. 28		46 / 31	SEP	-	-
L-Series with XB / XC Power Element	II	Max. 28		46 / 31	SEP	-	-
935-Series with XB / XC Power Element	II	Max. 28	46 / 31	SEP	-	-	
ZZ-Series	II	Max. 28	-120 ... +65	31	SEP	-	-
EX2	II	Max. 12	-40 ... +50	40	SEP	-	-
EX4/EX5/EX6	II	Max. 22	-50 ... +100	45	SEP	-	-
EX7	II	35		45	I	A	CE
EX8	II	42		45	I	A	CE
Solenoid Valves							
110 RB 2...	II	6...10	--40 ... +120	31	SEP	-	-
200 RB 3/4/6...	II	10 ... 16		31	SEP	-	-
200 RH 3-6T4/6T5	II	10 ... 16		60/50	SEP	-	-
240 RA 8/9/12...	II	16 ... 28		31	SEP	-	-
240 RA 16T9	II	28		31	SEP	-	-
240 RA 16T11	II	35		31	I	A	CE
240 RA 20T11/13/17...	II	35 ... 54		31	I	A	CE
540 RA 8/9/12/16...	II	16 ... 28		31	SEP	-	-
540 RA 20T11	II	35 ... 54		28	SEP	-	-
M36-078	II	28	-40 ... +120	35	SEP	-	-
M36-118	II	28		35	SEP	-	-
Regulators							
ACP	II	6...10	--40 ... +120 -30... +80	31	SEP	-	-
CPHE...	II	12 ... 28		28	SEP	-	-
PRE/PRC	II	16 ... 35		25	SEP	-	-
Ball Valves							
BVE/BVS...	II	≤ 28	--40 ... +120	45	SEP	-	-
BVE/BVS....	II	≥ 35		45	I	A	CE





Alco Keyword Register

Alco Keyword Register

Series	Description	Page
110 RB	2-Way Solenoid Valve	230
200 RB	2-Way Solenoid Valve	230
200 RH	2-Way Solenoid Valve	230
240 RA	2-Way Solenoid Valve	230
540 RA	2-Way Solenoid Valve	232
935	Liquid Injection Valve	224
A	Suction Accumulators	296
ACP	Hot Gas Bypass Regulator	237
ADK	Filter Drier	264
ADKS-Plus	Filter Drier Shell	273
AMI	Moisture/Liquid Indicator	280
ASC3	Coils	300
ASF	Suction Line Filter	277
ASD	Suction Line Filter Drier	277
B		
BFK	Bi-Flow Filter Drier	266
BTAS	Suction Line Filter and Filter Drier Shell	278
BVE / BVS, CVE / CVS	Ball Valves	296

Series	Description	Page
C		
CPHE	Hot Gas Bypass Regulator	238
CSS	Compressor Soft Starter	199
CS3	Pressure Controls (High Pressure)	261
CX2	Electronic Expansion Valve	177
E		
EC2-5	Condenser and Condensing Unit Controller	184
EC3-3	Coldroom Controller	197
EC3-D72/D73	Digital Superheat Controllers	187
EC3-X32/X33	Superheat Controllers	187
EX2	Electronic Expansion Valve	176
EX4 .. EX8	Electrical Control Valves	178
EXD-HP1/2	Stand-alone Superheat/Economizer Controller	191
EXD-SH1/2	Superheat Controller for EX/CX Valves	189
EXD-TEVI	Economizer Controller for Tandem Compressors	193
EXD-U	Universal Driver Modules	194
EXM/EXL	Electronic Expansion Valve	174



Alco Keyword Register

Series	Description	Page
F		
FD 113	Differential Pressure Controls	256
FDB	Filter Driers	270
FDH	Filter Drier Shell	275
FDS-24	Filter-Drier Shells With Quick-Cap	276
FSE	Fan Speed Control Module	204
FSY	Electronic Fan Speed Controller	202
FX	Electronic Expansion Valve	180
L	Liquid Injection Valve	224
LW4/5	Level Watch LW4 and LW5	292
L-Series	Thermo Expansion Valve	222
M		
M36	3-Way Solenoid Valve	234
MIA / CIA	Moisture/Liquid Indicator	280
O		
OM3 / OM4 / OM5	Oil Level Management System	285
OW4 / OW5	Electronic Oil Level Monitoring	290
OS	Oil Separator	294

Series	Description	Page
P		
PRC	Crankcase Pressure Regulator	240
PRE	Evaporator Pressure Regulator	239
PS1	Pressure Controls	244
PS2	Dual Pressure Controls	246
PS3	Pressure Controls	248
PS4	Pressure Controls	263
PT5	Pressure Transmitter	200
T		
TI	Thermo Expansion Valve	206
T-Series	Thermo Expansion Valve	217
TS1	Thermostat	259
TX3	Thermo Expansion Valve	208
TX7	Thermo Expansion Valve	214
Z		
ZZ	Thermo Expansion Valve	220

Notes

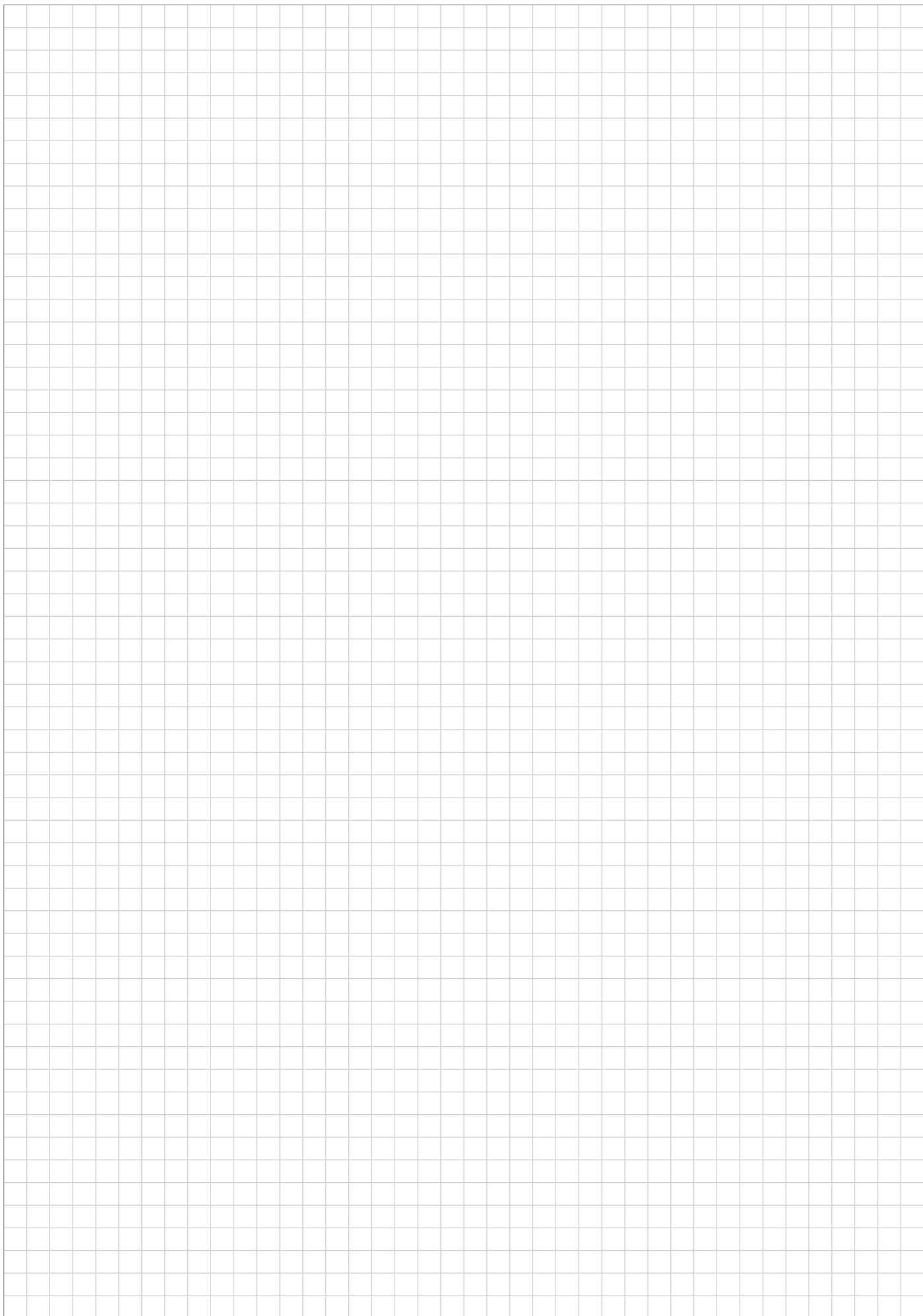

Notes

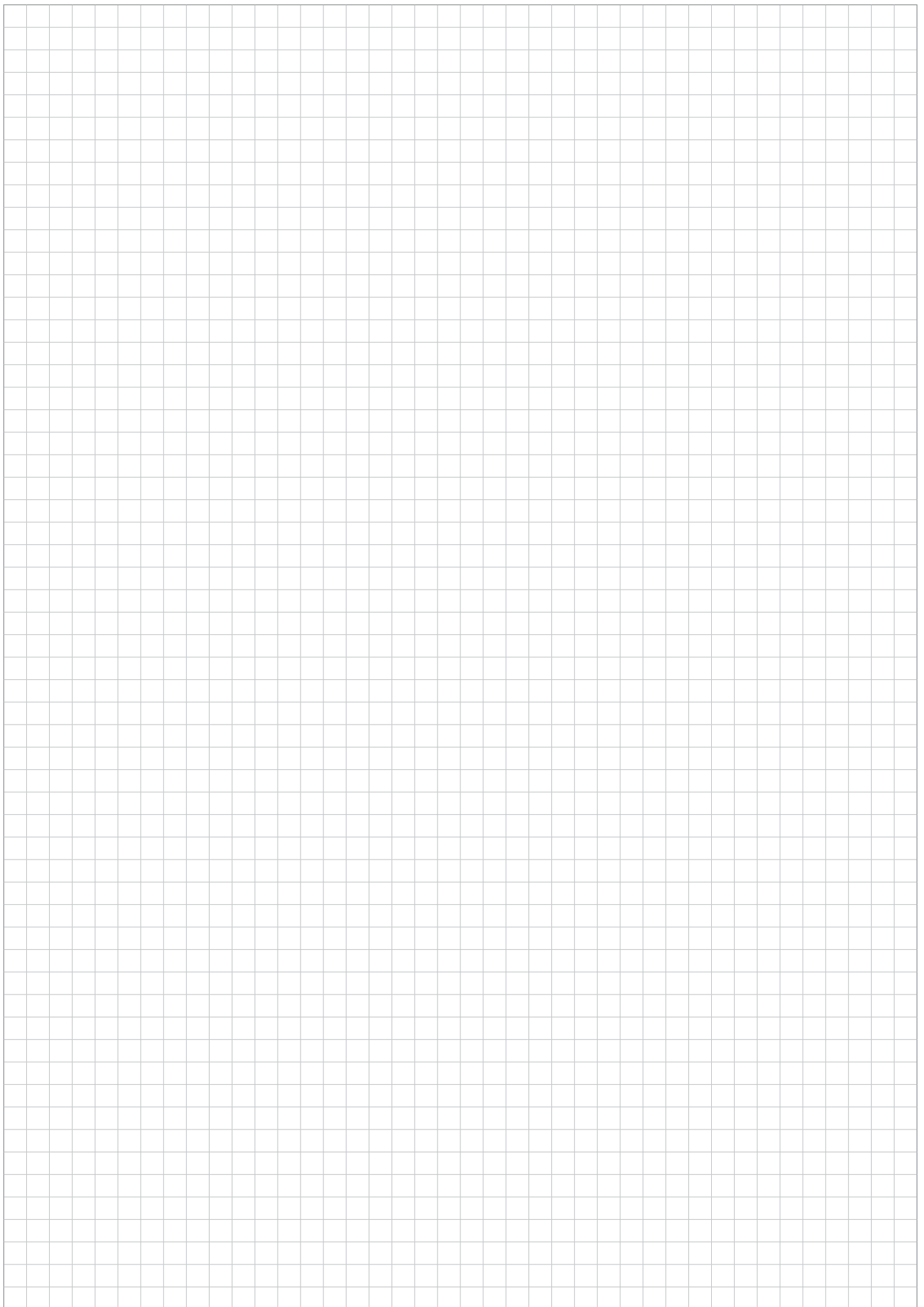

Standard Terms and Conditions of Sale – Products & Services

1. DEFINITIONS:

In these Terms and Conditions of Sale, "Seller" means one of the three Emerson companies mentioned in the title; "Buyer" means the person, firm, company or corporation by whom the order is given; "Goods" means the goods (including any Software and Documentation, as defined in Clause 9) described in Seller's Acknowledgement of Order form; "Services" means the services described in Seller's Acknowledgement of Order Form; "Contract" means the written agreement (including these Terms and Conditions) made between Buyer and Seller for the supply of the Goods and/or provision of Services; "Contract Price" means the price payable to Seller by Buyer for the Goods and/or Services and "Seller Affiliate" means an Emerson Group company which is an affiliate within the meaning of Section 15 AktG (German Stock Corporation Act).

2. THE CONTRACT:

2.1 All orders must be in writing and are accepted subject to these Terms and Conditions of Sale. No terms or conditions put forward by Buyer and no representations, warranties, guarantees or other statements not contained in Seller's quotation or Acknowledgement of Order nor otherwise expressly agreed in writing by Seller shall be binding on Seller.

2.2 The Contract shall become effective only upon the date of acceptance of Buyer's order on Seller's Acknowledgement of Order form. If the details of the Goods or Services described in Seller's quotation differ from those set out in the Acknowledgement of Order Form the latter shall apply.

2.3 No alteration or variation to the Contract shall apply unless agreed in writing by both parties. However, Seller reserves the right to effect minor modifications and/or improvements to the Goods before delivery provided that the performance of the Goods is not adversely affected and that neither the Contract Price nor the delivery date is affected.

3. VALIDITY OF QUOTATION AND PRICES:

3.1 Unless previously withdrawn, Seller's quotation is open for acceptance within the period stated therein or, when no period is so stated, within thirty days after its date.

3.2 Prices are firm for delivery within the period stated in Seller's quotation and are exclusive of (a) Value Added Tax and (b) any similar and other taxes, duties, levies or other like charges arising outside Germany in connection with the performance of the Contract.

3.3 Prices (a) are for Goods delivered EXW (Ex works) Seller's shipping point, exclusive of freight, insurance and handling and (b) unless otherwise stated in the Seller's quotation, are exclusive of packing. If the Goods are to be packed, packing materials are non-returnable.

4. PAYMENT:

4.1 Payment shall be made: (a) in full without set-off, counterclaim or withholding of any kind (save where and to the extent that this cannot by law be excluded); and (b) in the currency of Seller's quotation within thirty days of receipt of invoice unless otherwise specified by Seller's Finance Department. Goods will be invoiced at any time after their readiness for dispatch has been notified to Buyer. Services will be invoiced monthly in arrears or, if earlier, upon completion. Without prejudice to Seller's other rights, Seller reserves the right to: (i) charge interest on any overdue sums at 8% above the base lending rate of Section 247 BGB (German Civil Code) during the period of delay; (ii) suspend performance of the Contract (including withholding shipment) in the event that Buyer fails or in Seller's reasonable opinion it appears that Buyer is likely to fail to make payment when due under the Contract or any other contract; and (iii) under the same conditions require reasonable security for payment.

4.2 Customer may set off counterclaims only if recognized or non-appealable. A right of retention may be exercised by Customer only if as it concerns the same contractual relationship.

5. DELIVERY PERIOD:

5.1 Unless otherwise stated in Seller's quotation, all periods stated for delivery or completion run from the Effective Date and are to be treated as estimates only not involving any contractual obligations.

5.2 If Seller is delayed in or prevented from performing any of its obligations under the Contract due to the acts or omissions of Buyer or its agents (including but not limited to failure to provide specifications and/or fully dimensioned working drawings and/or such other information as Seller reasonably requires to proceed expeditiously with its obligations under the Contract), the delivery/completion period and the Contract Price shall both be adjusted accordingly.

5.3 If delivery is delayed due to any act or omission of Buyer, or if having been notified that the Goods are ready for dispatch, Buyer fails to take delivery or provide adequate shipping instructions, Seller shall be entitled to place the Goods into a suitable store at Buyer's expense. Upon placing the Goods into the store, delivery shall be deemed to be complete, risk in the Goods shall pass to Buyer and Buyer shall pay Seller accordingly.

6. FORCE MAJEURE:

6.1 The Contract (other than Buyer's obligation to pay all sums due to Seller in accordance with the Contract) shall be suspended, without liability, in the event and to the extent that its performance is prevented or delayed due to any circumstance beyond the reasonable control of the party affected, including but not limited to: Act of God, war, armed conflict or terrorist attack, riot, fire, explosion, accident, flood, sabotage; governmental decisions or actions (including but not limited to prohibition of exports or re-exports or the failure to grant or the revocation of applicable export licenses), or labor trouble, strike, lockout or injunction. Seller shall have no obligation to supply hardware, software or technology or to provide services in the absence of government permits or fulfillment of statutory conditions of exemption from such permits within the framework of import and export control (in particular, according to the regulations applicable in the United States, the European Union and the jurisdiction in which Seller has its registered office or from which components of the Goods are supplied) and the underlying circumstances could not be foreseen by Seller and are outside of Seller's sphere of influence. In the event of revocation of issued government permits or in the event of a change in the applicable statutory import and export control regulations such that Seller is prevented from fulfilling the contract, Seller is discharged from the contractual obligation without any liability of Seller.

6.2 If either party is delayed or prevented from performance of its obligations by reason of this Clause for more than 180 consecutive calendar days, either party may terminate the then unperformed portion of the Contract by notice in writing given to the other party, without liability provided that Buyer shall be obliged to pay the reasonable cost and expense of any work in progress and to pay for all Goods delivered and Services performed as at the date of termination.

7. INSPECTION, TESTING, AND CALIBRATION:

7.1 Goods will be inspected by Seller or manufacturer and, where practicable, submitted to Seller's or manufacturer's standard tests before dispatch. Any additional tests or inspection (including inspection by Buyer or its representative, or tests in the presence of Buyer or its representative and/or calibration) or the supply of test certificates and/or detailed test results shall be subject to Seller's prior written agreement and Seller reserves the right to charge therefor; if Buyer or its representative fails to attend such tests, inspection and/or calibration after seven days' notice that the Goods are ready therefor, the tests, inspection and/or calibration will proceed and shall be deemed to have been made in the presence of Buyer or its representative and the Seller's statement that the Goods have passed such testing and/or inspection and/or have been calibrated shall be conclusive.

7.2 Buyer's warranty rights are subject to Buyer's proper compliance with Buyer's inspection and complaint obligations set forth in Section 377 of the German Commercial Code (HGB).

8. DELIVERY, RISK & TITLE:

8.1 Unless otherwise expressly stated in the Contract, the Goods will be delivered Carriage Paid To (CPT) the destination named in the Contract; freight, packing and handling will be charged at Seller's standard rates. Risk of loss of or damage to the Goods shall pass to Buyer upon delivery as aforesaid and Buyer shall be responsible for insurance of the Goods after risk has so passed. Alternatively, if it is expressly stated in the Contract that Seller is responsible for the insurance of the Goods after their delivery to the carrier, such insurance will be charged at Seller's standard rates. "Ex-works", "FCA", "CPT" and any other delivery terms used in the Contract shall be defined in accordance with the latest version of Incoterms.

9. DOCUMENTATION AND SOFTWARE:

9.1 Title to and ownership of the copyrights in software and/or firmware incorporated into or provided for use with the Goods ("Software") and documentation supplied with the Goods ("Documentation") shall remain with the relevant Seller Affiliate (or such other party as may have supplied the Software and/or Documentation to Seller) and is not transferred hereby to Buyer.

9.2 Except as otherwise provided herein, Buyer is hereby granted a non-exclusive, royalty-free license to use the Software and Documentation in conjunction with the Goods, provided that and for so long as the Software and Documentation are not copied (unless expressly authorized by applicable law) and Buyer holds the Software and Documentation in strict confidence and does not disclose them to others, or permit others to have access to them (other than Seller's standard operating and maintenance manuals). Buyer may transfer the foregoing license to another party which purchases, rents or leases the Goods, provided the other party accepts and agrees in writing to be bound by the conditions of this Clause 9.

9.3 Notwithstanding Sub-clause 9.2, Buyer's use of certain Software, (as specified by Seller and including but not limited to control system and AMS Software) shall be governed exclusively by the applicable Seller Affiliate or third party license agreement.

9.4 Seller and Seller Affiliates shall retain ownership of all inventions, designs and processes made or evolved by them and save as set out in this Clause 9 no rights in intellectual property are hereby granted.

10. LIABILITY FOR DEFECTS OF QUALITY

10.1 Seller warrants that upon passing of the risk the Goods and Services will have the quality agreed upon. Unless otherwise agreed, the quality agreed upon shall meet Seller's specifications as valid and published at the time of the order confirmation.

10.2 If, upon passing of the risk, the Goods or Services do not have the quality agreed upon, Seller warrants to provide subsequent performance by either, at its option, repairing or replacing the concerned parts (subsequent rectification) or by replacing the Goods or Services by such Goods or Services which are free from defects (subsequent delivery).

10.3 Seller may rectify any defect several times and may decide at its discretion to change from rectification to subsequent delivery. Seller shall be responsible for all costs incurred in connection with its subsequent performance, especially the transport, shipping, labor and material cost, unless such costs are incurred as a result of the Goods being taken to a place other than the place of performance.

Emerson Climate Technologies GmbH
Registered Office:
Amtsgericht Berlin-Charlottenburg, HRB 8778

Emerson Climate Technologies GmbH, Emerson Retail Services Europe GmbH

10.4 Buyer may set a reasonable period of at least four (4) weeks to Seller for him to provide subsequent performance and, if subsequent performance fails during such period, may demand reduction of the Contract Price after expiry of that period or, unless the defect is insignificant, may rescind the Contract. Damages may only be claimed in line with Clause 14.

10.5 Any claims and rights based on defects will become time-barred, except in the case of intent, after expiry of twelve (12) months since taking into operation of the Goods, however no later than eighteen (18) months since delivery. Claims to damages based on defects will become time-barred after expiry of the statutory period if they result from a violation of another's life, health or body, or from Seller's gross negligence.

10.6 Seller assumes no warranty for normal wear and tear, material provided by Buyer, processing of the Goods made by Buyer, damage due to improper storage, installation or operation or due to inadequate maintenance, or damage resulting from any modification or repair not approved beforehand by Seller in writing. Seller will not be liable where any non-authorized software or non-authorized spare or replacement parts are used. Any costs incurred by Seller for examining and removing such defects will be borne by Buyer upon demand. Buyer will always be responsible alone for the completeness and correctness of any information provided by it.

10.7 Regarding products or Services sourced by Seller from a third party (other than a Seller Affiliate) for resale to Buyer, Seller assigns to Buyer all warranty rights against such third party. In addition, Seller remains obliged to assume the guarantee set forth the preceding clauses towards Buyer, however, only under the restriction that Buyer has beforehand unsuccessfully tried to execute the assigned warranty rights against the third party.

11. LIABILITY FOR PROPRIETARY RIGHTS INFRINGEMENTS

11.1 Seller warrants that upon passing of the risk no patents or other proprietary rights of third parties exist which may be claimed with respect to the Goods or Services if these are used as intended. Clauses 10.2 to 10.5 and 10.7 shall apply correspondingly.

11.2 Seller's liability shall be excluded where a third party patent or proprietary right is infringed because Seller has adhered to a design provided by Buyer or has complied with an instruction given by Buyer, or because the Goods are used in a manner, for a purpose, in a country, or in connection with other goods or services, without this having been communicated to Seller before execution of the Contract.

11.3 During the period of Seller's warranty, Buyer has the obligation to inform Seller in writing as promptly as possible in the event that a third party claims any patent or other proprietary right or asserts any claims in or out of court with respect to the Goods or Services. Before recognizing any claim advanced by a third party in or out of court, Buyer shall give Seller the opportunity to comment. At its request, Seller shall be given the authority to handle the negotiations or legal dispute with such third party at its own cost and responsibility. Buyer shall be liable to Seller for any damage sustained by it as a result of a culpable violation of said obligations.

11.4 Buyer warrants that the use of a design provided by it or compliance with an instruction given by it will not lead to Seller infringing any patents or other proprietary rights when performing its contractual obligations. Buyer agrees to indemnify and hold Seller harmless against any reasonable cost and damages incurred by Seller as a result of Buyer's breach of this warranty.

12. DAMAGES

12.1 Seller shall be liable to Buyer only for damage caused with intent or gross negligence. In the event of breach of material contractual obligations, Seller shall, however, be liable for each fault of its personnel (statutory representatives, executive employees and other persons employed in the performance of its obligations) causing damage.

12.2 Except in case of intentional causation of damage by personnel of Seller or causation of damage with gross negligence by statutory representatives or executive employees of Seller, Seller shall not be liable for compensation for indirect damage and, in particular, Seller shall not be liable for compensation for loss of profit, unless such damage is covered by the protective purpose of a warranty explicitly assumed.

12.3 Except in case of intentional causation of damage by personnel of Seller or causation of damage with gross negligence by statutory representatives or executive employees of Seller, the liability of Seller shall, in each case, be limited in terms of amount to the damage which is typically foreseeable in the time of conclusion of the contract.

12.4 Claims to damages which result from the violation of another's life, body or health, from the violation of a guaranty given by Seller expressly in writing as well as damage claims under the Product Liability Act shall remain unaffected.

13. STATUTORY AND OTHER REGULATIONS:

13.1 If Seller's obligations under the Contract shall be increased or reduced by reason of the making or amendment after the date of Seller's quotation of any law or any order, regulation or by-law having the force of law that shall affect the performance of Seller's obligations under the Contract, the Contract Price and delivery period shall be adjusted accordingly and/or performance of the Contract suspended or terminated, as appropriate. A price adjustment shall not be implemented if the delivery is to be carried out within 4 months after the closing of the Contract.

13.2 Except to the extent otherwise required by applicable law, Seller shall have no responsibility for the collection, treatment, recovery or disposal of (i) the Goods or any part thereof when they are deemed by law to be "waste" or (ii) any items for which the Goods or any part thereof are replacements. If Seller is required by applicable law, including waste electrical and electronic equipment legislation, European Directive 2002/96/EC (WEEE) and related legislation in EU Member States, to dispose of "waste" Goods or any part thereof, Buyer shall, unless prohibited by applicable law, pay Seller, in addition to the Contract Price, either (i) Seller's standard charge for disposing of such Goods or (ii) if Seller does not have such a standard charge, Seller's costs (including all handling, transportation and disposal costs and a reasonable mark-up for overhead) incurred in disposing of such Goods.

13.3 Buyer's personnel shall, whilst on Seller's premises, comply with Seller's applicable site regulations and Seller's reasonable instructions, including but not limited to those relating to safety, security and electrostatic discharge.

14. COMPLIANCE WITH LAWS

Buyer agrees that all applicable import, export control and sanctions laws, regulations, orders and requirements, as they may be amended from time to time, including without limitation those of the United States, the European Union and the jurisdictions in which Seller and Buyer are established or from which items may be supplied, and the requirements of any licenses, authorizations, general licenses or license exceptions relating thereto will apply to its receipt and use of hardware, software, services and technology. In no event shall Buyer use, transfer, release, export or re-export any such hardware, software or technology in violation of such applicable laws, regulations, orders or requirements or the requirements of any licenses, authorizations or license exceptions relating thereto. Buyer agrees furthermore that it shall not engage in any activity that would expose the Seller or any of its affiliates to a risk of penalties under laws and regulations of any relevant jurisdiction prohibiting improper payments, including but not limited to bribes, to officials of any government or of any agency, instrumentality or political subdivision thereof, to political parties or political party officials or candidates for public office, or to any employee of any customer or supplier. Buyer agrees to comply with all appropriate legal, ethical and compliance requirements.

15. DEFAULT, INSOLVENCY AND CANCELLATION:

Seller shall be entitled, without prejudice to any other rights it may have, to cancel the Contract forthwith, wholly or partly, by notice in writing to Buyer, if Buyer is in default of any of its obligations under the Contract and fails, within 30 (thirty) days of the date of Seller's notification in writing of the existence of the default, either to rectify such default if it is reasonably capable of being rectified within such period or, if the default is not reasonably capable of being rectified within such period, to take action to remedy the default.

16. SUPPLEMENTARY TERMS AND CONDITIONS:

If the Goods comprise or include a control system, Seller's Supplementary Terms and Conditions Applicable to the Supply of Control Systems and Related Services shall apply to the control system and related services only. Such Supplementary Terms and Conditions shall take precedence over these Standard Terms and Conditions of Sale; copies are available from Seller upon request.

17. MISCELLANEOUS:

17.1 No waiver by either party with respect to any breach or default or of any right or remedy and no course of dealing, shall be deemed to constitute a continuing waiver of any other breach or default or of any other right or remedy, unless such waiver be expressed in writing and signed by the party to be bound.

17.2 If any clause, sub-clause or other provision of the Contract is invalid or unenforceable, this shall not affect the validity of the remainder of the Contract. Should one of the clauses be invalid or unenforceable, the parties obligate themselves to replace the invalid or unenforceable clause by such a clause which comes closest to the intended economic purpose of the invalid clause.

17.3 Buyer shall not be entitled to assign its rights or obligations hereunder without the prior written consent of Seller.

17.4 Seller enters into the Contract as principal. Buyer agrees to look only to Seller for due performance of the Contract.

17.5 GOODS AND SERVICES PROVIDED HEREUNDER ARE NOT SOLD OR INTENDED FOR USE IN ANY NUCLEAR OR NUCLEAR RELATED APPLICATIONS. Buyer (i) accepts Goods and Services in accordance with the foregoing restriction, (ii) agrees to communicate such restriction in writing to any and all subsequent purchasers or users and (iii) agrees to defend, indemnify and hold harmless Seller and Seller's Affiliates from any and all claims, losses, liabilities, suits, judgements and damages, including incidental and consequential damages, arising from use of Goods and Services in any nuclear or nuclear related applications, whether the cause of action be based in tort, contract or otherwise, including allegations that the Seller's liability is based on negligence or strict liability.

17.6 The Contract shall in all respects be construed in accordance with the laws of the Federal Republic of Germany excluding, however, any effect on such laws of the 1980 Vienna Convention on Contracts for the International Sale of Goods, and to the fullest extent permitted by law, shall be without regard to any conflict of laws or rules which might apply the laws of any other jurisdiction. All disputes arising out of the Contract shall be subject to the exclusive jurisdiction of the Berlin courts. However, Seller is entitled to sue Buyer in the court of Buyer's residence as well.

17.7 The headings to the Clauses and paragraphs of the Contract are for guidance only and shall not affect the interpretation thereof.

17.8 All notices and claims in connection with the Contract must be in writing.

Emerson Retail Services Europe GmbH
Registered Office:
Amtsgericht Berlin-Charlottenburg, HRB 81171

BENELUX

Josephinastraat 19
NL-6462 EL Kerkrade
Tel: +31 45 535 06 73
Fax: +31 45 535 06 71
benelux.sales@emerson.com

GERMANY, AUSTRIA & SWITZERLAND

Senefelder Str. 3
DE-63477 Maintal
Tel: +49 6109 605 90
Fax: +49 6109 60 59 40
ECTGermany.sales@emerson.com

FRANCE, GREECE & MAGHREB

8, Allée du Moulin Berger
FR-69134 Ecully Cédex, Technoparc - CS 90220
Tel: +33 4 78 66 85 70
Fax: +33 4 78 66 85 71
mediterranean.sales@emerson.com

ITALY

Via Ramazzotti, 26
IT-21047 Saronno (VA)
Tel: +39 02 96 17 81
Fax: +39 02 96 17 88 88
italy.sales@emerson.com

SPAIN & PORTUGAL

C/ Pujades, 51-55 Box 53
ES-08005 Barcelona
Tel: +34 93 412 37 52
Fax: +34 93 412 42 15
iberica.sales@emerson.com

CZECH REPUBLIC

Hajkova 22
CZ - 133 00 Prague
Tel: +420 733 161 651
Fax: +420 271 035 655
Pavel.Sudek@emerson.com

ROMANIA

Tel. +40 374 13 23 50
Fax +40 374 13 28 11
Blanka.Erdo@Emerson.com

ASIA PACIFIC

Suite 2503-8, 25/F., Exchange Tower
33 Wang Chiu Road, Kowloon Bay
Kowloon, Hong Kong
Tel: +852 2866 3108
Fax: +852 2520 6227

UK & IRELAND

Unit 17, Theale Lakes Business Park
Reading, Berkshire RG7 4GB
Tel: +44 1189 83 80 00
Fax: +44 1189 83 80 01
uk.sales@emerson.com

SWEDEN, DENMARK, NORWAY & FINLAND

Pascalstr. 65
DE-52076 Aachen
Tel: +49 2408 929 0
Fax: +49 2408 929 525
nordic.sales@emerson.com

EASTERN EUROPE & TURKEY

Pascalstr. 65
DE-52076 Aachen
Tel: +49 2408 929 0
Fax: +49 2408 929 525
easterneurope.sales@emerson.com

POLAND

Szturmowa 2
PL-02678 Warsaw
Tel. +48 22 458 92 05
Fax +48 22 458 92 55
poland.sales@emerson.com

RUSSIA & CIS

Dubininskaya 53, bld. 5
RU-115054, Moscow
Tel: +7 - 495 - 995 95 59
Fax: +7 - 495 - 424 88 50
ECT.Holod@emerson.com

BALKAN

Selska cesta 93
HR-10 000 Zagreb
Tel: +385 1 560 38 75
Fax: +385 1 560 38 79
balkan.sales@emerson.com

MIDDLE EAST & AFRICA

PO Box 26382
Jebel Ali Free Zone - South, Dubai - UAE
Tel: +971 4 811 81 00
Fax: +971 4 886 54 65
mea.sales@emerson.com

For more details, see www.emersonclimate.eu
Connect with us: facebook.com/EmersonCommercialResidentialSolutions



Emerson Commercial & Residential Solutions

Emerson Climate Technologies GmbH - Pascalstrasse 65 - 52076 Aachen, Germany
Tel. +49 (0) 2408 929 0 - Fax: +49 (0) 2408 929 570 - Internet: www.emersonclimate.eu

The Emerson logo is a trademark and service mark of Emerson Electric Co. Emerson Climate Technologies Inc. is a subsidiary of Emerson Electric Co. Copeland is a registered trademark and Copeland Scroll is a trademark of Emerson Climate Technologies Inc.. All other trademarks are property of their respective owners. Emerson Climate Technologies GmbH shall not be liable for errors in the stated capacities, dimensions, etc., as well as typographic errors. Products, specifications, designs and technical data contained in this document are subject to modification by us without prior notice. Illustrations are not binding.
© 2018 Emerson Climate Technologies, Inc.



EMERSON™

EMERSON. CONSIDER IT SOLVED.™